

basic education

Department:
Basic Education
REPUBLIC OF SOUTH AFRICA

SENIOR CERTIFICATE EXAMINATIONS/ NATIONAL SENIOR CERTIFICATE EXAMINATIONS

LIFE SCIENCES P1

2021

MARKS: 150

TIME: 2½ hours

This question paper consists of 17 pages.



INSTRUCTIONS AND INFORMATION

Read the following instructions carefully before answering the questions.

1. Answer ALL the questions.
2. Write ALL the answers in the ANSWER BOOK.
3. Start the answer to EACH question at the top of a NEW page.
4. Number the answers correctly according to the numbering system used in this question paper.
5. Present your answers according to the instructions of each question.
6. Do ALL drawings in pencil and label them in blue or black ink.
7. Draw diagrams, tables or flow charts only when asked to do so.
8. The diagrams in this question paper are NOT necessarily drawn to scale.
9. Do NOT use graph paper.
10. You must use a non-programmable calculator, protractor and a compass, where necessary.
11. Write neatly and legibly.



SECTION A**QUESTION 1**

1.1 Various options are provided as possible answers to the following questions. Choose the answer and write only the letter (A to D) next to the question numbers (1.1.1 to 1.1.10) in the ANSWER BOOK, e.g. 1.1.11 D.

1.1.1 The function of the epididymis is to ...

- A produce semen.
- B transport sperm to the urethra.
- C produce sperm.
- D store sperm until maturation.

1.1.2 Which ONE of the following is an exocrine gland?

- A Pituitary
- B Prostate
- C Adrenal
- D Thyroid

1.1.3 A list of the functions of the brain is provided below:

- (i) Interprets sensation
- (ii) Regulates involuntary actions
- (iii) Controls higher thought processes
- (iv) Controls voluntary actions

Which ONE of the following combinations are the functions of the cerebrum?

- A (ii) and (iii) only
- B (i), (ii), (iii) and (iv)
- C (i), (iii) and (iv) only
- D (i) and (ii) only



1.1.4 An acrosome has ...

- A mitochondria to produce energy for the movement of sperm.
- B a chromatin network that carries genes.
- C enzymes needed to penetrate the ovum.
- D a tail to facilitate the movement of sperm.

1.1.5 Ovulation is stimulated by an increase in the levels of ...

- A progesterone.
- B LH.
- C FSH.
- D oestrogen.



1.1.6 Barotrauma is a common condition that occurs when pressure builds up in the middle ear. This causes the tympanic membrane to bulge. It is most common among deep-sea divers.

Divers are advised against diving when they have a middle-ear infection because the ...

- A auditory canal cannot equalise the pressure in the middle ear.
- B Eustachian tube is blocked and air cannot enter the middle ear.
- C tympanic membrane is hardened and cannot pass the vibrations onto the middle ear.
- D ossicles are fused together and cannot vibrate freely in the middle ear.

1.1.7 Which ONE of the following shows the correct combination of the hormone with its target organ?

	HORMONE	TARGET ORGAN
A	Prolactin	Pituitary gland
B	Glucagon	Pancreas
C	LH	Uterus
D	TSH	Thyroid gland

1.1.8 Oogenesis takes place in the ...

- A uterus.
- B ovary.
- C cervix.
- D vagina.

1.1.9 A learner conducted an investigation to determine the effect of caffeine on reaction time.

The procedure was done as follows:

- 50 male volunteers of the same age participated.
- Their reaction times were measured using a computer program.
- They were all given 200 ml of an energy drink that contained caffeine.
- Their reaction times were measured again every 10 minutes for 2 hours.

Which ONE of the following increased the reliability of the results obtained?

- A Gender of the volunteers
- B Age of the volunteers
- C 50 volunteers used
- D Type of caffeine used



- 1.1.10 An investigation was done in which a potted plant was placed horizontally on a clinostat, as shown in the diagram. The plant was exposed to uniform light from all directions.

(A clinostat is a device with a disc that rotates when switched on, allowing the attached plant to rotate as well.)

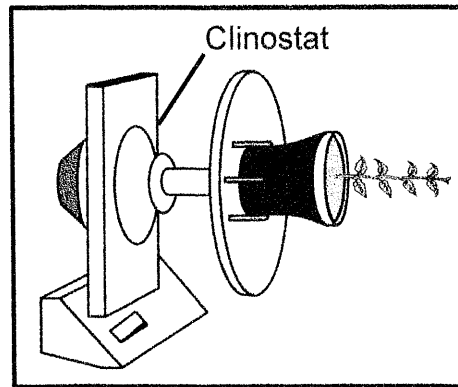

The stem grew vertically upwards, which indicates that the clinostat was ...

- A stationary and the stem showed negative geotropism.
- B rotating and the stem showed positive geotropism.
- C stationary and the stem showed negative phototropism.
- D rotating and the stem showed positive phototropism. (10 x 2) **(20)**



1.2 Give the correct **biological term** for each of the following descriptions. Write only the term next to the question numbers (1.2.1 to 1.2.9) in the ANSWER BOOK.

- 1.2.1 The planting of the same crop on the same land repeatedly
- 1.2.2 The permanent removal of trees and vegetation from an area
- 1.2.3 A part of the male reproductive system used to transfer semen to the female
- 1.2.4 The part of the nervous system that is made up of spinal and cranial nerves
- 1.2.5 A type of vision in which both eyes are used together to focus on an object
- 1.2.6 The structure that the Graafian follicle develops into after ovulation
- 1.2.7 A functional gap between two consecutive neurons
- 1.2.8 An underground permeable rock that stores water
- 1.2.9 The hormone that stimulates puberty in females (9 x 1) (9)

1.3 Indicate whether each of the descriptions in COLUMN I apply to **A ONLY**, **B ONLY**, **BOTH A AND B** or **NONE** of the items in COLUMN II. Write **A only**, **B only**, **both A and B** or **none** next to the question numbers (1.3.1 to 1.3.3) in the ANSWER BOOK.

COLUMN I		COLUMN II
1.3.1	A factor that reduces food security	A: Floods B: Drought
1.3.2	The part of a neuron that speeds up the transmission of an impulse	A: Myelin sheath B: Axon
1.3.3	A factor that impacts on biodiversity	A: Poaching B: Habitat destruction

(3 x 2) (6)



1.4 The diagram below represents a part of the human ear.

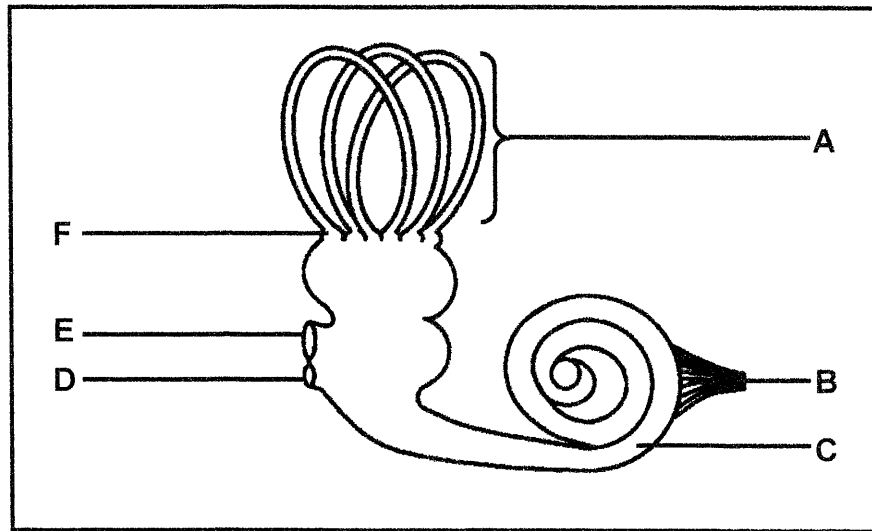

1.4.1 Identify part:

(a) **A**

(1)

(b) **B**

(1)



1.4.2 Give the LETTER and NAME of the part that:

(a) Creates pressure waves in the fluid of the inner ear

(2)

(b) Absorbs excess pressure waves in the inner ear to prevent the formation of an echo

(2)

1.4.3 Name the:

(a) Part of the brain that interprets impulses from part F

(1)

(b) Receptors found at C

(1)

(8)



1.5 A boy steps on a nail and pulls his leg away suddenly. The diagram below shows the pathway taken to create this reaction.

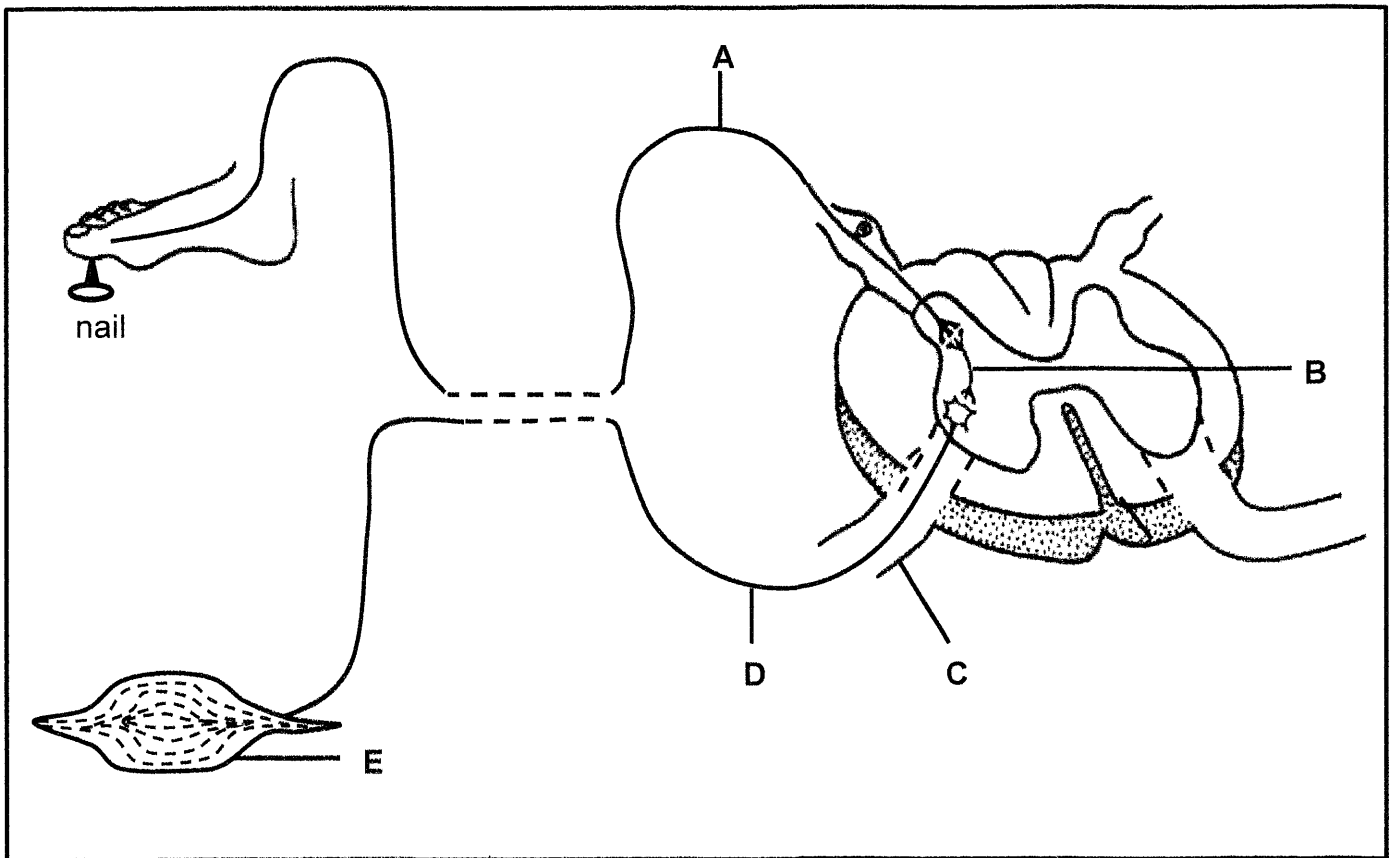

- 1.5.1 Name the pathway represented by the diagram. (1)
- 1.5.2 Give ONE advantage of this type of reaction. (1)
- 1.5.3 Identify part:
- (a) **B** (1)
 - (b) **C** (1)
 - (c) **E** (1)
- 1.5.4 Give the LETTER and NAME of the neuron that transports impulses towards the spinal cord. (2)

TOTAL SECTION A: 50



SECTION B

QUESTION 2

2.1 The diagram below shows a phase during meiosis in an animal cell.

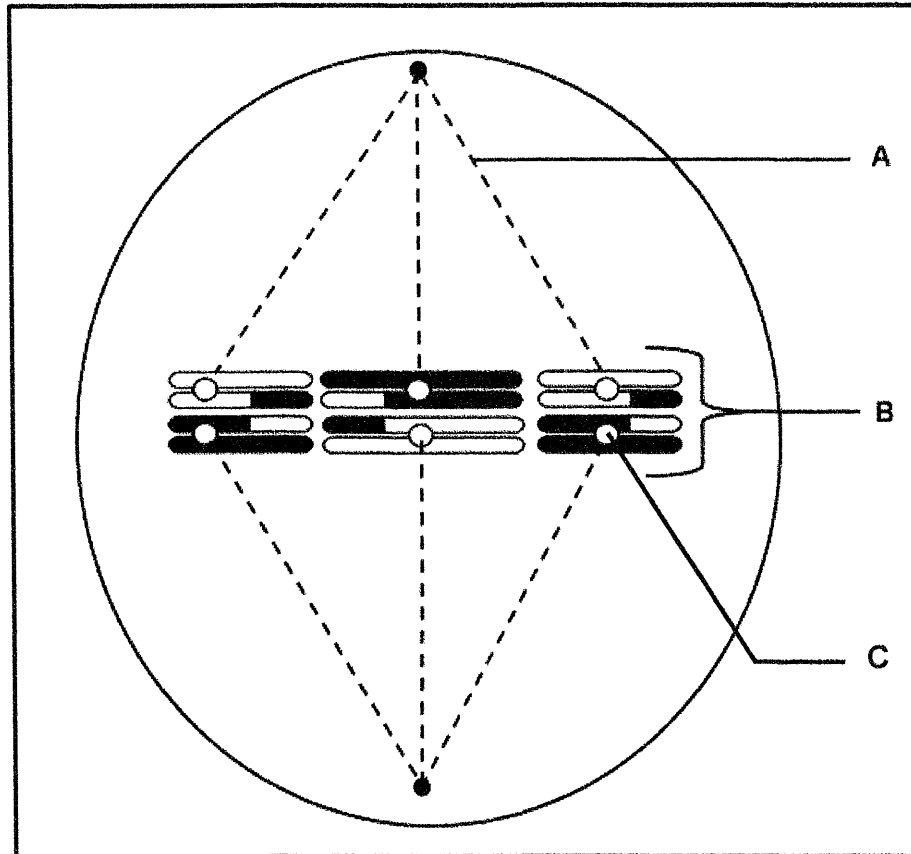

2.1.1 Identify part **C**. (1)

2.1.2 Name the phase represented in the diagram. (1)

2.1.3 **B** represents homologous chromosomes.

What are *homologous chromosomes*? (2)

2.1.4 Explain the appearance of the chromosomes in the diagram. (3)

2.1.5 State the function of part **A** in the phase following the one represented in the diagram. (1)

2.1.6 The total amount of DNA is 12 arbitrary units in each daughter cell at the end of this cell division.

How much DNA (in arbitrary units) was in the parent cell at the beginning of the cell division? (2)

(10)



2.2 The diagram below represents a part of the human skin.

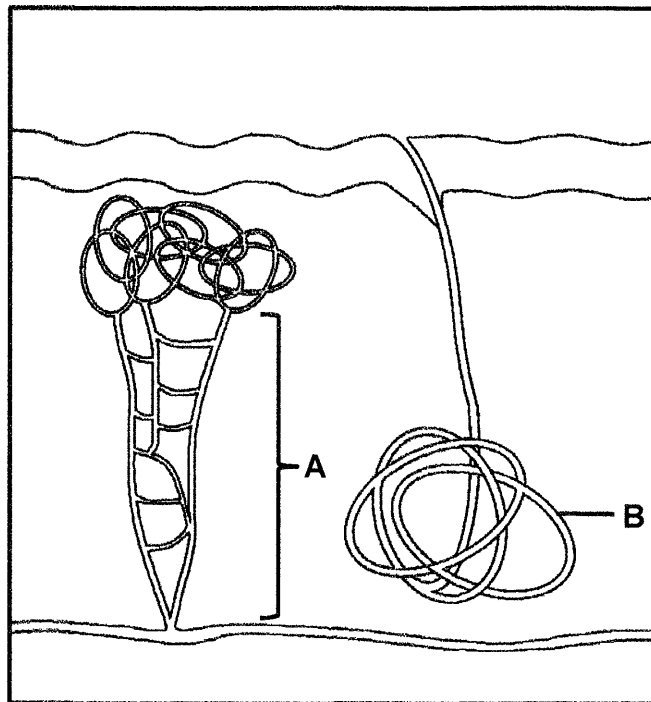

2.2.1 Identify part **B**. (1)

2.2.2 Describe how structure **A** functions during thermoregulation on a cold day. (3)

2.2.3 Explain why temperature needs to be kept constant in the human body. (2)
(6)

2.3 ADH plays a role in osmoregulation in the human body.

2.3.1 Name the gland that secretes ADH. (1)

2.3.2 Describe osmoregulation on a cold day. (3)

2.3.3 A person with a medical condition that causes the renal tubules to become resistant to the effects of ADH, always produces large volumes of urine.

Explain why the ADH levels in the blood will always be higher than normal for this person. (3)
(7)



2.4 Read the extract below.

REPRODUCTION IN GUPPY FISH

Guppy fish have a very interesting method of breeding. During mating the male deposits packets of sperm inside the female's reproductive opening using an organ called the 'gonopodium'. This process takes place several times and the female stores some of the extra sperm.

The fertilised eggs remain in the female's body until they hatch and the young are born live. The gestation period is usually between 22 and 28 days.

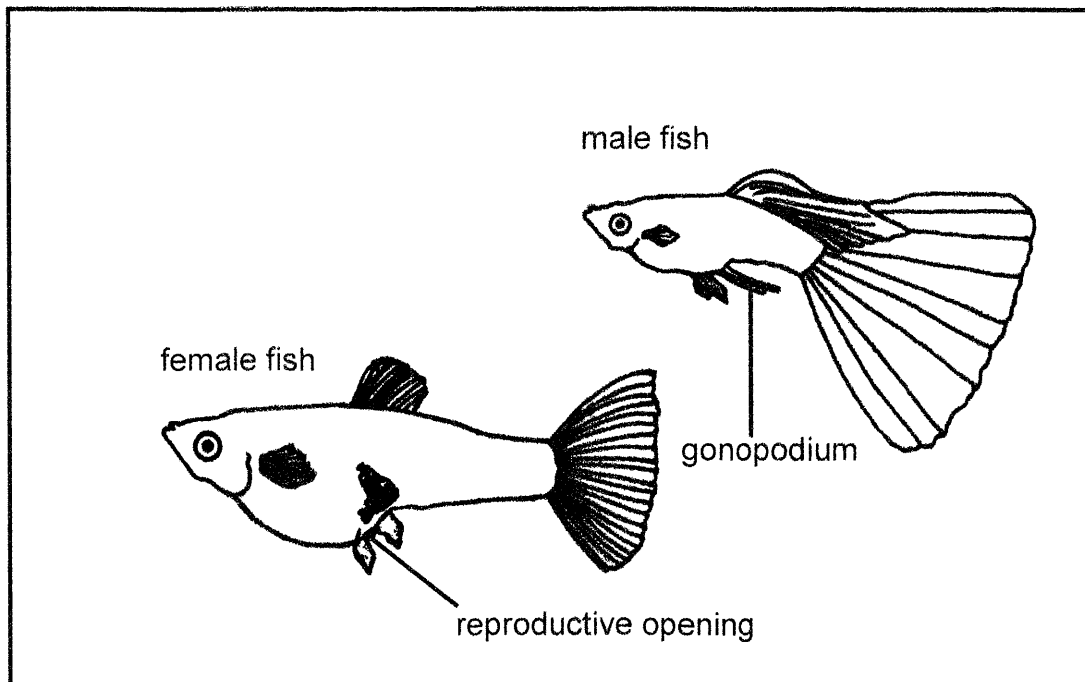

- 2.4.1 Name the type of fertilisation in guppies. (1)
- 2.4.2 Explain TWO ways in which the type of fertilisation named in QUESTION 2.4.1 increases reproductive success. (4)
- 2.4.3 Why are guppies regarded as being ovoviviparous? (2)
- (7)



2.5 Premature delivery of babies (babies born between weeks 28 to 35 of gestation) has been a concern in many countries. The care of premature babies is very costly. Women with a history of premature delivery are sometimes given a progesterone treatment between weeks 16 to 20 of pregnancy.

However, this treatment is believed to lead to the development of gestational diabetes mellitus in the mother.

An investigation was done to determine if progesterone treatment leads to the development of gestational diabetes mellitus.

The procedure was as follows:

- 300 pregnant women with a history of premature delivery participated in the investigation (those that had pre-existing diabetes mellitus were excluded).
- The women were divided into two equal groups (Group A and Group B).
- The women in Group A were injected once a week with 250 mg of progesterone between weeks 16 and 20.
- Their glucose levels were measured and recorded daily between week 16 and 36 of the pregnancy.
- Group B was the control.

- 2.5.1 Why is the injection of progesterone a good treatment to prevent premature delivery? (2)
- 2.5.2 Identify the:
- (a) Independent variable (1)
- (b) Dependent variable (1)
- 2.5.3 Describe how the investigators determined whether any of the participants in Group **A** had developed gestational diabetes mellitus. (2)
- 2.5.4 State TWO factors that were kept constant when the progesterone was administered in Group **A**. (2)
- 2.5.5 Group **B** was the control.
- Explain the importance of group **B** in this investigation. (2)
- (10)**
[40]





QUESTION 3

3.1 The diagram below represents a type of visual defect.

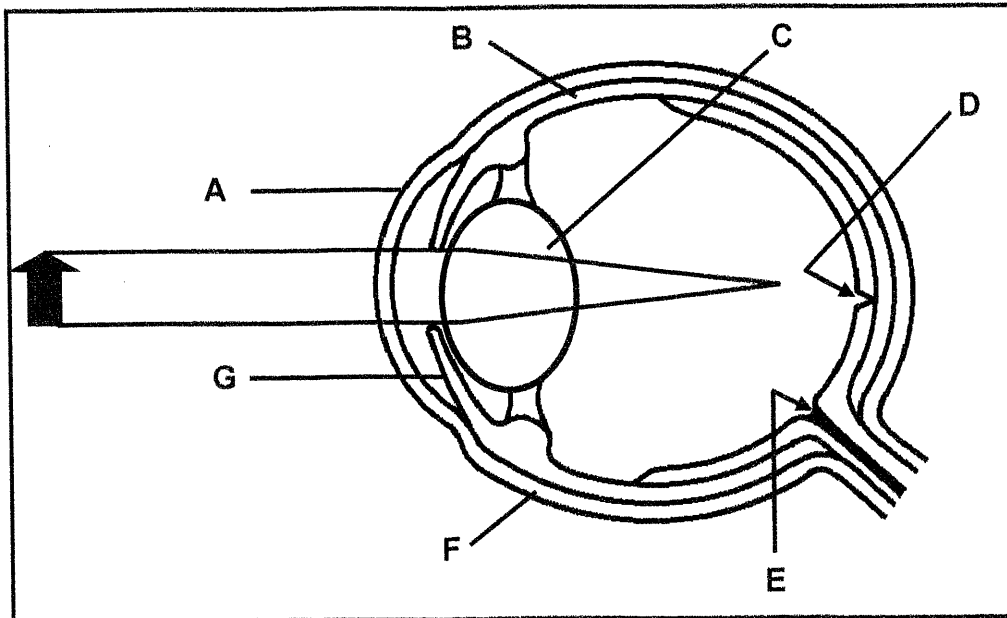

- 3.1.1 Identify part **F**. (1)
 - 3.1.2 State ONE function of part **B**. (1)
 - 3.1.3 Explain why the light rays must focus on part **D** rather than on part **E**. (4)
 - 3.1.4 Name the type of lens that is used to correct the visual defect shown in the diagram. (1)
 - 3.1.5 Describe how the type of lens named in QUESTION 3.1.4 corrects the visual defect. (2)
 - 3.1.6 Explain ONE way in which part **C** is structurally suited for accommodation. (2)
 - 3.1.7 Name the TWO muscles found in part **G**. (2)
 - 3.1.8 Name and describe the visual defect that occurs when part **A** is uneven. (3)
- (16)**

3.2 Read the extract below.

AUXINS CAN BE USED AS SELECTIVE HERBICIDES

Auxins stimulate plant growth, however, a high concentration of auxins may cause the plant to grow too fast. The plant is not able to sustain this rapid growth and as a result, it will die.

Farmers spray artificially manufactured auxins onto the surface of weeds to kill them. This type of herbicide (weed killer) is selective as it kills mainly the broad-leafed dicotyledonous plants without having any effect on narrow-leafed monocotyledonous plants, such as wheat, maize and grass.

Auxin-based herbicides are more environmentally friendly. Other herbicides may kill some organisms and the chemicals from these herbicides accumulate in the food chains, thus disturbing the ecosystems.

- 3.2.1 State ONE way in which auxins cause growth in plants. (1)
- 3.2.2 Explain why farmers would want to kill the weeds in their fields. (2)
- 3.2.3 According to the extract, state ONE disadvantage of using herbicides that are not auxin-based. (1)
- 3.2.4 Give ONE reason for using auxin-based herbicides instead of physically removing the weeds. (2)
- 3.2.5 A farmer planted maize and beans (broad-leafed plants) in her field.
- Explain why the farmer should not use an auxin-based herbicide in her field. (2)
- (8)**



- 3.3 Livestock farming contributes to approximately 14,6% of all global greenhouse gas emissions (release into atmosphere).

The graph below shows the global greenhouse gas emissions of different types of livestock.

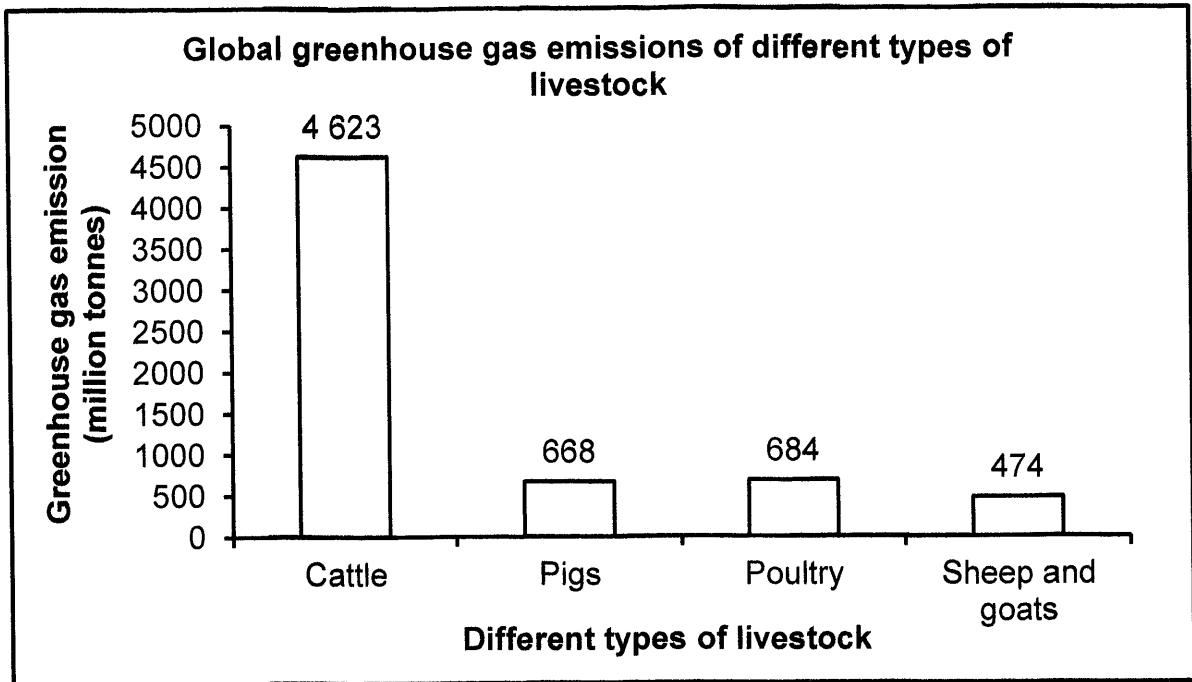

- 3.3.1 Name the livestock farming that contributes the least to greenhouse gas emissions. (1)
- 3.3.2 Give ONE advantage of greenhouse gases. (1)
- 3.3.3 Calculate how much more greenhouse gases are emitted by cattle compared to all other types of livestock combined. Show ALL your workings. (2)
- 3.3.4 One of the greenhouse gases emitted by livestock is methane.
Name ONE other source of methane. (1)
- 3.3.5 Explain why an increase in livestock farming may lead to global warming. (3)
- (8)**

3.4 A factory was built on the banks of a river close to a fishing village. The factory used water from the river to cool down the machinery. The water was then released back into the river causing thermal pollution.

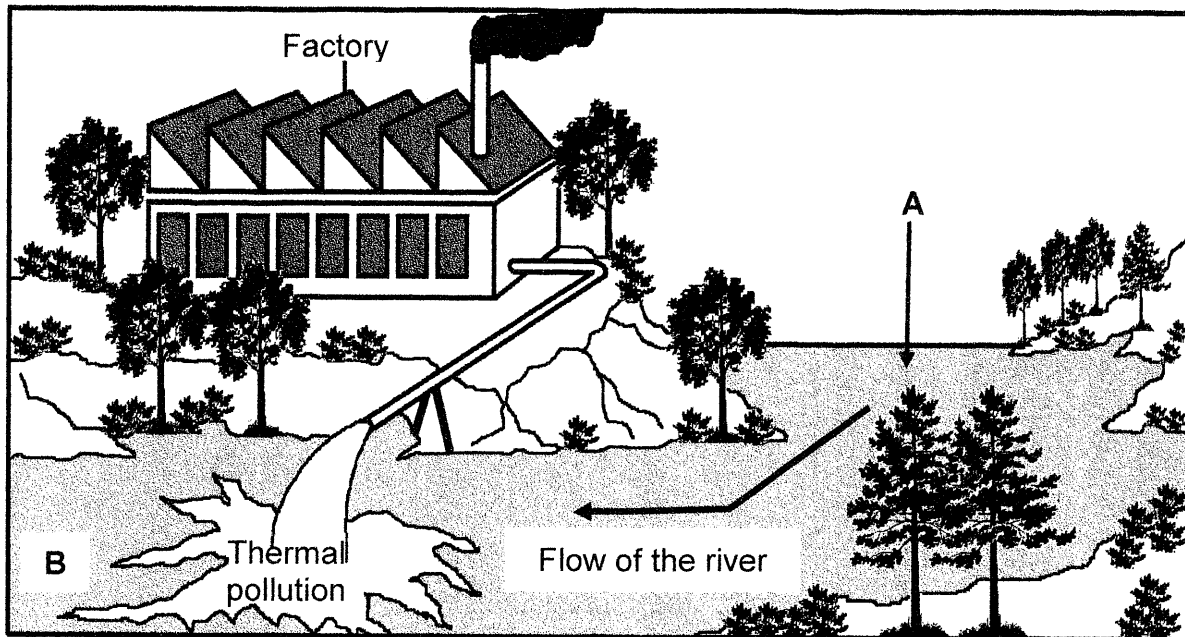

- 3.4.1 What is *thermal pollution*? (1)
- 3.4.2 Describe how thermal pollution affects the water quality. (2)
- 3.4.3 Suggest ONE way in which the factory can reduce thermal pollution. (1)
- 3.4.4 How will thermal pollution affect the fishermen in the village, economically? (2)
- 3.4.5 During the lockdown of the country due to Covid-19 restrictions, the factory was closed for a period of 4 months.
- Suggest, with a reason, the impact that this would have had on the biodiversity in area B. (2)

(8)
[40]

TOTAL SECTION B: 80



SECTION C

QUESTION 4

Describe the events that lead to pregnancy from the time a zygote is formed, up to the formation of the foetus including the development of the placenta and umbilical cord.

Content: (17)
Synthesis: (3)
(20)

NOTE: NO marks will be awarded for answers in the form of flow charts, tables or diagrams.

TOTAL SECTION C: 20
GRAND TOTAL: 150



Downloaded from Stanmorephysics.com