



**ISEBE LEMFUNDO LEMPUMA KOLONI
EASTERN CAPE EDUCATION DEPARTMENT
OOS-KAAP ONDERWYSDEPARTEMENT**

NASIONALE SENIOR SERTIFIKAAT



GRAAD 12

INGENIEURSGRAFIKA EN -ONTWERP V2

SEPTEMBER 2020

**VOORBEREIDINGS EKSAMEN
NASIENRIGLYNE**

PUNTE: 200

TYD: 3 uur

Die nasienriglyne bestaan uit 6 bladsye.

Kopiereg voorbehou

VRAAG 1: ANALITIES (MEGANIES)

ANTWOORDE		
1	AMATHOLE	1
2	043 7640 488	1
3	120	1
4	REDDY	1
5	VSK Ø3 GAT IN STAAF	1
6	VERSINK	1
7	OLIE GAT (SMEERMIDDEL)	1
8	VIERKANT	1
9	BRONS	1
10	14	1
11	BO-AANSIG	2
12	VOLSNIT	2
13	HALFSNIT	2
14	GEWENTELDE SNIT	1
15	Ø5	2
	Ø6	2
	Ø2	2
	$25 + 195 + 15 = 235$	2
16		4
TOTAAL		29

ANTWOORD 16

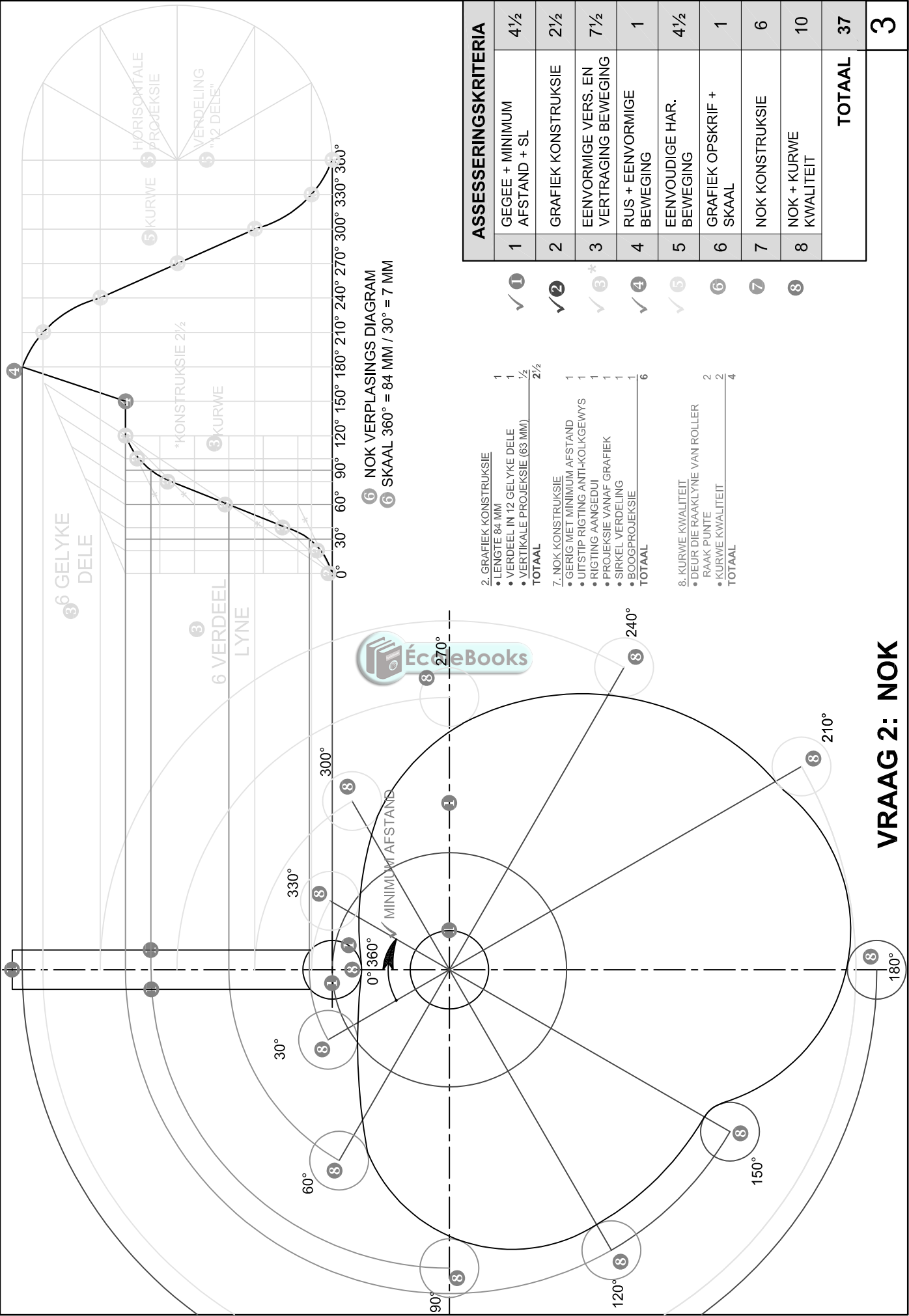

ASSESSERINGSKRITERIA	
1	GEGEE + MINIMUM AFSTAND + SL
2	GRAFIEK KONSTRUKSIE
3	EENVORMIGE VERS. EN VERTRAGING BEWEGING
4	RUS + EENVORMIGE BEWEGING
5	EENVOUDIGE HAR. BEWEGING
6	GRAFIEK OPSKRIF + SKAAL
7	NOK KONSTRUKSIE
8	NOK + KURWE KWALITEIT
TOTAAL	
	37

- 1 ✓
 - 2 ✓
 - 3 ✓*
 - 4 ✓
 - 5 ✓
 - 6 ✓
 - 7 ✓
 - 8 ✓
2. GRAFIEK KONSTRUKSIE
- LENGTE 84 MM
 - VERDEEL IN 12 GELYKE DELE
 - VERTIKALE PROEKSIE (63 MM)
- TOTAAL 1 1/2 2 1/2
7. NOK KONSTRUKSIE
- GERIG MET MINIMUM AFSTAND
 - UITSTIP RIGTING ANTI-KOLKGEWYS
 - RIGTING AANGEDUI
 - PROEKSIE VANAF GRAFIEK
 - SIRKEL VERDELING
 - BOOGPROEKSIE
- TOTAAL 1 1 1 1 1 6
8. KURWE KWALITEIT
- DEUR DIE RAAKLYNE VAN ROLLER
 - RAAK PUNTE
 - KURWE KWALITEIT
- TOTAAL 2 2 4

VRAAG 2: NOK

VRAAG 3: ISOMETRIES

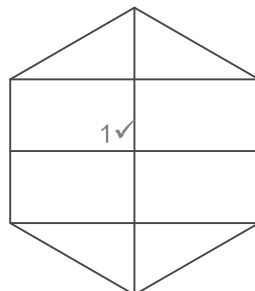
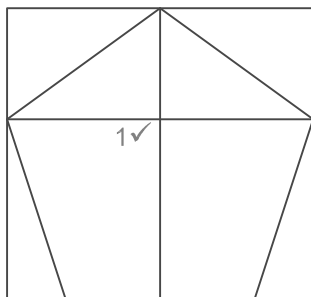
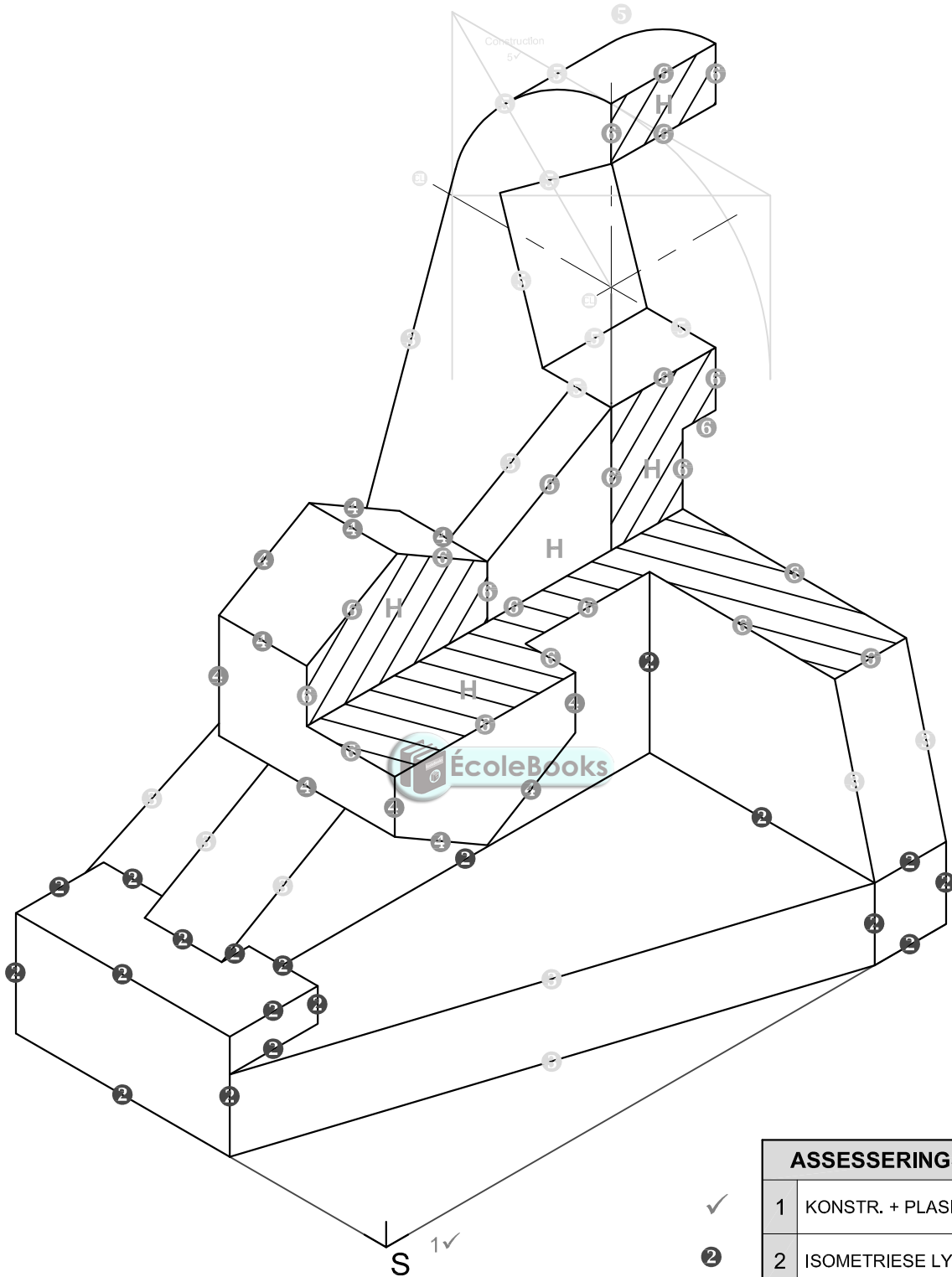

ASSESSERINGSKRITERIA		
✓ 1	KONSTR. + PLASING	3
2	ISOMETRIESE LYNE	9½
3	WEB	4½
4	SESHOEK	5½
5	SIRKEL + VYFHOEK	6
6 H	SNYVLAK + ARSERING	13½
TOTAAL		42

4

VRAAG 4: MEGANIESE SAMESTELLING

DEURSNEE VOORAANSIG VAN SNYVLAK A-A

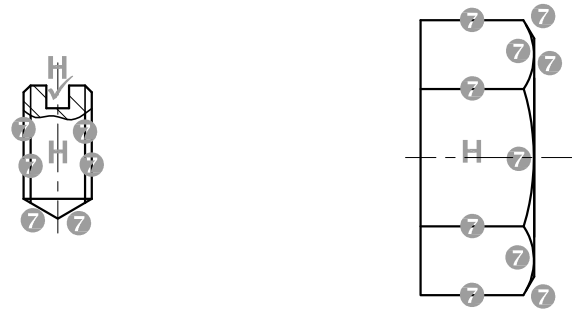
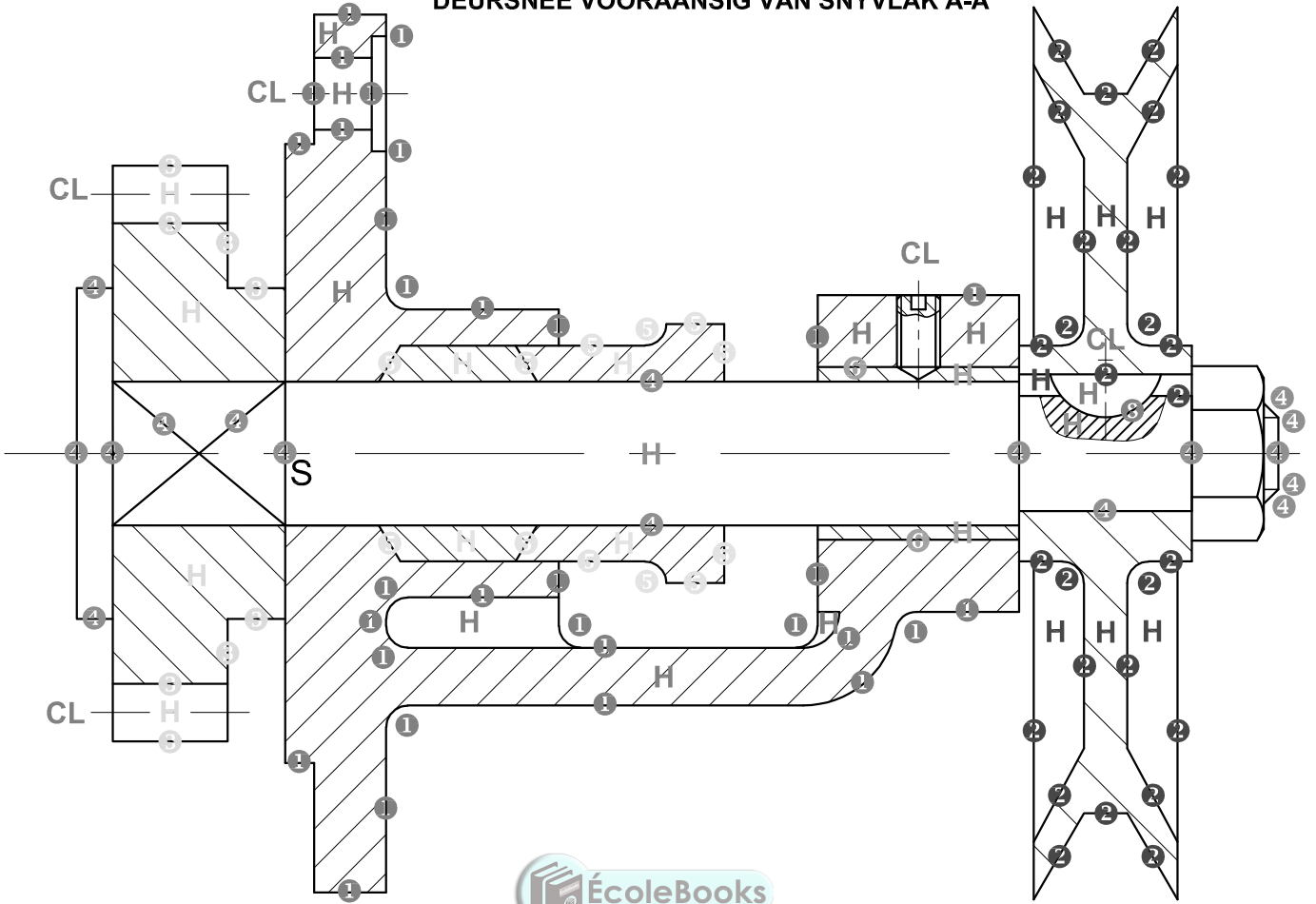

ASSESSERINGSKRITERIA			
DEURSNEE VOORAANSIG			
① H	1	HULS	20
② H	2	KATROL	17½
③ H	3	RAT	6
④ H	4	AS	9½
⑤ H	5	STUT + PAKSTUK	8
⑥ H	6	BUS	2
⑦ H	7	M14-MOER + GRYPKROEF	10½
⑧ H	8	SPY	1
CL	9	SENTERLYNE	2½
	10	SAMESTELLING	4½
SUB-TOTAAL			81½

5

VRAAG 4: MEGANIESE SAMESTELLING

REGTERAANSIG

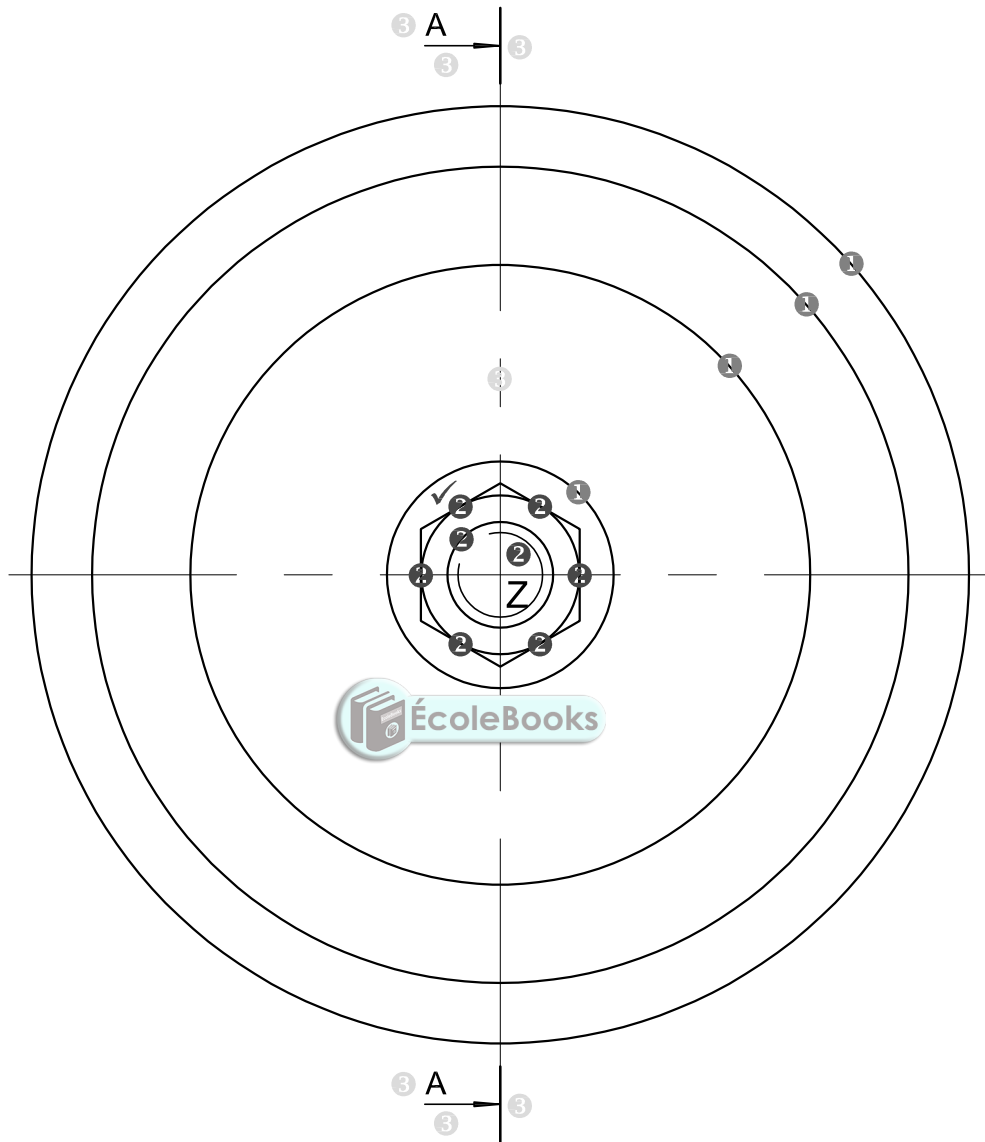

ASSESSERINGSKRITERIA			
REGTERAANSIG			
①	1	KATROL	2
✓ ②	2	M14-MOER	5
③	3	SNYVLAK	3½
SUB-TOTAAL			10½

6