

Download more resources like this on ECOLEBOOKS.COM

Natural Sciences Teacher's Guide

Grade 9-B (CAPS)

sasol
reaching new frontiers

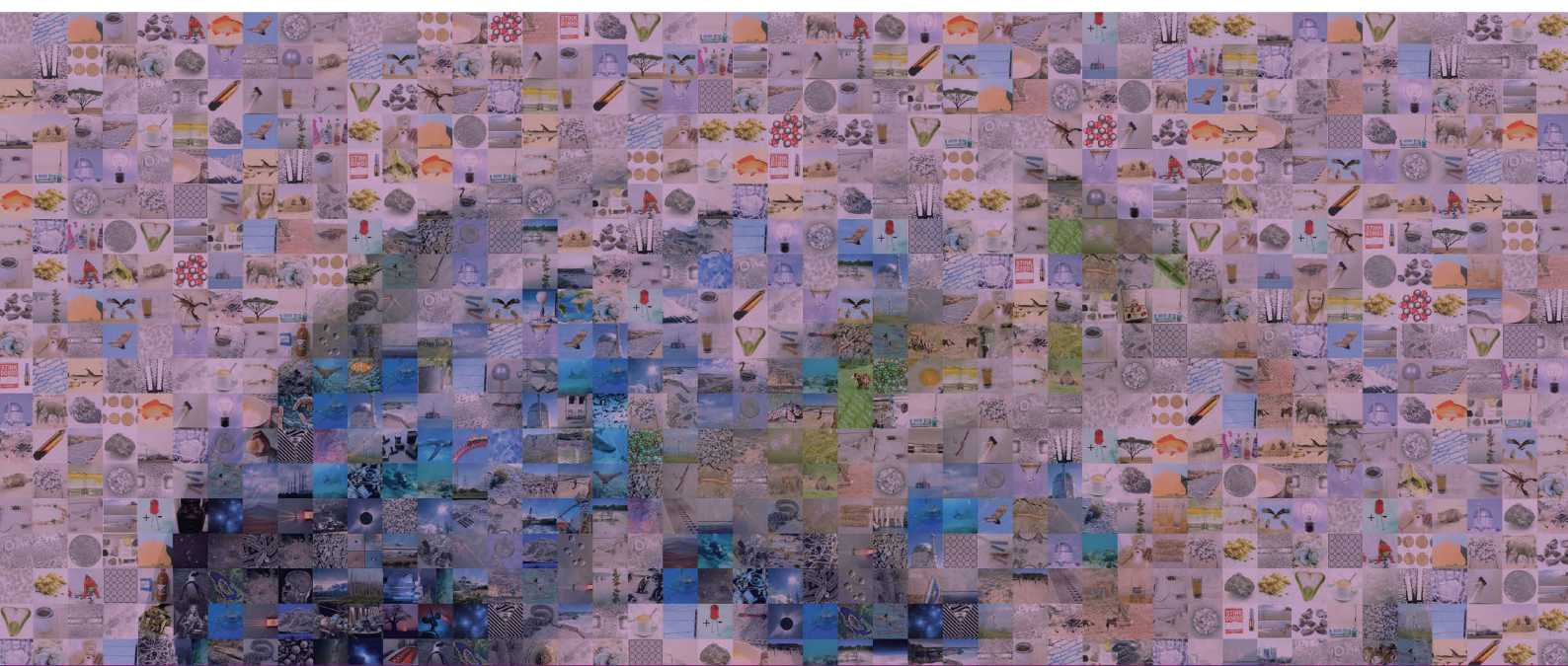
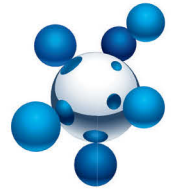

EXPLORE

A World Without Boundaries



basic education

Department:
Basic Education
REPUBLIC OF SOUTH AFRICA



Periodic Table of the Elements

		18																																	
		17																																	
		16																																	
		15																																	
		14																																	
		13																																	
		12																																	
		11																																	
		10																																	
		9																																	
		8																																	
		7																																	
		6																																	
		5																																	
		4																																	
		3																																	
		2																																	
		1																																	
No	Element																																		
1	H																																		
2	He																																		
3	Li	4	Be																																
11	Na	12	Mg																																
19	K	20	Ca	21	Sc	22	Ti	23	V	24	Cr	25	Mn	26	Fe	27	Co	28	Ni	29	Cu	30	Zn	31	Ga	32	Ge	33	As	34	Se	35	Br	36	Kr
37	Rb	38	Sr	39	Y	40	Zr	41	Nb	42	Mo	43	Tc	44	Ru	45	Rh	46	Pd	47	Ag	48	Cd	49	In	50	Sn	51	Sb	52	Te	53	I	54	Xe
55	Cs	56	Ba	57-71	La-Lu	72	Hf	73	Ta	74	W	75	Re	76	Os	77	Ir	78	Pt	79	Au	80	Hg	81	Tl	82	Pb	83	Bi	84	Po	85	At	86	Rn
87	Fr	88	Ra	89-103	Ac-Lr	104	Rf	105	Db	106	Sg	107	Bh	108	Hs	109	Mt	110	Ds	111	Rg	112	Cn	113	Uut	114	Uuq	115	Uup	116	Uuh	117	Uus	118	Uuo
57	La	58	Ce	59	Pr	60	Nd	61	Pm	62	Sm	63	Eu	64	Gd	65	Tb	66	Dy	67	Ho	68	Er	69	Tm	70	Yb	71	Lu						
89	Ac	90	Th	91	Pa	92	U	93	Np	94	Pu	95	Am	96	Cm	97	Bk	98	Cf	99	Es	100	Fm	101	Md	102	No	103	Lr						

- Transition Metal
- Metal
- Metalloid
- Non-metal
- Noble Gas
- Lanthanide
- Actinide



Natural Sciences

Grade 9-B

CAPS

developed by



funded by



Developed and funded as an ongoing project by the Sasol Inzalo Foundation in partnership with Siyavula and volunteers.

Distributed by the Department of Basic Education

COPYRIGHT NOTICE

Your freedom to legally copy this book

You are allowed and encouraged to freely copy this book. You can photocopy, print and distribute it as often as you like. You can download it onto your mobile phone, iPad, PC or flashdrive. You can burn it to CD, email it around or upload it to your website.

The only restriction is that you cannot change *this version* of this book, its cover or content in any way.

For more information about the *Creative Commons Attribution-NoDerivs 3.0 Unported (CC-BY-ND 3.0) license*, visit:

<http://creativecommons.org/licenses/by-nd/3.0/>



This book is an **open educational resource** and you are encouraged to take full advantage of this.



Therefore, if you would like a version of this book that you can **reuse, revise, remix** and **redistribute**, under the *Creative Commons Attribution 3.0 Unported (CC-BY) license*, visit our website, www.curious.org.za

AUTHORS' LIST

This book was written by Siyavula with the help, insight and collaboration of volunteer educators, academics, students and a diverse group of contributors. Siyavula believes in the power of community and collaboration by working with volunteers and networking across the country, enabled through our use of technology and online tools. The vision is to create and use open educational resources to transform the way we teach and learn, especially in South Africa.

Siyavula Coordinator and Editor

Megan Beckett

Siyavula Team

Ewald Zietsman, Bridget Nash, Melanie Hay, Delita Otto, Marthélize Tredoux, Luke Kannemeyer, Dr Mark Horner, Neels van der Westhuizen

Contributors

Dr Karen Wallace, Dr Nicola Loaring, Isabel Tarling, Sarah Niss, René Toerien, Rose Thomas, Novosti Buta, Dr Bernard Heyns, Dr Colleen Henning, Dr Sarah Blyth, Dr Thalassa Matthews, Brandt Botes, Daniël du Plessis, Johann Myburgh, Brice Reignier, Marvin Reimer, Corene Myburgh, Dr Maritha le Roux, Dr Francois Toerien, Martli Greyvenstein, Elsabe Kruger, Elizabeth Barnard, Irma van der Vyver, Nonna Weideman, Annatjie Linnenkamp, Hendrine Krieg, Liz Smit, Evelyn Visage, Laetitia Bedeker, Wetsie Visser, Rhoda van Schalkwyk, Suzanne Grové, Peter Moodie, Dr Sahal Yacoob, Siyalo Qanya, Sam Faso, Miriam Makhene, Kabelo Maletsoa, Lesego Matshane, Nokuthula Mpanza, Brenda Samuel, MTV Selogiloe, Boitumelo Sihlangu, Mbuzeli Tyawana, Dr Sello Rapule, Andrea Motto, Dr Rufus Wesi

Volunteers

Iesrafeel Abbas, Shireen Amien, Bianca Amos Brown, Dr Eric Banda, Dr Christopher Barnett, Prof Ilsa Basson, Mariaan Bester, Jennifer de Beyer, Mark Carolissen, Tarisai Chanetsa, Ashley Chetty, Lizzy Chivaka, Mari Clark, Dr Marna S Costanzo, Dr Andrew Craig, Dawn Crawford, Rosemary Dally, Ann Donald, Dr Philip Fourie, Shamin Garib, Sanette Gildenhuys, Natelie Gower-Winter, Isabel Grinwis, Kirsten Hay, Pierre van Heerden, Dr Fritha Hennessy, Dr Colleen Henning, Grant Hillebrand, Beryl Hook, Cameron Hutchison, Mike Kendrick, Paul Kennedy, Dr Setshaba David Khanye, Melissa Kistner, James Klatzow, Andrea Koch, Grove Koch, Paul van Koersveld, Dr Kevin Lobb, Dr Erica Makings, Adriana Marais, Dowelani Mashuvhamele, Modisaemang Molusi, Glen Morris, Talitha Mostert, Christopher Muller, Norman Muvoti, Vernusha Naidoo, Dr Hlumani Ndlovu, Godwell Nhema, Edison Nyamayaro, Nkululeko Nyangiwe, Tony Nzundu, Alison Page, Firoza Patel, Koebraa Peters, Seth Phatoli, Swasthi Pillay, Siyalo Qanya, Tshimangadzo Rakhuhu, Bharati Ratanjee, Robert Reddick, Adam Reynolds, Matthew Ridgway, William Robinson, Dr Marian Ross, Lelani Roux, Nicola Scriven, Dr Ryman Shoko, Natalie Smith, Antonette Tonkie, Alida Venter, Christie Viljoen, Daan Visage, Evelyn Visage, Dr Sahal Yacoob

A special thanks goes to St John's College in Johannesburg for hosting the first planning workshop for these workbooks and to Pinelands High School in Cape Town for the use of their school grounds for photography.

To learn more about the project and the Sasol Inzalo Foundation, visit the website at:

www.sasolinzalofoundation.org.za

Table of Contents

Teacher's Guide Overview	12
Teacher's Guide Overview	12
Curious? Discover the possibilities!	12
The Natural Sciences curriculum	13
How to use this workbook	16
Get involved	3
Energy and Change	4
1 Forces	6
1.1 Types of forces	8
1.2 Contact forces	20
1.3 Field (non-contact) forces	31
2 Electric cells as energy systems	72
2.1 Electric cells	73
3 Resistance	84
3.1 What is resistance?	86
3.2 Uses of resistors	88
3.3 Factors that affect resistors	96
4 Series and parallel circuits	112
4.1 Series circuits	114
4.2 Parallel circuits	130
5 Safety with electricity	154
5.1 Safety practices	155
5.2 Illegal connections	168
6 Energy and the national electricity grid	176
6.1 Electricity generation	178
6.2 Nuclear power in South Africa	186
6.3 National electricity grid	191
7 Cost of electrical energy	200
7.1 What is electrical power?	201
7.2 The cost of energy consumption	205
Planet Earth and Beyond	225
1 The Earth as a system	228
1.1 Spheres of the Earth	229
2 The lithosphere	246
2.1 What is the lithosphere?	247
2.2 The rock cycle	255

3 Mining of mineral resources	278
3.1 Exploration: Finding minerals	282
3.2 Extracting ores	284
3.3 Crushing and milling	289
3.4 Separating minerals from waste	291
3.5 Refining minerals	297
3.6 Mining in South Africa	300
4 The atmosphere	314
4.1 What is the atmosphere?	316
4.2 The troposphere	321
4.3 The stratosphere	325
4.4 The mesosphere	328
4.5 The thermosphere	329
4.6 The greenhouse effect	334
5 Birth, life and death of a star	352
5.1 The birth of a star	353
5.2 Life of a star	358
5.3 Death of a star	363
A Assessment rubrics	382
A.1 Assessment Rubric 1: Practical activity	383
A.2 Assessment Rubric 2: Investigation	384
A.3 Assessment Rubric 3: Graph	385
A.4 Assessment Rubric 4: Table	386
A.5 Assessment Rubric 5: Scientific drawing	387
A.6 Assessment Rubric 6: Research assignment or Project	388
A.7 Assessment Rubric 7: Model	389
A.8 Assessment Rubric 8: Poster	390
A.9 Assessment Rubric 9: Oral presentation	391
A.10 Assessment Rubric 10: Group work	392
Image Attribution	394

Teacher's Guide Overview

Curious? Discover the possibilities!

VISIT

Carl Sagan was an astronomer, astrophysicist, cosmologist, author, science popularizer and science communicator. Watch one of his most pertinent messages for humanity here bit.ly/1bbVDqg

Asking questions and discovering our world around us has been central to human nature throughout our history. Over time, this search to understand our natural and physical world through observation, testing and refining ideas, has evolved into what we loosely think of as 'science' today. Key to this, is that science is a continuous revision in progress, it is a mechanism rather than a product, it is a way of thinking rather than a collection of knowledge, whose driving force is not certainty in a truth, but rather being comfortable with uncertainty, thereby cultivating curiosity.

However, as Carl Sagan famously said in 1994:

"We live in a society absolutely dependent on science and technology, and yet have cleverly arranged things so that almost no one understands science and technology. That's a clear prescription for disaster."

We need to replace fear of the unknown and the difficult with curiosity, as Marie Curie said:

"Nothing in life is to be feared, it is only to be understood. Now is the time to understand more, so that we may fear less."

We would like to instill this sense of curiosity and an enquiring mind in learners. Science, technology, engineering and mathematics are not subjects to be feared, rather they are tools to unlock the potential of the world around you, to create solutions to problems, to discover the possibilities.

But, how do we practically do this in our classrooms? We would like this workbook to become a tool that you can use to do this. The theme for the presentation of this content in Gr 7-9 Natural Sciences is 'Curious? Discover the possibilities.' We have shown everyday science and objects with 'doodles' over them to show how if you are curious, intrigued and investigate the world around you, there are many possibilities for discovery. Sometimes these doodles are science or technology related, and sometimes they are more fantastical and fun. Learners should be inspired to discover, but also imagine the possibilities, as Freeman Dysan said:

"The glory of science is to imagine more than we can prove."

Learners must be encouraged to 'doodle' themselves, take notes during your class discussions, write down their observations, reflect on what they have learned. They must not be afraid of drawing and writing in these books. Science is also about being creative in your thinking.

We have aimed to present the content in an investigative, questioning way. At the beginning of each chapter, the topics are introduced by asking questions to which you will discover the answers as you go through the chapter. In teaching learners to ask questions, make observations, think freely and creatively, they



DID YOU KNOW?

Marie Curie was a chemist and physicist famous for becoming the first person to be awarded two Nobel Prizes.

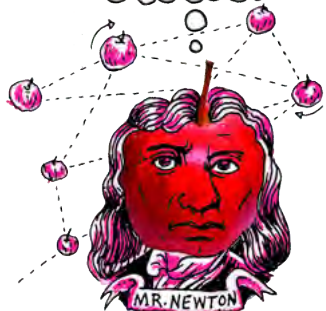

will be rewarded. Although, possibly not every time - it requires patience and determination. Although your learners will be exploring science and the world around us within a classroom context where assessment is integral, keep in mind this idea from Claude Levi-Strauss, when instilling the ethos of science in your learners:

"The scientist is not a person who gives the right answers, but one who asks the right questions."

Science is relevant to everyone. Scientific principles, knowledge and skills can be applied in creative and exciting ways to solve problems and advance our world. It is not just a subject restricted to our classrooms, but reaches far beyond, and within. Ultimately, we also want learners to embark on a personal discovery and be curious about their own potential and possibilities for the future.

Albert Einstein certainly did this when he observed:

"The most beautiful experience we can have is the mysterious - the fundamental emotion which stands at the cradle of true art and true science."

TAKE NOTE

Albert Einstein repeatedly did poorly at school, dropped out at 16 and failed his first university entrance examinations. Every child deserves a chance to become someone, sometime in some place.



The Natural Sciences curriculum

As learners enter the Senior Phase in their schooling, the focus is now purely on Natural Sciences within this subject, and Technology is a separate subject. However, there are close links between the content in both of these subjects as they complement each other. The Natural Sciences curriculum also links to what learners cover in Social Sciences and Life Orientation. Whether you are a subject specialist teacher, or a class teacher, it is worthwhile to take note of where Natural Sciences overlaps with and integrates with some of the other subjects that learners are covering.

Organisation of the curriculum

In the Natural Sciences curriculum, the knowledge strands below are used as a tool for organising and grouping the content.

Natural Sciences Knowledge Strands
Life and Living
Matter and Materials
Energy and Change
Planet Earth and Beyond

These knowledge strands follow on from Gr 4-6. The strands also link into each other, and these have been pointed out both within the learners' workbook and here in the teachers guide.

We have also produced **concept maps** which show the progression of concepts across the grades, within a strand, and how they build upon each other. These concept maps are useful tools for teaching to see what learners should have covered in previous grades, and where they are going in the future.

VISIT

If you would like to see what learners covered in **Gr 4-6 with the Thunderbolt Kids**, visit www.thunderboltkids.co.za



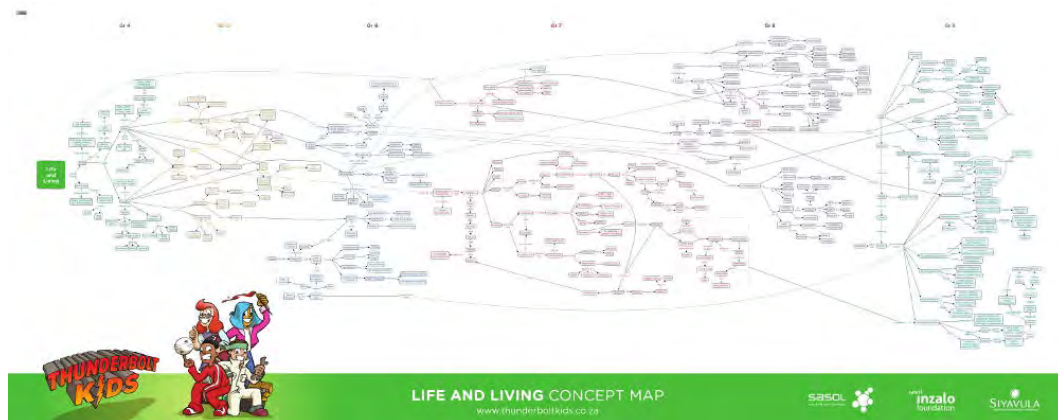

Allocation of teaching time

The time allocation for Natural Sciences is as follows:

- 10 weeks per term with 3 hours per week
- Grades 7, 8 and 9 have been designed to be completed within 34 weeks
- Terms 1 and 3's work will cover 9 weeks each with 3 hours (1 week) allocated to assessment within each of these terms
- Terms 2 and 4's work will cover 8 weeks each, with 2 weeks allocated to revision and examinations at the end of each of these terms

Below is a summary of the time allocations per topic in Grade 9. This time allocation is a guideline for how how many weeks should be spent on each topic (chapter).

Life and Living



Chapter	Time allocation
1. Cells as the basic units of life	2 weeks
2. Systems in the human body	2 weeks
3. Human reproduction	2 weeks
4. Circulatory and respiratory systems	1.5 weeks
5. Digestive system	1.5 weeks

Matter and Materials

Chapter	Time allocation
1. Compounds	1 week
2. Chemical reactions	1 week
3. Reactions of metals with oxygen	1.5 weeks
4. Reactions of non-metals with oxygen	1 week
5. Acids, bases and pH value	1 week
6. Reactions of acids with bases	2 weeks
7. Reactions of acids with metals	0.5 weeks

Energy and Change

Chapter	Time allocation
1. Forces	2 weeks
2. Electric cells as energy systems	0.5 weeks
3. Resistance	1 week
4. Series and parallel circuits	2 weeks

5. Safety with electricity	0.5 weeks
6. Energy and the national electricity grid	1 week
7. Cost of electrical power	2 weeks

Planet Earth and Beyond

Chapter	Time allocation
1. The Earth as a system	1 week
2. Lithosphere	2 weeks
3. Mining of mineral resources	2 weeks
4. Atmosphere	2 weeks
5. Birth, life and death of stars	1 week

We have provided a finer breakdown of the time into the number of hours to spend on each section within a chapter in the Chapter overviews in the Teacher's Guide. However, again, this is a guideline or suggestion and should be applied flexibly according to circumstances in the classroom and to accommodate the interests of your learners.

Specific aims

There are three specific aims in Natural Sciences which are covered in these workbooks in the range of tasks provided and in the way the content is presented.

Specific Aim 1: 'Doing Science'

Learners should be able to complete investigations, analyse problems and use practical processes and skills in evaluating solutions.

There are many practical tasks within this workbook that provide the opportunity to conduct investigations to answer questions using the scientific method, to use scientific apparatus, instruments and materials and to develop a range of process skills, such as observing, measuring, identifying problems and issues, predicting, hypothesizing, recording, interpreting and communicating information. The skills associated with each task in this workbook have been identified in the chapter overviews in this Teacher's Guide.

Learners also need to be aware of the ethical concerns and values that underpin any science work that they do, as well as health and safety precautions. Where appropriate, these have been pointed out in the learners workbook and in this Teacher's Guide.

Specific Aim 2: 'Knowing the subject content and making connections'

Learners should have a grasp of scientific, technological and environmental knowledge to be able to apply it in new contexts.

In teaching and discovering the content in Natural Sciences, the aim for learners is not to just recall facts, but to also use the knowledge to make connections between the ideas and concepts in their minds. Most of the activities in this workbook have questions at the end which aim to consolidate the knowledge and skills learned in the task, and also help learners to make connections with what they have previously learned.

There are many opportunities for discussion when going through the content in these workbooks. This is often highlighted in the Teacher's Guide with suggestions for how to lead the discussion and what questions to ask your

learners to stimulate their minds and create links between what they are learning. There are often questions within the learners' workbooks which relate what they are learning at that point to previously acquired knowledge and experience.

Many of the links between content and also between strands and grades are pointed out within this Teacher's Guide. We suggest also making use of the concept maps when creating a clear picture in your own mind of the framework of knowledge that learners should have up to that point about a particular topic.

Specific Aim 3: 'Understanding the uses of Science'

Learners should understand the uses of Natural Sciences and indigenous knowledge in society and the environment.

There is a strong emphasis in these workbooks to show that science is relevant to our everyday lives, and it is not restricted to what we learn within the classroom. Rather, we are learning about the natural and physical world around us and how it works, as well as how our own bodies function.

These workbooks aim to show learners that many of the issues in our world can be solved through scientific discovery and pursuit. For example, improving water quality, conserving our environment, finding renewable energy sources and medical research into cures for diseases. Where appropriate, the history of various scientific discoveries and inventions, as well as the scientists involved, have been discussed.

These workbooks also aim to highlight the beauty, diversity and scientific achievements, discoveries and possibilities in our country, South Africa. An appreciation of local indigenous knowledge is very important. When going through particular topics in class, encourage your learners to talk about their own experiences so that learners are exposed to the indigenous knowledge of different cultures, to different belief systems and worldviews.

Understanding how scientific discovery has shaped and influenced local and global communities will enable learners to see the connections between Science and Society. This will help to reinforce that Science is practical and relevant, and it can be used as a tool together with other subjects like Mathematics and Technology to find solutions and understand our world.

VISIT
Learn more about Creative Commons licenses and all the freedoms that these licenses grant you!
bit.ly/1cesNJT



How to use this workbook

We would like these Curious workbooks and Teacher's Guides to become a tool for you in your classrooms to teach, explore and discover Natural Sciences.

But first, did you notice the copyright license at the front of this book? At Siyavula, our textbooks and workbooks are published under an **open** copyright license.

An OPEN license?

An open license is fundamentally different to the traditional closed copyright licenses. Instead of imposing restrictions on how you can use this content (for example, all rights reserved), this open license grants you freedoms! The Siyavula books are published under a Creative Commons license.

You are legally allowed to copy this book.

We encourage you to photocopy it, download it from our website, save it on your mobile phone, tablet, PC or flashdrive, print it and distribute it as often as you like.

But, how does that help? This is part of a larger, global movement called **open education**. These books are an example of an **open educational resource** (OER). OERs are generally defined as freely accessible, usually openly licensed documents and online resources that can be used in teaching, learning, education, assessment and research. Open education aims to break the barriers that many people face when wanting to get an education, namely that content, courses and resources are hidden behind restricting closed copyright licences and are expensive.

By using this book, you are also part of the global open education movement, striving to make education as accessible as possible by breaking down the barriers that learners, student, teachers, academics and the general public normally face.

With OERs, you are free to:

- **Reuse** - the right to reuse the content in its unaltered form
- **Revise** - the right to adapt, adjust, modify, or alter the content itself (for example if you want to modify an activity to suit your learners' needs or translate the content into another language)
- **Remix** - the right to combine the original or revised content with other content to create something new (for example if you want to include one of your own activities or content into this existing content)
- **Redistribute** - the right to share copies of the original content, your revisions, or your remixes with others (for example if you want to give a copy to a friend, a fellow teacher or share what you have done with your cluster of schools)

We encourage you to modify and tweak this content to suit your learners and your context. You just need to attribute Siyavula, as is specified in the Creative Commons license.

You can download a soft copy of the source files for these books from our website: www.curious.org.za

We would also love it if you told us how you are using this content as it helps us refine our processes.

Structure of the book

There is an A and a B book for the Natural Sciences content.

The A book covers term 1 and 2:

- Life and Living
- Matter and Materials

The B book covers terms 3 and 4:

- Energy and Change
- Planet Earth and Beyond

These books are an amalgamation between workbooks and textbooks. They have spaces for learners to write and draw whilst completing their tasks. Learners must be encouraged to write in these books, take notes, and make them their own. These workbooks also contain the content to support the various tasks. This makes these books slightly longer than usual.

The beginning of each chapter starts off with **KEY QUESTIONS**. These introduce the content that will be covered in the chapter, but rather phrased as questions. This reinforces the idea of questioning, being curious and the investigative nature of science to discover the world around us and how it works.



TAKE NOTE

A suggestion is to use the concept maps as a self-study homework exercise for learners to go over what they have learned in the chapter.



The content and various **ACTIVITIES** and **INVESTIGATIONS** follow:

- **Investigations** are those tasks where learners will be using the scientific method to answer a question, test a hypothesis, etc. These are science experiments.
- **Activities** are all other tasks where the learner is required to do something whether it is making a model, researching a topic, discussing an idea, doing calculations, filling in a table, doing a play, writing a poem, etc.

At the end of each chapter there is a **SUMMARY**, where the **KEY CONCEPTS** highlight the main points from the chapter. Following this, there is a **CONCEPT MAP** for each chapter. One of the aims for these workbooks is to also teach various methods of studying and taking notes. Producing concept maps is one way to consolidate information. Throughout the year, the skill of making concept maps will be taught as the maps have more and more for the learners to fill in themselves as the year progresses.

Lastly, there is **REVISION** at the end of each chapter. There are mark allocations for these questions. These revision exercises can be used as formal or informal assessment.

At the end of each strand there is a **GLOSSARY** which contains the definitions for all the **NEW WORDS** which are highlighted throughout that strand.

Going through the content

These workbooks are a tool for you to use in your classroom and to assist you in your teaching. You will still need to plan your lessons and decide which activities you would like to do. There are sometimes more activities provided than what is possible within the time allocation. We have specifically done this to give teachers a choice, providing different levels of tasks.

The tasks which are suggested in CAPS have been identified here in the teachers guide, and we have marked those that are **optional** or **extensions**.

When going through the content in class and you are using the workbook, there are various questions within the content. These questions are aimed at stimulating class discussions where learners can take notes, or they link back to what learners have already done. The answers are provided in the Teacher's Guide. Use these questions to check learners understanding and keep engaged with the content.

The various activities and investigations often contain questions at the end. The questions can often be used as a separate activity, even the next day in class or as homework, to reinforce what was learned.

Teacher's notes

The way this Teacher's Guide is structured to provide the content of the learner's book, but with all the model solutions written in italic blue text, and with many **Teacher's notes** embedded within the content.

An example of a teacher's note:

TEACHER'S NOTE

This is an example of what a teacher's note looks like. It can contain:

- chapter overviews
- suggestions on how to introduce a topic

- guidelines for setting up or demonstrating a practical task
- general tips for teaching the content
- extra background information on a topic
- misconceptions which can easily be introduced to learners, or which learners might already have

At the beginning of each chapter, there is a **CHAPTER OVERVIEW**. This is crucial for your planning. This overview contains:

- the number of weeks allocated to the chapter, as suggested in CAPS
- an introduction to the chapter, highlighting any links to previous content that learners have already covered, or anything to be aware of when going through the content
- tables highlighting the various tasks for the chapter

The tables for each section can be used to plan your lessons. We have suggested an **hours break down** to spend on each section within the chapter, based on how much content there is to cover, and the number of tasks. This is only a suggested guideline.

Within each table, we have listed the different Activities and Investigations and the **process skills** associated with each task.

The third column contains the Recommendation for the task. These recommendations are, in order of priority:

- **CAPS suggested** (a task suggested in CAPS)
- **Suggested** (a task we suggest doing, but is not suggested in CAPS)
- **Optional** (an additional activity which is optional if you have time or would rather do this than the other suggested tasks)
- **Extension** (an additional activity which is optional and also an extension)

An example of one of these tables is given below:

1.1 Cell structure (2.5 hours)

Tasks	Skills	Recommendation
Activity: Brainstorm the Seven Functions of Life	Recalling information	Optional (Revision)
Activity: Summarise what you have learnt	Recalling information, identifying, writing	Suggested
Activity: Cell 3D model	Planning, identifying, describing	CAPS suggested

You will need to look at how many hours you have for each section, and then decide which tasks you would like to do with your learners. These tables provide a useful overview and will also help you choose tasks so that you cover a range of process skills and specific aims.

Assessment

The assessment guidelines for Gr 7-9 Natural Sciences are outlined in CAPS on page 85.

There are many opportunities for informal assessment within these workbooks. Any of the tasks can be chosen to continuously monitor your learners' progress as well as checking the short answers they provide to questions interspersed in the content.

At the end of each strand in the CAPS document, there is a section on assessment guidelines. There is a column entitled 'Check the learner's knowledge and that they can:' and there is a list. These items are included within the content for that strand and can be used for assessment.

The questions in the revision exercises at the end of each term can be used as formal assessment and you can use these questions, as well as your own, to make class tests and examinations.

At the end of the Teacher's Guide, there is an appendix with Assessment Rubrics. These rubrics are a guideline for assessment for the different tasks which you would like to assess, either informally (to assess learners' progress) or formally (to record marks to contribute to the final year mark).

The various rubrics provided are:

- Assessment Rubric 1: Practical activity
- Assessment Rubric 2: Investigation
- Assessment Rubric 3: Graph
- Assessment Rubric 4: Table
- Assessment Rubric 5: Scientific drawing
- Assessment Rubric 6: Research assignment or project
- Assessment Rubric 7: Model
- Assessment Rubric 8: Poster
- Assessment Rubric 9: Oral presentation
- Assessment Rubric 10: Group work

Margin boxes

You may have already noticed some of the margin boxes in this Teacher's Guide overview so far. These boxes contain additional information and enrichment.

The **NEW WORDS** highlight not only the new words used, but also the key words for the chapter or section. The definitions for all these new words are listed in the glossary at the back of the strand.

DID YOU KNOW has some fun, interesting facts relating to the content.

TAKE NOTE points out useful tips, with a special focus on language usage and the origins of words. This may be useful to second language learners.

The **VISIT** boxes contain links to interesting websites, videos relating to the content or simulations. This enrichment is also aimed to encourage learners to be curious about their subject in their own time by discovering more online. We feel it is important for learners to be aware that science is a rapidly advancing field and there are many exciting, innovative and useful discoveries being made all the time in science, mathematics and technology research.

To access the links in the VISIT boxes, you will see there is a bit.ly link. This is a shortened link that we created, as sometimes the website links to Youtube videos can be very long! You simply need to type this whole link into the address bar in your internet browser, either on your PC, tablet or mobile phone, and it will direct you to the website or video.

For example, in this Teacher's Guide overview, there is the link to a video about why open education matters. It is bit.ly/17yW5Lj Simply type this into your address bar as shown below and press enter.



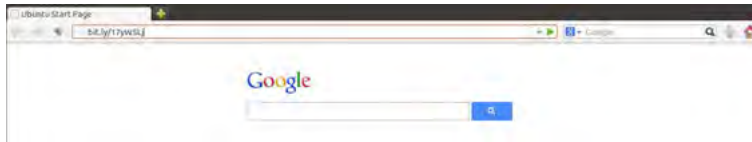

This will either direct you to a website page, or to our website where you can watch the video online.

Discover more online at www.curious.org.za

Get involved

When we first embarked on this journey to create these books, our first step was to hold a workshop with volunteer teachers to get their perspective, suggestions and experience. Just turn to the front cover of this book to see how many people contributed in some way to these books! At Siyavula, we believe in openness and transparency and we would love your input in the next phase.

These books are not perfect and we will be continuously improving them. We would find your input and experience as a teacher crucial and highly beneficial in this process.

- Do you have any feedback about the books?
- Do you have suggestions?
- Would you like to share how you use these books in your classroom?
- Have you found any errors you would like to point out so we can fix them?
- Have you tried an activity and found a better way of doing it?
- What more would you like to see in these workbooks?

Get involved and let us know!



Find out more about our Siyavula Community at projects.siyavula.com/community

And sign up by following this link bit.ly/15eiA6u. Specify Gr 7-9 Natural Sciences to stay informed about this process going forward in the future.

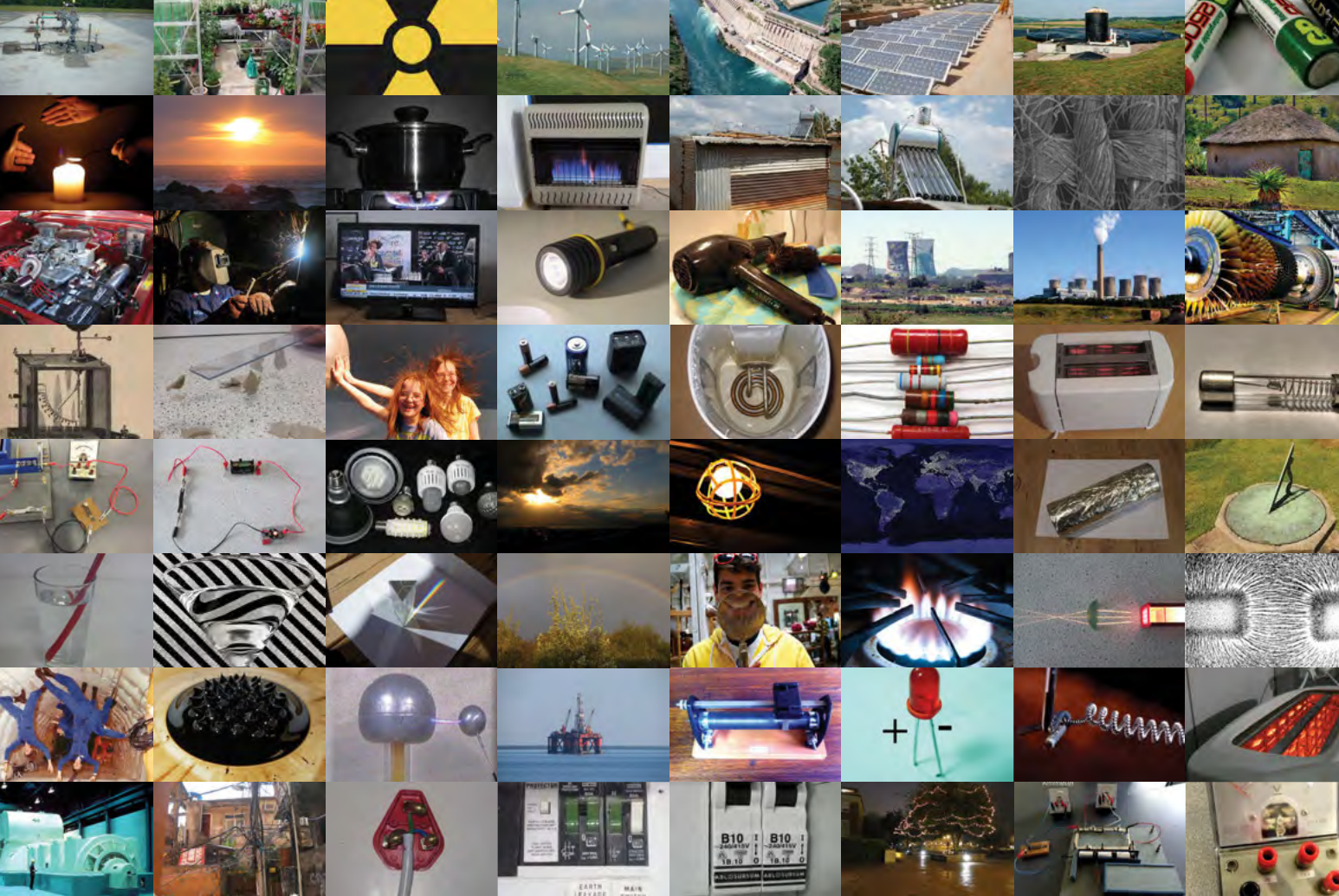

ENERGY AND CHANGE



DOWNLOAD MORE RESOURCES LIKE THIS ON [ECOLEBOOKS.COM](http://ecolebooks.com)

1 Forces

TEACHER'S NOTE

Chapter overview

2 weeks

This chapter introduces learners to the concept of a force. Learners would have been exposed to some of the concepts around forces in previous grades, for example:

- Gr. 8 **Static electricity** introduced learners to friction and electrostatic force; and
- Gr. 8 **Energy transfer in electrical systems** introduced learners to the attraction and repulsion forces between magnets when looking at the magnetic effect of an electric current.

Learners will discover that there are two main categories of forces, namely contact and non-contact forces. They will be introduced to the concept of force fields. This chapter has many opportunities for getting the learners to engage physically with the concepts. Have learners pull and push objects and move each other around the classroom or outside in the school grounds. Have them push against buildings to experience the resistance offered by surfaces. Allow them to walk on different surfaces and feel the effects of friction.

There are many tasks included in this chapter. You might not have time to cover all of them. Some are extension tasks and some tasks are revision from Gr. 7 and 8. You will need to assess the requirements and capabilities of your class in order to decide which tasks to perform. There is a lot of content to cover in this chapter and many concepts form the foundation for what learners will cover in Physical Sciences in Gr. 10-12. You might need to spend more than the allocated 2 weeks of time that is specified in CAPS. Some of the other chapters in this term might not require as much time.

1.1 Types of forces (1.5 hours)

Tasks	Skills	Recommendation
Activity: What can forces do?	Group work, following instructions, doing and observing	CAPS suggested
Activity: Is it a push or a pull?	Accessing and recalling, identifying, sorting and classifying, describing, explaining	Suggested
Activity: Pairs of forces	Group work, interpreting (scenarios and images) describing, explaining	CAPS suggested
Activity: Can forces act over a distance?	Demonstrating, observing, describing, explaining	Optional

Additional/alternative task:

- Activity: Tug of war - Optional extension making use of PhET simulations.

1.2 Contact forces (1 hour)

Tasks	Skills	Recommendation
Investigation: What is the relationship between the normal force and friction?	Carrying out investigation, observing, recording, analysing, interpreting, drawing conclusion	Suggested (extension)

Additional/alternative task:

- Activity: Friction - Optional extension making use of PhET simulations.

1.3 Field forces (3.5 hours)

Tasks	Skills	Recommendation
Investigation: Dropping objects	Group work, predicting, hypothesising, carrying out investigation, observing, recording, comparing, interpreting, drawing conclusion	CAPS suggested
Investigation: What is the relationship between the mass of an object and its weight?	Hypothesising, measuring, recording, drawing graph, interpreting, calculating, drawing conclusion	Suggested
Activity: Weight and mass calculations	Calculating	CAPS suggested
Activity: How much would you weigh on other planets?	Measuring, calculating, interpreting information in table	Optional/additional
Investigation: Magnetic or non-magnetic materials	Hypothesising, observing, recording, drawing conclusion	CAPS suggested
Activity: Can a magnetic force act through substances?	Carrying out activity, observing, recording, describing, explaining	CAPS suggested
Activity: Visualising magnetic fields	Carrying out activity, observing, recording, drawing representations, communicating (graphically) describing, explaining	CAPS suggested

Activity: Charging objects	Group work, following instructions, observing, describing, explaining,	CAPS suggested
Activity: Turning the wheel	Observing, describing	CAPS suggested
Activity: Van de Graaff generator	Observing, describing	Optional extension



Did you know that these workbooks were created at Siyavula with the input from many contributors and volunteers? Just turn to the front to see the long list! Read more about Siyavula at our website: www.siyavula.com . You can also sign up at our community page if you would like to stay in touch and get involved in our projects.

Siyavula has also created a **range of textbooks** for other grades and subjects, and we are going to be producing more. These textbooks and workbooks are **openly-licensed and freely available** for you to use, download, copy, rework and redistribute. The Siyavula textbooks that are currently available are:

- Gr. 4-6 Natural Sciences and Technology:
www.thunderboltkids.co.za
- Physical Sciences Gr. 10-12:
www.everythingscience.co.za
- Mathematics Gr. 10-12, Mathematical Literacy Gr. 10:
www.everythingmaths.co.za



KEY QUESTIONS:

- What is a force?
- What effect can a force have on an object?
- Do forces have to be between objects which are touching?

1.1 Types of forces

What is a force?

Think of the following situation: You are all helping your teacher to rearrange the classroom and she asks you to move her desk from one side of the classroom to the other. How would you do that? The desk is too heavy for you to lift, so how do you get it across the classroom?

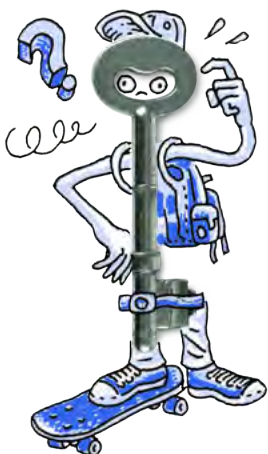

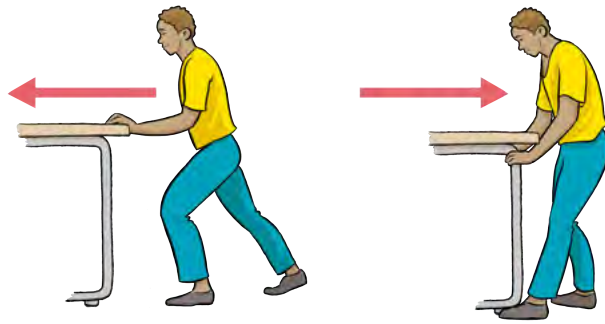

That is right, you are going to either push it or pull it across the room. In doing so, you have exerted a force on the desk to get it to move.

TEACHER'S NOTE

Have you noticed that one of the **Did you know** margin boxes in these workbooks contains a drawing of Newton?



Sir Isaac Newton (25 December 1642 - 20 March 1727).

A force is a push or a pull on an object. The unit in which we measure force is a **newton (N)**.

The newton is named after Sir Isaac Newton, an English physicist and mathematician. Sir Isaac Newton is recognised as one of the most influential scientists of all times. The unit of force is named after him in recognition of his work in mechanics and his three laws of motion.

We use forces every day of our lives. Our own bodies rely on forces. Our muscles pull on our bones to allow us to move. Our feet push on the ground when we walk. To open doors, to pick up our food - everything we do involves some kind of force.

What can forces do? Let's experiment with forces and see what we can do.

ACTIVITY: What can forces do?

This activity is all about experimenting with different objects and seeing what happens to them when we push and pull them. Learners should see that pushing on solid objects accelerates them. Pushing or pulling on sponges, balloons and play dough distorts their shape and the ball can be made to move. Each group will need the materials listed below.



MATERIALS:

- blocks (wooden or metal)
- sponge or piece of foam
- ball
- blown up balloon
- putty or play dough

INSTRUCTIONS:

1. Work in groups of 2 or 3 as you follow the instructions and describe the effects of the forces that you are applying.
2. Start with the ball and place it on the ground. Push it towards your partner. What were you able to cause the ball to do by pushing it?
Learners are able to cause the ball to move.
3. When one of you pushes the ball to the other, the third person must give the ball another push at an angle to the direction in which it is already moving. What were you able to do to the direction in which the ball was moving?
Pushing the ball changes its direction as it is moving.
4. Exert a force in the opposite direction to its movement while it is already moving. What are you able to cause the ball to do?
Learners are able to slow the ball down or stop it.
5. Exert a force in the same direction to its movement while it is already moving. What are you able to cause the ball to do?
Learners are able to make the ball move faster.
6. Pick up the piece of putty or play dough. Exert pulling or pushing forces on it. Try this out with the blown up balloon too. What are you doing to the shape of the putty or play dough and the blown up balloon?
Exerting forces on the putty or playdough changes its shape and it remains deformed. Exerting forces on the balloon also changes its shape, but it resumes its shape again once you stop exerting a force on it.
7. Push and pull the wooden blocks. Are you able to change their motion? Are you able to change their shape?
Yes, you can change their motion by causing them to move. No, you are not able to change the shape.
8. Pick up the piece of sponge and twist it. This is also a type of force which changes the sponge's shape.
9. Press the sponge between both hands. This is called compression.

Effects of forces

From the last activity, you should have seen that forces can have the following effects:

- Forces can change the **shape** of an object. This is called deformation.
- Forces can change the **motion** of an object. If an object is stationary, a force can cause the object to start moving. Or, if an object is already moving, a force can cause an object to speed up or slow down.
- Forces can change the **direction** in which an object is moving.

How do we describe the motion of an object? When an object is moving, we say it has a **velocity**. Velocity is the rate of change of the position of an object. Velocity is the speed of an object and the direction in which it is moving. Speed describes only how fast an object is moving, whereas velocity gives both how fast and in what direction the object is moving.

An object can move at constant velocity. This means it travels at the same speed in the same direction. For example a car travelling along the highway at 100 km/h in a straight line has a constant velocity. However, what happens when the car moves faster or slows down?

We saw in the last activity that we could change the motion of an object by applying a force to make it speed up or slow down. The velocity of the object is changing over time due to a force acting on it. This is called **acceleration**. Acceleration is the rate of change of a body's velocity with time. In other words, it is a measure of how an object's speed changes every second.

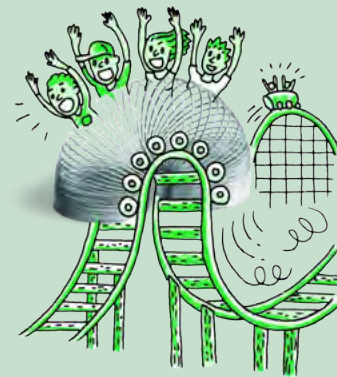

ACTIVITY: Is it a push or a pull?



INSTRUCTIONS:

1. Look at the pictures in the table.
2. Describe the action in each image.
3. Decide if the force being exerted is a push or a pull.
4. Describe the effect of the force.

TEACHER'S NOTE

Action	Push or pull?	Effect
 <p>Kicking a ball.</p>	Push	Kicking the ball causes the direction and speed of the ball to change.

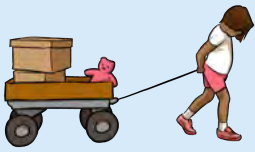
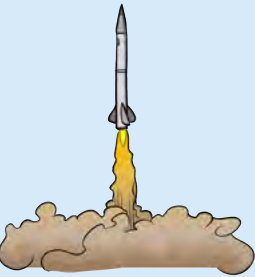
TEACHER'S NOTE

Action	Push or pull?	Effect
 <p>Moulding clay.</p>	<p>Push</p>	<p>The push exerted on the clay changes the shape of the clay.</p>
 <p>Playing with a toy wagon.</p>	<p>Pull</p>	<p>Pulling changes the motion of the wagon.</p>
 <p>A rocket blasting off into space.</p>	<p>Push</p>	<p>Pushing force changes the motion of the rocket (i.e. accelerating it)</p>
 <p>Exercising on a bar.</p>	<p>Pull</p>	<p>Pulling upwards changes the motion of the boy's body.</p>

QUESTIONS:

TEACHER'S NOTE

These questions on identifying the object experiencing the force and the agent causing the force are conceptually important when applying Newton's laws in later grades.

1. In the example of the girl kicking the ball, which is the object experiencing the force and which is the agent of the force (i.e. the body which is applying the force)?
The soccer ball is experiencing the force and the girl's foot is the agent applying the force.
2. When moulding clay, which object is experiencing the force and which object is the agent?
The clay is experiencing the force and the hands are the agent.

Pairs of forces

We are now going to do another practical activity to investigate another concept about forces.

ACTIVITY: Pairs of forces

INSTRUCTIONS:

1. Work in groups of three for this activity.
First, go up to your classroom wall and push against it. Describe what you feel below.
Learner-dependent answer. Learners may note that they feel the wall pushing back on their hands.
2. When you push on the wall, do you think the wall is pushing back on your hands? How does this force compare to the force you are exerting on the wall?
Yes, it is pushing back.
The force experienced by the learners is equal in magnitude and opposite in direction, which will be discussed later.
3. Stand in a triangle with your two partners and hold hands. Pull on each others' hands. Do you feel your partners' hands pulling back as you pull?
Yes.
4. Still standing in a triangle, place your palms up against each other and push against each others' hands. Do you feel your partners' hands pushing back as you push?
Yes

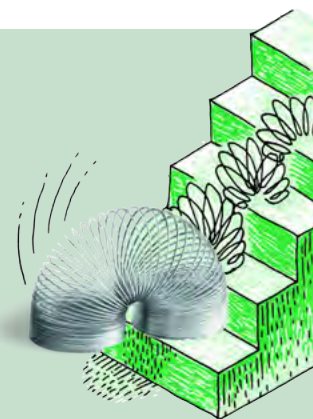

5. Next, stand shoulder-to-shoulder with your two partners. The two learners on the outside must push against the shoulders of the learner in the middle.



6. What happens when you both push with the same force?
The learner in the middle remains stationary.
7. What happens when one of you pushes with a harder force than the other?
The middle learner will move in the direction of the stronger force.
8. Next, the learner in the middle must stretch out his or her arms. The learners on the outside must pull on the middle learner's hands in opposite directions.

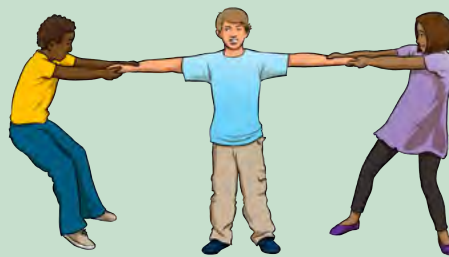

9. What happens when you both pull with equal force?
The middle learner remains stationary.
This is important for later. It is important to identify the forces on a specific object
10. What happens when one of you pulls with a stronger force than the other?
The middle learner will move in the direction of the stronger force.
11. What happens when one of you pulls and the other pushes?
These forces are both acting in the same direction and so the learner moves in the direction of the push and pull.

What we saw in the last activity is that whenever one object exerts a force on a second object, the second object exerts a force back on the first object. You saw this when you pushed against a wall. We say that forces act in pairs. Newton called the one force the **action**, and the other force the **reaction**, as shown in the following diagram.

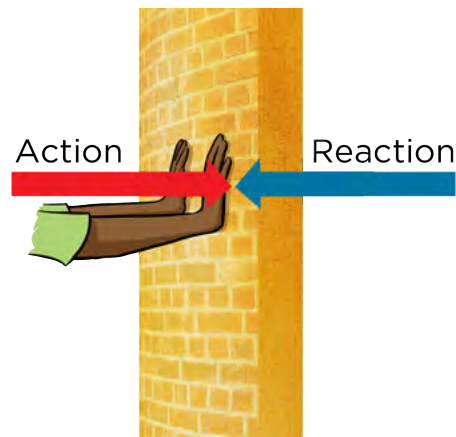

We also saw that when you exerted a force on the wall, you experienced the wall exerting a force back on you. Forces act in pairs on different objects. The force exerted by the second object is **equal in strength** and **opposite in direction** to the first force.

In the last activity, we also saw that more than one force can act on an object at the same time. For example, when two of you were pushing or pulling on your friend in the middle. The effect of the different forces acting together depends on how big each force is and what direction each force is acting in. When two or more forces act on an object, then the forces combine to make a **net** (overall) force.

What happened when both of you pushed or pulled with an equal force?

TEACHER'S NOTE

Nothing happened as the learner remained stationary.

When the forces are equal to each other and opposite in direction, they balance each other and we say that the net force is 0 N.

What happened when one of you pushed or pulled harder than the other person?

TEACHER'S NOTE

The learner in the middle moved in the direction of the bigger force.

When the forces are acting in opposite directions, but are not equal, we say that the net force is greater than 0 N. There is a **resultant force**. If the forces are equal and acting in the same direction there will also be a resultant force.

Imagine a tug-of-war. People on either side pull on the rope. If they exert forces of equal size then the rope remains stationary. If one group is able to exert a larger force than the other group, then the rope will move in the direction of the larger force. This is because the forces are unbalanced and there is a **net** (resultant) force acting in the direction of the larger force.

TAKE NOTE

If you take Physical Sciences in Gr. 10-12, you will study Newton's laws in more detail in Gr. 11. You will see how these three laws laid the foundation for classical mechanics, one of the oldest and largest subjects in science, engineering and technology.



Playing tug-of-war

TEACHER'S NOTE

If you have a rope you can get the learners to have a tug-of-war outside on the school field. You can have the children on one side pull while the other side remains idle. Then have both sides pull at the same time. This would be a good way to have the learners feel the effects of the forces on their own bodies.

You also saw that one of you could pull and the other could push in the same direction. In this case, there was a much larger net force as both forces were acting in the same direction and so they add together to produce a bigger overall net force.

We can work out the net forces acting on a body. To do this, we first need to speak about how we represent the forces acting on a body.

Representing forces

How do we show a force? When we want to draw a diagram to show what forces are acting, we use arrows to represent the forces. We always show forces acting from the centre of the object on which it acts.

If we were to draw the force on a ball when it is pushed, it could look like this:

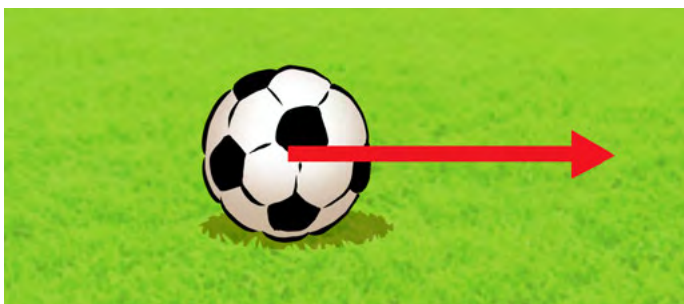

The direction of the arrow shows the direction in which the force is acting, and the length of the arrow is an indication of the size of the force. A small force would be shown with a short arrow. A large force would be shown with a long arrow.

More than one force can act on an object at the same time. The effect of the different forces acting together depends on how big each force is and what direction each force is acting in.

Let's look at how we can represent the following situation: Jabu pulls Rod's arm with a force of 10 N, while Viantha pulls Rod's other arm with a force of 6 N.

VISIT

Discover more online as you interact with this simulation on forces and motion.

bit.ly/1gme5Cr

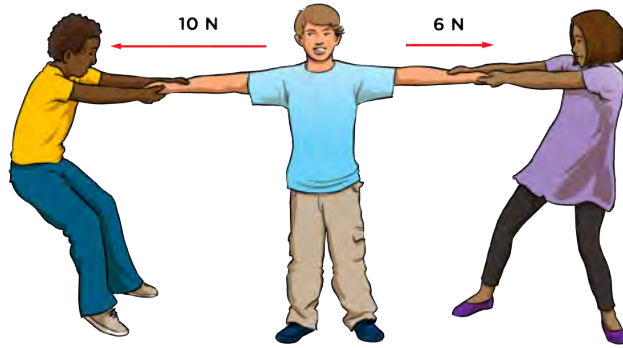

We can represent the forces acting on Rod in the following way: we use a circle to represent Rod and different length arrows to represent the forces acting on him. This is called a free-body diagram.

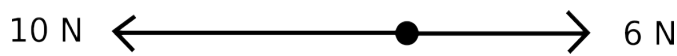

What is the net force acting on Rod? We can calculate it as follows:

$$\text{net force} = 10 \text{ N} + (- 6 \text{ N}) = 4 \text{ N to the left.}$$

If the forces all act in the same direction then the net force is the sum of the different forces.

Imagine you are pushing someone in a go-cart, and your friend comes to help you push harder. There are now two forces acting on the person in the go-cart. These forces are acting in the same direction so they are added together to produce a net force which is the sum of the two smaller forces.

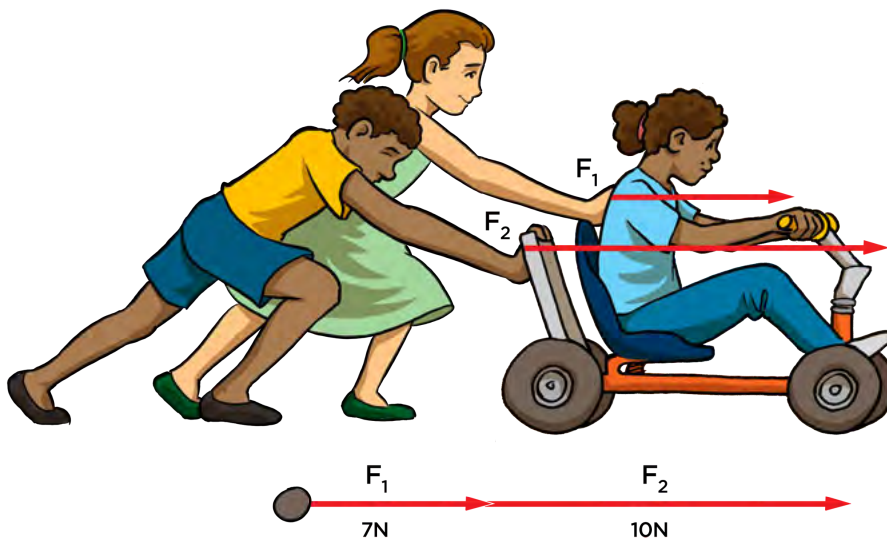

TAKE NOTE

The force exerted by Viantha is given a negative value as it is in the opposite direction to the force exerted by Jabu.

TEACHER'S NOTE

This is an optional activity which you can do with learners if you have internet access to run the PhET simulations.

Activity: Tug of war**MATERIALS:**

- PhET simulation: *Forces and Motion: Basic*¹ bit.ly/199udkj

It would be a good idea to familiarise yourself with the simulation before allowing the learners to use it. This will ensure that you can help them if they encounter problems with the simulation. When using the programme, it is important that learners stop the simulation each time before adding another force. This link is a pdf download with helpful hints on how to use the simulation: ² bit.ly/1cXIC8y

INSTRUCTIONS:

1. Open the webpage. Click on the button marked "Run".
2. Tick all the boxes in the top right corner.
3. Place the blue and red team in such a way that the forces are balanced.
4. Draw a free body diagram to show the forces acting on the cart. Show the net force (sum of the forces)

Note: The diagram will be learner dependent. They will have chosen a particular combination of blue and red team members in order to achieve a balanced set of forces. Encourage them to play around with the simulation rather than just choosing the first answer they find. Show them that there are many correct combinations. The diagram they draw should have two arrows of the same length facing in opposite directions and the net force should be equal to zero. Remember never to draw the net force. The simulation will show them the correct answer.

1. Reset the simulation.
2. Place the blue and red team members in such a way as to create an unbalanced force.
3. Draw a free body diagram to show the forces acting on the cart.

Note: The vector diagram will be learner dependent. They will have chosen a particular combination of blue and red team members in order to achieve an unbalanced set of forces. Encourage them to play around with the simulation rather than just choosing the first answer they find. Show them that there are many correct combinations. The diagram they draw should have two arrows of different lengths facing in opposite directions. The simulation will show them the correct answer.

Point out to learners that unbalanced forces result in a change in motion (acceleration) of a body. In the case of the cart, the unbalanced forces are acting in opposite directions and combine by subtraction. But unbalanced forces can also act in the same direction, for example, if two people are pushing the cart with different forces causing it to accelerate forward, the unbalanced forces combine by addition, as opposed to subtraction.

How do we measure a force? We use an instrument called a spring balance. A spring balance is a simple device consisting of a spring which, when stretched, gives a reading of the force used to stretch the spring.



A spring balance.

Types of forces

So far, we have looked at forces acting on an object when the object causing the force is in contact with object experiencing the force. Do we always have to be in contact with an object in order to exert a force?

ACTIVITY: Can forces act over a distance?

TEACHER'S NOTE

This is a short, optional activity to introduce the idea of different types of forces. It can be done as a brief demonstration in front of the class to save time.

MATERIALS:

- bar magnets
- metal paper clips

INSTRUCTIONS:

1. Place one of the bar magnets on the table.
2. Bring the north end of another bar magnet close to the south end of the first bar magnet. What happens?
The bar magnets move towards each other
3. Bring the north end of one bar magnet close to the north end of the other bar magnet. What happens?
The magnets try to push each other away.
4. Place the paper clips on the table.
5. Bring a bar magnet over the paper clips. What do you observe?
The paper clips are attracted to the bar magnet.

QUESTIONS:

1. Did you have to touch the bar magnets together before they would attract each other?
No.
2. Did the paper clips move towards the magnet?
Yes
3. What caused the movements?
The magnet exerted a force on the other magnet or the paper clips.



VISIT

Learn more about Hooke's Law and how springs stretch depending on the mass with this simulation.
bit.ly/1cwebT9



There were forces exerted by the magnets but they did not have to touch each other. That means that you do not have to be in contact with something in order to exert a force on it.

There are two types of forces:

- **Contact forces:** objects are in contact with each other and exert forces on each other.
- **Non-contact (field) forces:** objects are not in contact with each other and exert forces on each other.

We are now going to look at these two broad groups of forces in more detail.

1.2 Contact forces

Contact forces are forces between objects which are touching each other. Most of the forces that we looked at in the previous section were contact forces, for example, when you push a desk, or pull a go-cart. You are touching the object.

Friction

What happens when you kick a ball across the grass? The ball moves quickly at first but then slows down again. Something has caused the ball to slow and stop moving. If the motion of the ball has changed then a force must have been exerted on it. The force which opposes motion is called **friction**. Friction forces always act in the opposite direction to the motion of the object. Friction resists movement when the object and surface are in contact. What does that mean? It means that if the ball is moving forward then friction acts backwards on the ball.

The following image shows a ball which has just been kicked. Draw an arrow to show in which direction friction would be acting.

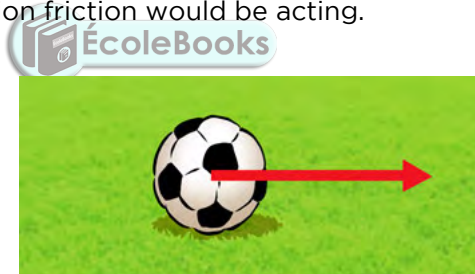

TEACHER'S NOTE

Learners must draw the arrow in the opposite direction to the red arrow.

TAKE NOTE

As we will see later on, there are also other forces acting on this system such as friction and weight.

What factors will affect the amount of force required to move objects? We need to look at all the forces acting on an object. Do you remember the following diagram from the beginning of the chapter?

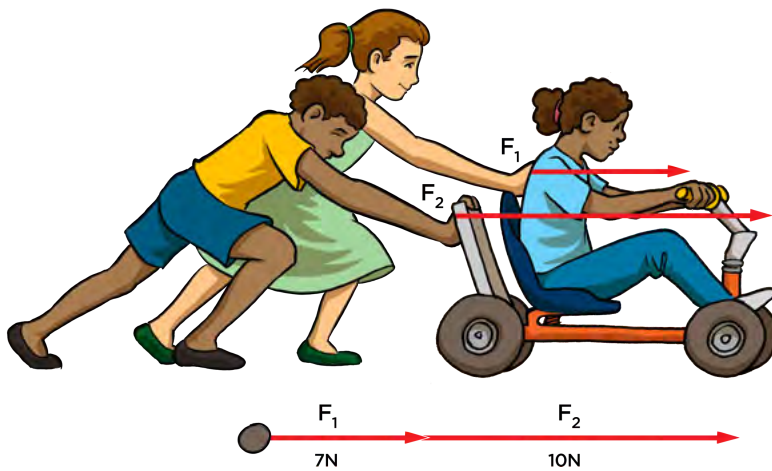

We only showed the forces of the two learners pushing on the go-cart. What other forces are acting on this go-cart as it moves along?

Friction is acting on the go-cart in the opposite direction to the motion of the go-cart. The go-cart also has a weight. As we learnt in Gr. 8 Planet Earth and Beyond, an object on earth has weight due to the gravitational force of attraction of the Earth on the object. This is a force acting on an object.

We can now draw the friction and weight in the free-body diagram of the forces acting on the go-cart as follows.

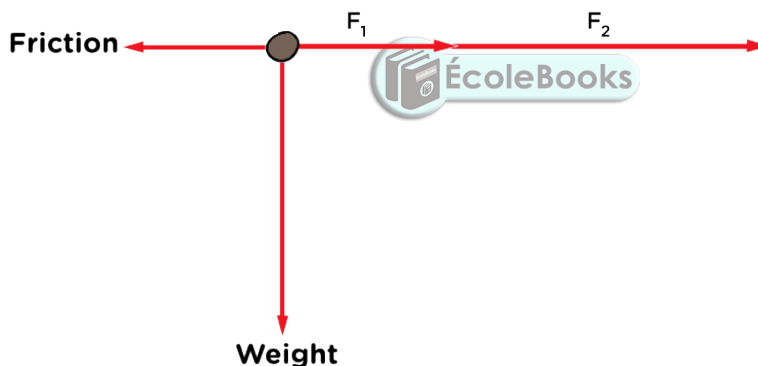

TAKE NOTE

We will learn more about weight and the gravitational force in the next section.

There is another force acting on the go-cart. Think of when you stand on the ground: you feel the ground beneath your feet. This contact force is preventing you from penetrating the ground. This is called the **normal force**. The normal force always acts perpendicularly to the surface that the object is resting on.

In simple situations such as when you are standing on the ground or the go-cart is travelling along a level surface, then the normal force is equal to the weight of the object, but in the opposite direction. Think back to what we learnt about forces acting in pairs. On a flat, level surface, the normal force is the reaction force to the weight of the object. This is shown in the diagram for a box resting on the floor.

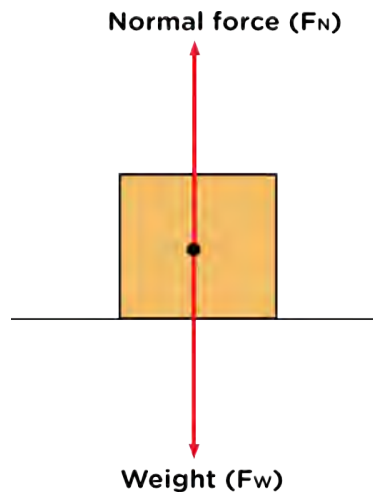

We can now complete the free-body diagram of the forces acting on the go-cart as follows,

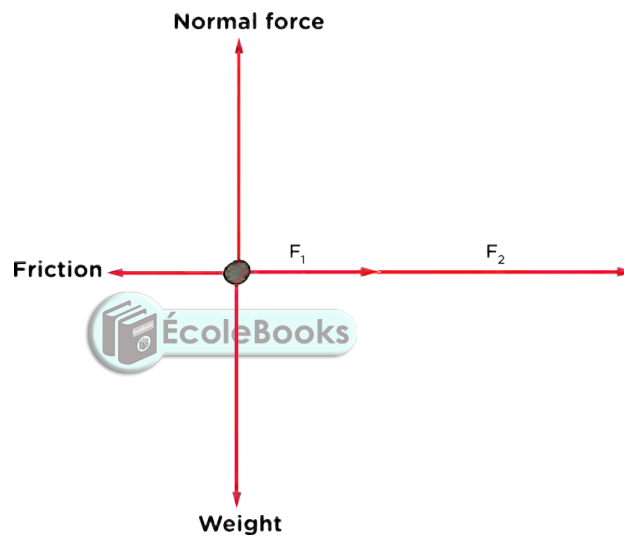

VISIT
Explore the forces at work when you try to push a filing cabinet in this simulation.
bit.ly/19OewvW

Do you think there is a relationship between the friction that a body experiences and the normal force? Let's investigate.

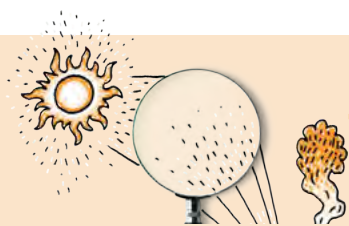

INVESTIGATION: What is the relationship between the normal force and friction?

TEACHER'S NOTE

This investigation will show the students that the frictional force is related to the **normal force**. The normal force is the reaction of the surface to the weight of an object.

As long as you have a scale you can use any objects as mass pieces. The learners will need to use the spring balances to measure the forces that they exert on the blocks. It is important that they measure the force as the block starts moving, because the reading will drop once the block is moving since kinetic friction is less than static friction.

Learners have already been introduced to weight in previous grades and will cover it in more detail in the next section where they will actually calculate gravitational acceleration for themselves. For now, just use the value of $g = 9,8 \text{ m/s}^2$ and then you can refer back to this investigation when learners work out gravitational acceleration for themselves later on.

INVESTIGATIVE QUESTION: What is the relationship between the normal force and friction?

AIM: To determine the relationship between the normal force and the size of the frictional force.

In the situations that we are going to investigate, the object will be pulled along on a flat, level surface. We will increase its mass and measure the resulting frictional force. But how does this relate to the normal force?

Where the object is on a flat level surface, the normal force is equal to the weight. As you learnt in Gr. 8 Planet Earth and Beyond, and will see in the next section, we can calculate the weight of an object. We can therefore calculate the normal force acting on the object.

For this investigation, calculate the weight using the formula $W = m \times g$, where m is the mass of the object in kg and g is $9,8 \text{ m/s}^2$. We will learn more about this in the next section.

MATERIALS AND APPARATUS:

- wooden blocks with different known masses or mass pieces
- wooden block with a hook
- spring balance
- triple beam balance or electronic scale

TEACHER'S NOTE

Any mass measuring device would be suitable for this investigation.

TAKE NOTE

We take three readings and then calculate an average. This increases the reliability of the results.

METHOD:

1. Measure the mass of the wooden block with a hook with the triple beam balance. Record the mass in the table. Calculate and record the normal force.
2. Put the wooden block with the hook on the table. Attach the spring balance to the hook. Make a small mark on the desk from which to start pulling the block.
3. Pull sideways to the point that the block just starts moving.
4. Record the force reading in the table below. Repeat this three times for the wooden block.
5. Put a mass piece on top of the wooden block. Record the total mass. Calculate and record the normal force. Pull it sideways to the point that it starts to move. Record the force. Repeat this three times. In each case, start the block from the same position and pull gently.

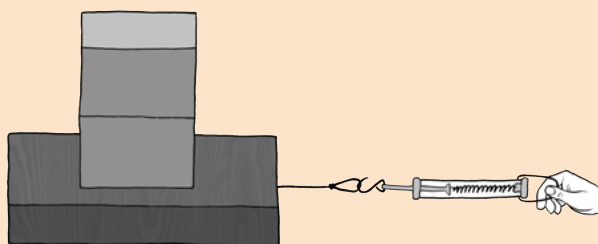

6. Repeat the experiment for larger masses and complete the table.

RESULTS:

TEACHER'S NOTE

The results obtained will depend on the mass of blocks used and the surface on which the investigation is carried out. It is important that the learners see that as the mass increases, the normal force increases and the the reading on the spring balance, measured as the block begins to move, also increases.

TAKE NOTE

We are measuring the **static friction**, which is the friction between two objects that are NOT moving. We measure it as the minimum force required to start the block moving.

Table to record the force required to overcome the frictional force and move the block.

Mass (kg)	Normal force (N)	Reading 1 (N)	Reading 2 (N)	Reading 3 (N)	Average (N)

Plot a graph of the average force applied to the block at rest against the normal force of the block.

1. Which is the dependent variable?
The size of the frictional force.
2. Which is the independent variable?
The normal force as a result of the mass of the blocks.

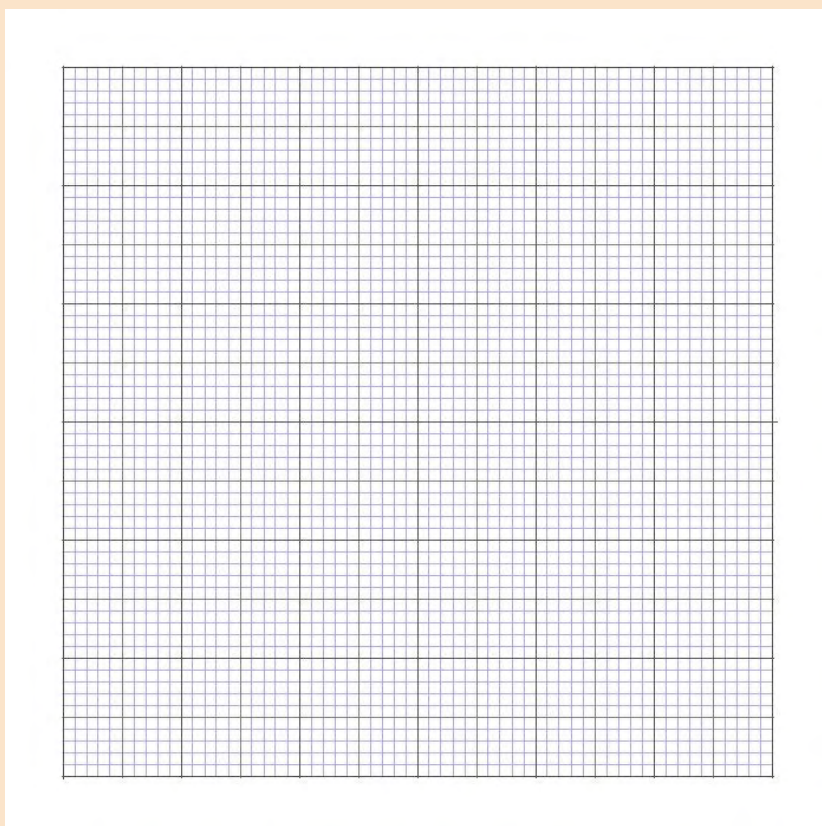

ANALYSIS:

1. Draw a labelled free-body diagram of all the forces acting on the block just as it is about to start moving.

An example free-body diagram. The weight and normal force must have arrows of equal size. The pulling force must be equal in size to the friction as the diagram represents that object just as it is about to start moving.

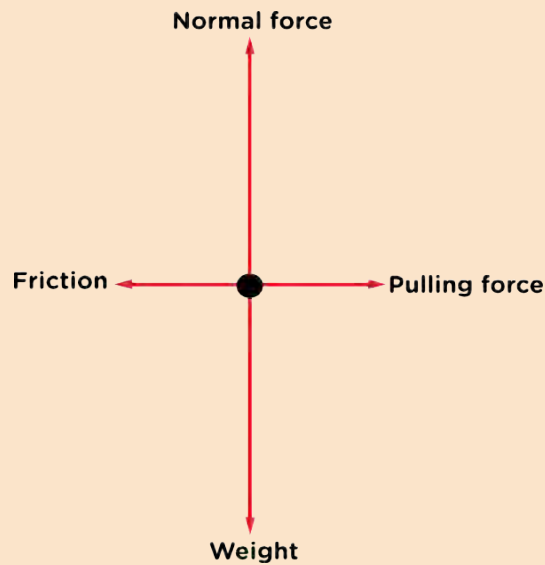

TAKE NOTE

The force applied to the point at which the block starts to move is equal to the frictional force acting on the block.

2. Why is the weight on the block being changed when the aim of the investigation is to find out how the normal force affects frictional force?

The object is on a flat surface so the normal force equals the weight. Increasing the mass, increases the weight as $W = m \times g$, therefore the normal force increases.
3. Why are three readings taken for each setup and an average calculated?

Repeating the experiment increases the reliability of the results.
4. What is the shape of your graph?

The shape should be a straight line through the origin. The actual shape will depend on the accuracy of the learners' results and plotting. It is only important that the graph shows an increasing trend so that the relationship between the normal force and friction can be established.
5. What does the shape of the graph tell us about the relationship between the normal force of the block and the friction force?

The shape tells us that as the normal force increases, so does the size of the friction force.
6. What do you think would happen if the block was not placed on the smooth desk, but rather on a rough surface, or a much smoother surface? Will this affect the results?

Yes, this will affect the result as the frictional force between different kinds of surfaces is different, for example between smooth and rough surfaces.

CONCLUSION:

1. Write a conclusion for this investigation.
The friction force increases as the normal force of the object increases.
2. Repeat the investigation and take some readings from the spring balance once the block is moving. How do the readings for the stationary block and a moving block compare? Is there a difference?
When the block is moving at constant speed, the friction decreases, compared to the friction that has to be overcome to make the block move.

TEACHER'S NOTE

Static friction is the maximum friction reading just as the block starts to move. Then, when the block is moving at a constant speed, the friction decreases and is called moving friction. In the first part of the investigation, we only measured the average static friction with different masses. This extension will show learners that once the object starts to move, the friction decreases.

TEACHER'S NOTE

This is an optional activity which you can do with learners if you have internet access to run the PhET simulations.

Activity: Friction

MATERIALS:

- PhET simulation: *Forces and Motion: Basic*³ bit.ly/199udkj

Note: It would be a good idea for you to familiarise yourself with the simulation before allowing the learners to use it. This will ensure that you can help them if they encounter problems with the simulation. This link is a pdf download with helpful hints on how to use the simulation: ⁴ bit.ly/1cXIC8y

INSTRUCTIONS:

1. Open the webpage. Click on the button marked "Run".
2. Choose the tab labelled "Friction".
3. Tick all the boxes in the top right corner.
4. Choose one of the crates from the selection box and drag it next to the man.
5. Exert a force on the crate. Slowly increase the amount of force exerted until the crate begins to move.

QUESTIONS:

1. Before the object starts moving, what do you notice about the size of the friction force compared to the size of the applied force? Are they balanced or unbalanced?

The forces are unbalanced. The friction force is greater than the applied force.

1. After the object starts moving, what do you notice about the size of the friction force compared to the size of the applied force? Are they balanced or unbalanced?

The forces are unbalanced. The applied force is greater than the friction force.

1. What have you learnt about getting an object to move?

There needs to be an unbalanced force in order for the object to move. The applied force needs to be greater than the friction force.

The force of friction depends on the type of surface on which an object is moving and the normal force. In order to get an object to move, a force greater than the frictional force needs to be applied in order to overcome the friction between the object and the surface.

We can now look at the example of pushing a friend in a go-cart again. There is friction between the go-cart and the ground. The friction acts in the opposite direction to the forces pushing the go-cart forward. Therefore, if there are two forces of 7N and 10N pushing the go-cart forward, and the friction is 5 N, we can show only these forces as follows:



What is the net force acting on the go-cart?

VISIT

Learn more about how friction causes a material to heat up and melt. Rub two objects together and they heat up. When one reaches the melting temperature, particles break free as the material melts away.

bit.ly/190eYdz

TEACHER'S NOTE

12 N to the right.

Friction is advantageous for a number of reasons. For example, the friction between our feet and the ground enables us to move forward and prevents us from slipping. Friction is also involved in keeping cars from skidding as the tyres experience friction between the tread and the roadway.

Tension and compression

TEACHER'S NOTE

In order to introduce these forces, a suggestion is to bring different objects to class to experiment with. An ideal object is a piece of foam as you can then show tension and compression by pulling and pushing it, respectively, and also bending it.

There are other forces which are contact forces. Look at the following drawing of a boy pulling on a block with a rope.

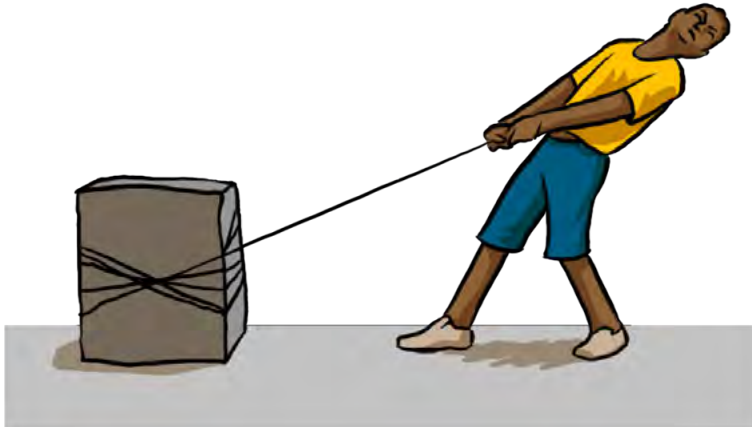

The person is pulling the rope which is pulling the block. The person is not touching the block directly. The person is pulling the rope and the block is pulling back on the rope in the opposite direction. This causes a **tension** force to exist in the rope. The rope is tight and so there is tension in the rope. Tension is a contact force. The tension in the rope pulls the block across the floor.

Another example of a contact force is **compression**. A compression force is a force which acts to deform or squash an object. Let's think of some examples.

TEACHER'S NOTE

Provide the class with play dough and have them form balls which they can then compress in their hands as in the picture below.

If you take a ball of dough and crush it with your fingers, you are exerting a compression force on the dough. The dough changes shape. It deforms. Another example is crushing a tennis ball or a cooldrink can between the palms of your hands.



Crushing dough.



Compressing a tennis ball.

Can you think of some other examples?

TEACHER'S NOTE

Learner-dependent answers.

The following diagram summarises the difference between tension and compression.

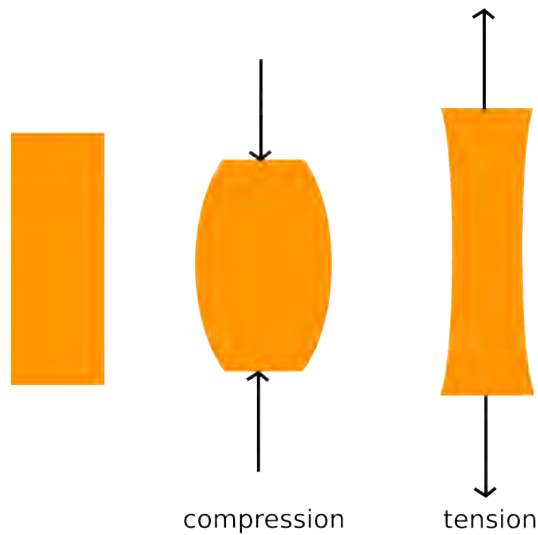

Tension forces are two forces acting on one object in opposite directions (away from each other) to stretch the object. Compression forces are two forces acting on one object in opposite directions (towards each other) to compress or deform the object.

There are many other examples of compression forces in everyday life. A bridge experiences both compression and tension due to the weight of the cars and other vehicles which pass over it as shown in the following diagram.

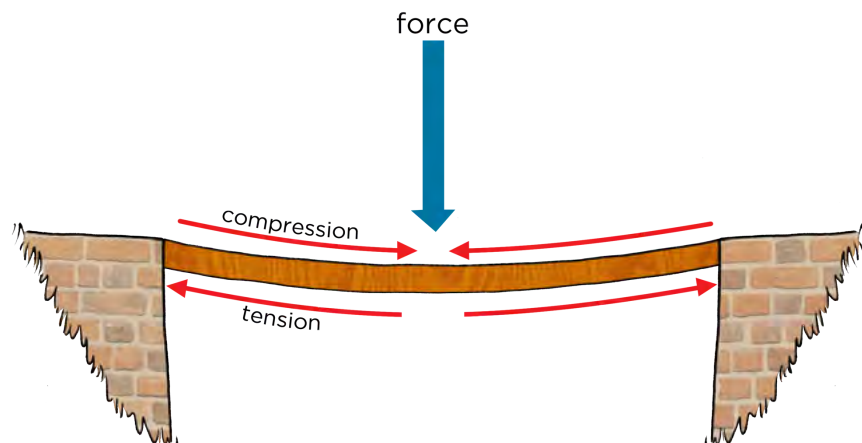

We have been looking at contact forces, which include friction, normal forces, compression and tension. We are now going to look at the forces that act between bodies which do not touch.

1.3 Field (non-contact) forces

A field is a region in space where an object (with certain properties) will experience a force. Field forces are non-contact forces. Non-contact forces are forces which act over a distance. They do not have to be touching.

The most common examples of fields are:

- gravitational field
- magnetic field
- electric field

When we discussed contact forces, we spoke about pushes and pulls. However, with field forces, it is better to talk about **repulsion** and **attraction**.

Gravitational forces

Have you ever wondered why things fall down and not up?

TEACHER'S NOTE

You can demonstrate the gravitational effect by dropping objects of different masses from an equal height. Use a tennis ball and a balled-up piece of paper (so that they are approx. the same size and shape). Drop them from the same height and see if the learners can see a difference in the way that they fall. Ask the learners why they think the objects fell. Is something pushing them down? Or pulling them down? Get them to discuss their ideas with each other.

The simulations provided in this chapter are very worthwhile looking at if you have internet access. Otherwise, encourage learners to interact with them in their own time at home or on their mobile phones.

TEACHER'S NOTE

Learners have already come across gravity in Planet Earth and Beyond in previous grades.

The force which causes things to fall down towards the Earth and prevents us from falling off the planet is the **gravitational force**. Gravitational forces exist between any two objects with mass and they are forces of attraction (pull).

VISIT

What is gravity?
bit.ly/1gN57fo

TEACHER'S NOTE

Strictly speaking, when talking about "gravity" we are specifically referring to the gravitational force of attraction that occurs between the Earth (or another celestial body like a planet) and other objects, as opposed to the gravitational force in general which acts between any two objects with mass. For example, we would refer to the gravitational force acting to attract objects to the Moon as the gravitational force due to the Moon.

TAKE NOTE

Gravity is a force and is therefore measured in Newtons.

The gravitational force is a force that attracts objects with mass towards each other. *Any object with mass exerts a gravitational force on any other object with mass.* The Earth exerts a gravitational pull on you, the desks in your classroom and the chairs in your classroom, holding you on the surface and stopping you from drifting off into space.

The Earth's gravitational force pulls everything down towards the centre of the Earth which is why when you drop an object like a book or an apple, it falls to the ground. However, do you know that you, your desk, your chair, and the falling apple and book exert an equal but opposite pull on the Earth?

Why do you think these forces on the Earth do not cause the Earth to move noticeably?

TEACHER'S NOTE

The Earth has a much larger mass than a person or a desk and so it is accelerated by a much smaller amount even though the force exerted on the Earth by a desk is the same size as the force exerted on the desk by the Earth (just in opposite directions). This is why the Earth does not move noticeably.



The arrows show the direction of the gravitational field of the Earth. The arrows all point towards the centre of the Earth because the gravitational force is always attractive.

TEACHER'S NOTE

The PhET simulation in the visit box can be used to demonstrate very easily how the gravitational force between two objects increases with mass and decreases as the distance between the objects increases. You can turn off the values, and use the position of the little figures tugging on the ropes to demonstrate the relationships qualitatively.

The Earth attracts us because it has such a large mass and so we are attracted downwards towards the centre of the Earth all the time.



These army skydivers have just jumped out of the back of a plane and fall towards the Earth due to gravity.

VISIT

Interact with this simulation to see the relationship between gravity and the masses of the objects and distance between them.

bit.ly/16PDe2w
bit.ly/1dLLZMn

The bigger the mass of the objects, the greater the force between them. This means that two small objects would have a very weak gravitational attraction and so it has no noticeable effect. However, bigger objects such as the Moon and the Earth have a much greater gravitational force.

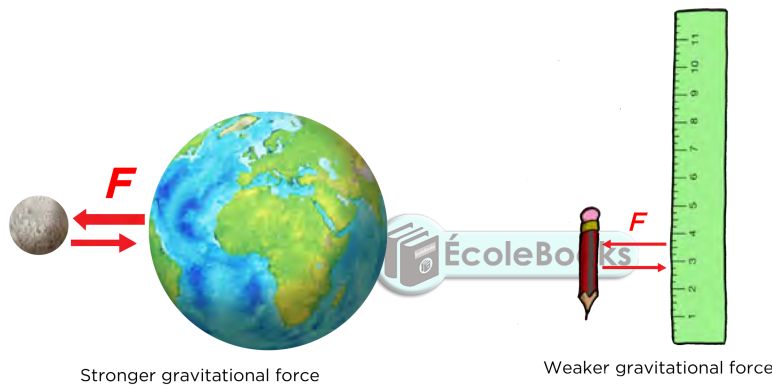

VISIT

Move the Sun, Earth, Moon and space station to see how it affects their gravitational forces and orbital paths.

bit.ly/199wWdE

As we know from Planet Earth and Beyond, all the planets in our solar system are held in orbit around the Sun by the gravitational force of attraction between the Sun and planets.

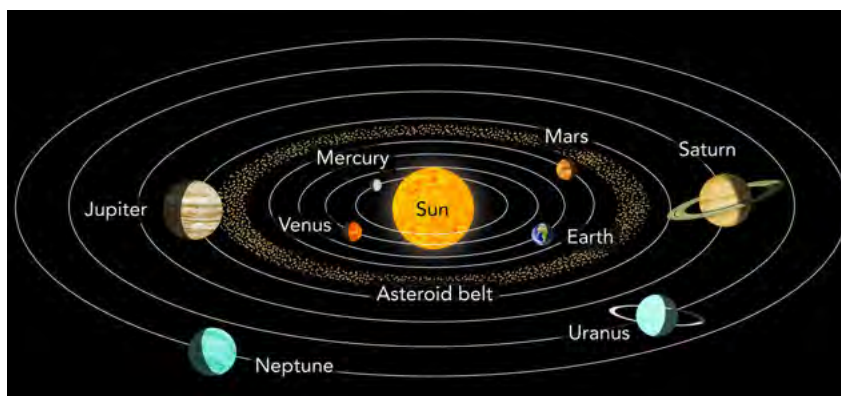

The planets move around the Sun in our solar system. There is a gravitational force of attraction between the Sun and planets, and between planets and their moons.

VISIT

Build your own solar system with this simulation and experiment with the masses and orbits. bit.ly/1hYfnzd

The second factor which affects the gravitational force of attraction between objects is the distance between them. The further objects are away from each other, the smaller the gravitational force.

All the components in our Universe are held together by a gravitational force. In summary we can say:

- The **greater the mass** of the objects, the stronger the gravitational force of attraction between them.
- The **closer objects** are to each other, the stronger the gravitational force between them.



INVESTIGATION: Dropping objects

TEACHER'S NOTE

A note on falling objects

A useful way to demonstrate the Earth's gravity is to look at falling objects. An optional extension activity is included below in which learners drop a variety of objects. You can take a vote from the class to see whether learners think that an apple or bag of sugar would hit the ground first. (Answer: they would hit the ground at the same time as long as air resistance is negligible.) It is very likely that learners will have the preconception that heavier items fall faster. It is not important at the moment that the learners' answers are correct and do not try to lead them to the correct answer. They will hopefully discover it for themselves in the following experiment.

In this investigation learners need to work in pairs. They will initially drop a whole apple and half an apple from the same height at the same time. They will then further experiment with balls of different masses (but the same size) and balls of the same mass (but different volumes). It is very hard to drop objects at exactly the same time so that they hit the floor simultaneously so let the learners repeat the experiment several times until they are confident that they are dropping the objects at the same time. If it is hard for them to see which object hits the ground first, suggest to learners that they listen for the number of sounds they hear - one or two - when the objects hit. Learners might need to repeat this investigation many times since it most likely contradicts their preconceptions. Safety tip: It is probably a good idea to have the apples cut in half ahead of time.

Once the learners have finished their experiment you can demonstrate the effects of air resistance by dropping a hammer and a feather. Have the learners take a vote on what will happen when you drop the hammer and feather. Be ready to explain to learners that air resistance slows the fall of the feather and that if there were no air resistance the two would fall at the same rate and hit the floor at the same time.

INVESTIGATIVE QUESTION:

Do different objects fall at the same rate?

HYPOTHESIS:

What do you think will happen?

TEACHER'S NOTE

Learner-dependent answer.

MATERIALS AND APPARATUS:

- hammer
- feather
- two balls of the same mass, different volumes (one set per pair)
- two balls of the same volume, different masses (one set per pair)

METHOD:

1. Work in pairs, take turns to be the person who drops an object (experimenter) and the person who observes the objects dropping (observer).
2. Complete the "prediction" column in the table below.
3. Experimenter: stand on top of a chair or desk and take the two balls of the same mass, with one in one hand and the other in the other hand.
4. Experimenter: hold the two balls up at the same height in front of you and drop them at exactly the same time.
5. Observer: note what happens, in particular which lands first.
6. Swap positions and repeat the experiment using two balls which have the same volume but different masses.
7. Your teacher will now do a demonstration for you and drop a hammer and a feather. Before your teacher drops the hammer and feather, record the prediction column for the hammer and feather drop.
8. Record what happened with the hammer and feather and answer the questions below.

RESULTS AND OBSERVATIONS:

1. What did you keep constant in this experiment?
The height at which objects are dropped.
2. What did you change in this experiment?
The type objects that are being dropped, in particular the mass and volume of the objects.

VISIT

Video of feathers and coins
falling in a vacuum
bit.ly/lgpXaiB

In the table below, record what you think will happen in the "prediction" column before you conduct your experiment. Assuming that you drop each pair of objects from the same height at the same time, what do you think will happen? Which do you think will land first?

Objects	Prediction	Observation
Balls: same mass, different volume		
Balls: different mass, same volume		
Hammer and feather		

EVALUATION:

How reliable was your experiment? How could you improve your method?

TEACHER'S NOTE

Learner dependent answer. Example answers could include: It is difficult to drop objects at exactly the same time. It would be better to drop the objects from a greater height. Air resistance could have affected the results and it would be better to drop the objects in a vacuum.

CONCLUSIONS:

Write a conclusion for this investigation.

TEACHER'S NOTE

Learners should have found that the half apple and the whole apple hit the floor at the same time. They should also have found that the balls of the same mass hit the floor at the same time and also the balls of the same volume hit the floor at the same time. From this they should conclude that all objects dropped fall at the same rate no matter what their shape or size if air resistance can be ignored.

Advanced:

The objects *accelerate* at the same rate). In the case of the hammer and feather drop, learners should have found that the hammer landed first. This is because of the effects of air resistance slowing the feather's fall.

QUESTIONS:

1. Which landed first, the apple or the half apple?
They should have both landed at the same (or close to the same) time.
2. Considering the balls of the same mass, which landed first, the larger one or the smaller one?
They should have both landed at the same time.
3. Considering the balls of the same volume, which landed first, the heavier one or the lighter one?
They should have both landed at the same time.
4. Why do you think the two dropped balls always landed at the same time?
In an ideal situation, all objects dropped from the same height will land at the same time. This is because the Earth's gravitational force causes each object to get faster by the same amount every second, no matter how heavy it is or what its volume is.

Advanced Teacher Note:

According to the Universal Law of Gravitation, the Earth's gravitational force pulls down on an object with a force that is proportional to the mass of the object and the mass of the Earth. In all cases the mass of the Earth is the same and so any differences in the gravitational force on objects on Earth depends only upon the difference in the mass of the objects being dropped.

According to Newton's second law, the net force exerted on an object, F , is given by $F=ma$ where m is the mass of the object and a is the acceleration



produced by the net force F .

5. Why do you think the hammer landed before the feather?

In a real situation, the air around us affects how objects fall. As an object moves through the air, and experiences air resistance. The feather is much lighter than the hammer and so the effect of air resistance is much larger on the feather. The net force acting downwards on a falling object is the gravitational force minus force due to air resistance. As the feather is much lighter than the hammer, the net force acting on it will be less and so it will experience a smaller acceleration towards the ground and fall more slowly.

TEACHER'S NOTE

Advanced Teacher Note:

Air resistance is a drag force acting to slow the object down. The size of the force depends upon the velocity of the falling object squared, the surface area of the falling object, and the density of the fluid it is falling in (in this case air). Very light objects are slowed by air resistance, like feathers or thin sheets of paper. This is because their gravitational force is very small compared to the air resistance. Very large objects are also slowed by air resistance. This explains why a parachute slows your fall. Before you open a parachute air resistance is small. After opening, the wide parachute experiences greater air resistance which then slows you down.

TEACHER'S NOTE

It is very important that learners understand the difference between mass and weight. In science, weight is a force, but learners are used to using the word "weight" when describing their mass. Weight is the force experienced by an object due to gravity. On Earth, all objects are attracted downwards towards the centre of the Earth and our weight is an indication of the size of that attraction. Weight will vary depending on our position in space but our mass should remain constant regardless of our position.

You have probably heard the term 'weight' used many times before, either in your Natural Sciences classroom, or in conversation with others. Many people use the term weight incorrectly in everyday language. For example, a relative may say to you "My weight increased by 2 kgs over the holiday period as I ate too much food." What is wrong with this statement? Discuss this with your class and teacher.

TEACHER'S NOTE

This statement is incorrect as the relative is equating her/his weight with kilograms. Kilograms are a measure of mass, not weight. Her mass might have increased by 2 kilograms.

The **mass** of an object is the amount of matter in the object. It tells you how many particles you have. Do you remember learning about atoms in Matter and Materials?

So, for example, the mass of a wooden block tells us how many atoms there are. Mass is measured in kilograms (kg) and is independent of where you measure it. A wooden block with a mass of 10 kg on Earth also has a mass of 10 kg on the Moon.

However, an object's **weight** can change as it depends on the mass of the object and also the strength of the gravitational force acting on it. Weight is measured in newtons (N) as it is the gravitational force of attraction exerted on an object by the Earth (or Moon or any other planet). Therefore, the weight of an object will change when weighed in different places.

The weight of a 10 kg block on Earth will be different to that on the Moon. Why do you think this is? Will the weight be more or less than on the Moon?

TEACHER'S NOTE

The Earth is much larger than the Moon and so the gravitational force between the Earth and the block will be greater than the force between the Moon and the block.



INVESTIGATION: What is the relationship between the mass of an object and its weight?

INVESTIGATIVE QUESTION: What is the relationship between the mass of an object and its weight?

HYPOTHESIS: Write a hypothesis for this investigation.

TEACHER'S NOTE

Learner-dependent answer.

MATERIALS AND APPARATUS

- four mass pieces in increments of 500 g (one of 500 g, one of 1 kg, one of 1,5 kg and one of 2 kg)
- spring balance
- triple beam balance

TEACHER'S NOTE

Any mass meter can be used to measure the mass of the objects. Kitchen scales or electronic scales can also be used.

VISIT

Mass, weight and gravity
(video). bit.ly/1gxYTIZ

METHOD:

1. Measure the mass pieces on the triple beam balance.
2. Measure the weight of each mass piece with the spring balance.

- Record the mass and matching weight in the results table.
- Draw a graph of your results.
- Calculate the gradient of the graph.

RESULTS:

Record your results in the following table.

TEACHER'S NOTE

An example of the results if using the suggested mass pieces:

Mass (kg)	Weight (N)
0.5	4.8
1	9.8
1.5	14.7
2	19.6

- What is the dependent variable?
Weight
- What is the independent variable?
Mass
Therefore, weight is on y-axis versus mass on the x-axis
- Draw your graph in the space provided below.

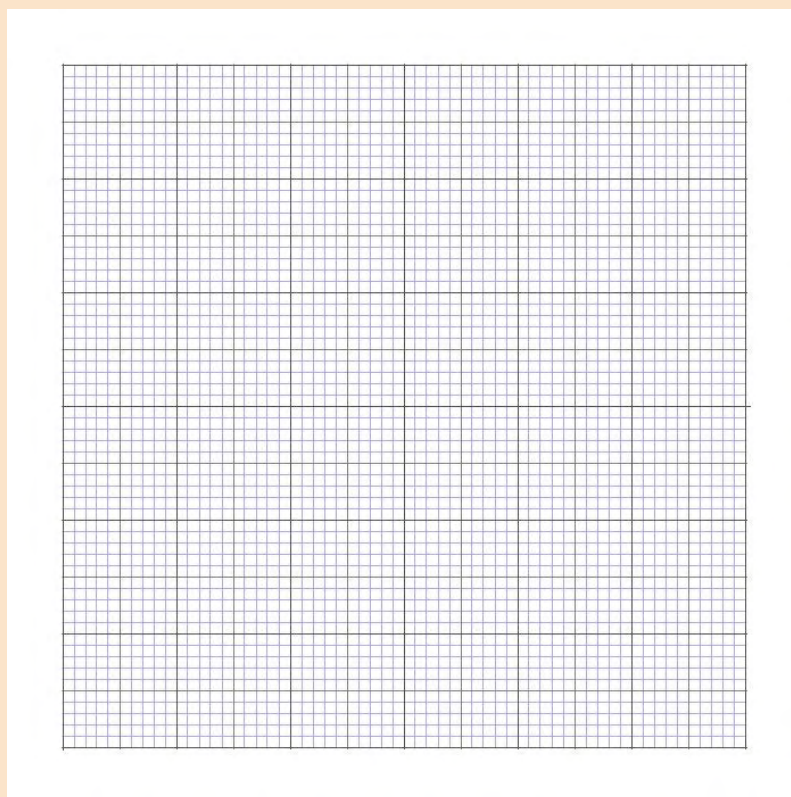

4. Your graph should be a straight line. Use the space below to calculate the gradient of your graph.
The gradient should be 9,8.

TEACHER'S NOTE

You may need to remind the learners about calculating the gradient of a straight line. They should have covered this topic in Mathematics but it would be useful to remind them. They need to choose two co-ordinates on their straight line. They can choose any two coordinates which should be labelled as $(x_1 ; y_1)$ and $(x_2 ; y_2)$. The formula for the gradient of a straight line is $\text{gradient} = \text{rise/run} = (y_2 - y_1)/(x_2 - x_1)$

Example calculation: $\text{gradient} = (9,8 - 4,8)/(1 - 0,5) = 9,8$

Learners may not get the correct answer for the gradient if they have not plotted correctly or if the spring balances are not calibrated properly. They may get an answer closer to 10. The gradient of the graph gives the gravitational acceleration on Earth. This will be explained in the text after the investigation.

CONCLUSION:

Write a conclusion for this investigation.

TEACHER'S NOTE

The weight of an object is directly proportional to the object's mass.

Weight is the force of gravity pulling you towards the centre of the Earth. It is measured in newtons. On Earth the gravitational force causes us all to accelerate towards the centre of the Earth. The acceleration is called **gravitational acceleration**.

On Earth it is $9,8 \text{ m/s}^2$. The gradient that we calculated in the last investigation should have given you a number close to $9,8 \text{ m/s}^2$ which is gravitational acceleration.

Objects are in **free-fall** when the only force acting on them is the gravitational force.

Weight (W) is calculated by multiplying an object's mass (m) by the gravitational acceleration (g):

$$W = m \times g$$

But what if you went to the Moon?

TAKE NOTE

We used this formula in the last section on friction to calculate the weight and therefore the normal force acting on an object.



The Moon is 6 times smaller than the Earth.

The Moon also has its own gravity. The strength of gravity on the surface of the Moon is one-sixth that on the surface of the Earth, and so you would weigh one-sixth of what you do on Earth on the Moon. On Jupiter you would weigh 2.5 times more than you do on Earth as Jupiter's gravity is 2.5 times that of the Earth's. Even though you would weigh different amounts (and feel lighter on the Moon and heavier on Jupiter) your actual mass would stay the same in both cases.

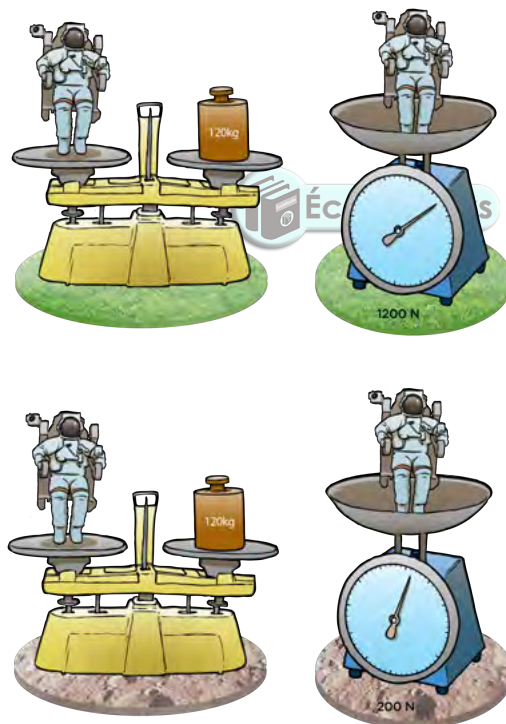

An astronaut's mass remains the same wherever it is measured. The astronaut's weight however depends on where you measure it, as you can see the astronaut weighs 1200 N on Earth but only 200 N on the Moon.

So how much would you weigh on the Moon? Imagine you have a mass of 60 kg. Your weight on Earth would be $60 \times 9,8 = 588 \text{ N}$. The gravitational acceleration on the Moon is $1,6 \text{ m/s}^2$, so your weight would be $60 \times 1,6 = 96 \text{ N}$ on the Moon.

TAKE NOTE

A bathroom scale actually measures weight and converts it to mass.



ACTIVITY: Weight and mass calculations

TEACHER'S NOTE

This is a short activity to practice some calculations. Learners can complete this as a homework task.

QUESTIONS:

1. A Ferrari has a mass of 1485 kg. What is its weight on Earth?

$$\text{weight} = 1485 \times 9,8 = 14553\text{N}$$

2. Lindiwe has a mass of 50 kg on Earth. What is her mass on the Moon?

50 kg as the mass of an object is independent of position.

3. Ian has a mass of 78 kg. His friend Sam says that he would weigh 24 N on the Moon. Is Sam correct? Explain by using a calculation.

$$\text{weight on Moon} = 78 \times 1,6 = 124,8 \text{ N}$$

Sam is incorrect.

4. You have an apple with a mass of 220 g, what is its weight on Earth and on the Moon?

$$\text{mass} = 220 \text{ g} = 0,22 \text{ kg.}$$

$$\text{weight on Earth} = 0,22 \times 9,8 = 2,156 \text{ N}$$

$$\text{weight on Moon} = 0,22 \times 1,6 = 0,352 \text{ N}$$

5. If a cow weighed 1340 N on the Moon, what is its mass?



A jersey cow.

$$\text{mass} = 1340 / 1,6 = 837,5 \text{ kg}$$

VISIT

Discover more online as you interact with this simulation using different mass pieces and springs. Transport the lab to different planets.

bit.ly/H2I6YA

TEACHER'S NOTE

The PhET simulation listed in the visit link can be used to easily show how the weight of objects change. This simulation can be used at many different levels, depending on the complexity of the concepts that you want to illustrate. A link to a pdf containing teaching tips from the PhET team is available here:

⁵ bit.ly/1hYg37K

Ever wondered what it would be like to walk around on other planets? Find out how much you would weigh on other planets in the next activity.

ACTIVITY: How much would you weigh on other planets?



TEACHER'S NOTE

This is an **optional** activity. In this activity, learners calculate what their weight would be on the seven other planets in our solar system. Although their mass remains the same, they will "feel" lighter or heavier because of the differences in the gravitational field strength on the surfaces of the other planets. You should emphasise that their mass always remains the same, but only their weight varies. If you do not have access to weighing scales you can either ask learners to estimate their mass or provide them with an example number.

MATERIALS:

- weighing scales
- calculator

INSTRUCTIONS:

1. Measure your mass in kilograms. Record the value in the table below.
2. Use the values for the acceleration due to gravity on various planets to calculate what you would weigh on that planet.

Example answers for a 50kg learner

Planet	Your mass (kg)	Value of g (m/s²)	Your weight (N)
Earth	50	9,8	490
Mercury	50	3,6	180
Venus	50	8,8	440
Mars	50	3,8	190
Jupiter	50	26	1300
Saturn	50	11,2	560
Uranus	50	10,5	525
Neptune	50	13,3	665

QUESTIONS:

1. On which planets would you feel heavier than you do on Earth?
You would feel heavier on Jupiter and Neptune.
2. On which planets would you feel lighter than you do on Earth?
You would feel lighter on Mercury, Venus, Mars, Saturn and Uranus.



The weight of a person is the force of gravitational attraction to the Earth that person experiences. Someone in free-fall feels weightless but they have not lost their weight. They are still experiencing the Earth's gravitational attraction.

The only reason the astronauts float is because they are in free-fall and their moving spacecraft is also in free-fall with them, falling at the same rate. Therefore, the astronauts appear to float when compared with the spacecraft because they are both falling at the same rate.



Astronauts experiencing weightlessness.

VISIT

Watch Felix Baumgartner's supersonic freefall back to Earth. He experienced free-fall or weightlessness.

bit.ly/1aQbE43

TEACHER'S NOTE

A note on Weightlessness

The term weightless causes a lot of confusion for learners. The confusion of a person's actual weight with one's feeling of weight is the source of many misconceptions. Weightlessness refers only to someone's sensation of their weight, or lack thereof. Weightlessness is a feeling experienced by someone when there are no external objects touching the person exerting a push or pull upon them, (we call these contact forces because they arise due to things being in contact or touching each other).

The weight of a person is the force of gravitational attraction to the Earth that person experiences. Someone in free-fall, feels weightless but they have not lost their weight. They are still experiencing the Earth's gravitational attraction.

Learners are also often confused as to why astronauts in orbit around the Earth float in their spacecraft. One common misconception is that there is no gravity in space and so the astronauts can float. In actual fact, in low Earth orbit the Earth's gravity is about 90% of its strength at the surface of Earth.

The only reason the astronauts float is because they are in free-fall and their spacecraft is also in free-fall with them, falling at the same rate. Therefore, the astronauts appear to float when compared with the spacecraft because they are both falling at the same rate. Another example is how orbiting spacecraft are essentially in free-fall as there is 'nothing' retarding their motion towards to centre of the Earth, but because of their orbital velocity, they never actually move closer to the Earth.

A great link to a video of someone experiencing free-fall is given in the Visit box.

Magnetic forces

Certain materials have strong magnetic fields around them. These are called magnets. All magnets have two poles, a north and a south pole.



An example of a bar magnet with a north and south pole.

Other materials are strongly attracted to magnets. These materials are said to be magnetic. Magnets exert forces on other magnets and magnetic materials. Which materials are magnetic? Let's investigate.

INVESTIGATION: Magnetic or non-magnetic materials

INVESTIGATIVE QUESTION: Which materials are magnetic and which are not?

HYPOTHESIS:

Write a hypothesis for this investigation.

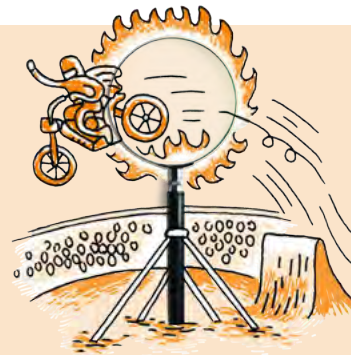

TEACHER'S NOTE

Learner-dependent answer. There are many different possible hypotheses for this investigation. An example would be: Only some materials are magnetic.

MATERIALS AND APPARATUS:

- bar magnets
- paper
- wood
- plastic
- iron
- aluminium
- steel

METHOD:

1. Hold the different items close to the bar magnet (not touching) to see if they are attracted to the magnet.
2. Complete the table indicating whether or not the items are attracted to the magnet.

TEACHER'S NOTE

Learners should notice that the non-metals are not attracted to the magnets and that the copper, even though it is a metal, is not attracted.

VISIT

How to destroy a magnet.

bit.ly/1fEFTRg

RESULTS:

Complete the following table.

TEACHER'S NOTE

Material	Magnetic (YES/NO)
Paper	NO
wood	NO
plastic	NO
iron	YES
aluminium	NO
steel	YES
copper	NO

CONCLUSION:

What can you conclude from your results?

TEACHER'S NOTE

Not all materials are magnetic. Only some metals are magnetic, such as iron.

Not all metals are attracted to magnets. Those that are attracted to magnets are known as **magnetic** materials. There are very few magnetic materials. They are iron, nickel and cobalt. Alloys which include any of the magnetic materials can also be attracted to magnets. Steel is an alloy which contains iron so steel can be attracted to a magnet.

So now we know that magnetic forces can act over a distance, but can they still act if there is something in the way? Let's find out.

TAKE NOTE

An alloy is a mixture of metals.

ACTIVITY: Can a magnetic force act through substances?

TEACHER'S NOTE

Magnetic forces are non-contact forces and can act over a distance. However, normal magnets do not have very strong magnetic fields. The further an object is from the magnet, the weaker the force experienced. A magnet should be able to act through most substances. If the object placed between the magnet and the metal is too thick, then the metal might be too far away from the magnet to experience a strong enough force. This lack of attraction is then due to the strength of the magnetic field and not the "blocking" ability of the material. In this investigation you can investigate this by using a thin piece of wood and a thick piece of wood. The magnetic field can act through the thin wood which means wood is not a "blocker" of magnetic force. So if the thick wood prevents the paper clips from being attracted it can be seen that it is the distance between the paperclips and the magnet which is relevant and not the material (wood).

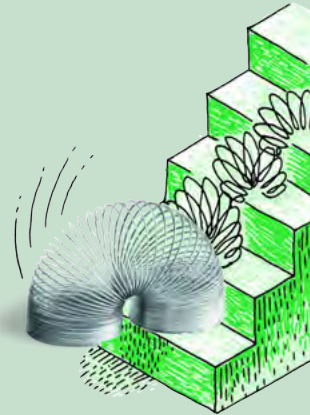

MATERIALS:

- bar magnets
- paper
- thin piece of wood
- thick piece of wood
- foil
- paperclips

INSTRUCTIONS:

1. Hold two north poles close together. What do you notice?
The two poles repel each other. There is a "pushing" force.
2. Hold two south poles close together. What do you notice?
The two poles repel each other. There is a "pushing" force.
3. Hold a north pole and a south pole close together. What do you notice?
The two poles attract each other. There is a pulling force between the poles.
4. Put the paper clips on the desk.
5. Try to pick up the paperclips with the magnet but put one of the other materials between the magnet and the paper clips. Are the paperclips still attracted to the magnet?
The magnet should work through any of the materials, as long as they are thin enough. It is the distance between the magnet and the paper clips that will affect the attraction. So the thin piece of wood should not prevent the attraction but the thicker wood will keep the paper clips far enough away from the magnet to make the attraction too weak to pick up the paper clips.
6. Try each of the different materials between the magnet and the paper clip.

QUESTIONS:

1. Were there any materials which prevented the magnet from picking up the paper clips.
The only material which may have prevented the magnet from picking up the paper clips is the thick piece of wood.

VISIT

What is the magnetic field?
bit.ly/16PF9UB

2. What does this activity tell us about the nature of the magnetic force?
It acts over a distance. It is strongest closer to the magnet and weaker as you move further away from the magnet.

In the last activity we saw that like poles repel each other but opposite poles attract each other. We have also seen that the magnetic force acts over a distance. The magnet does not need to touch something in order to exert a force on it. So a magnetic force is a non-contact or a field force.

What is a force field? Can we see it? Let's investigate if it is possible to see a magnetic field.



ACTIVITY: Visualising magnetic fields

TEACHER'S NOTE

The iron filings align with the magnetic field. Explain to the learners that the iron filings show a two dimensional view of the field but the field is actually all around the magnet, in three dimensions.

MATERIALS:

- iron filings
- two bar magnets
- paper

INSTRUCTIONS:

1. Put the bar magnet on the table.
2. Put the paper over the magnet.
3. Shake the iron filings onto the paper.
4. Use your finger to slowly push the filings around the magnet.
5. Take note of the pattern and draw it below.

TEACHER'S NOTE

This shows the pattern around a bar magnet.

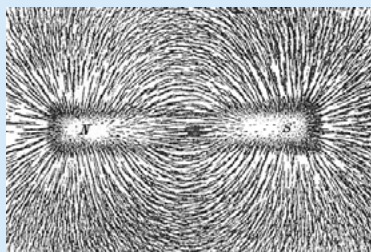

6. Lift the paper away from the magnet.
7. Place a second magnet next to the first so that different poles are facing each other.
8. Put the paper back over the magnets.
9. Move the iron filings around the two magnets, especially between the magnets.
10. Draw the pattern in the space below.

TEACHER'S NOTE

The pattern between two opposite poles attracting.

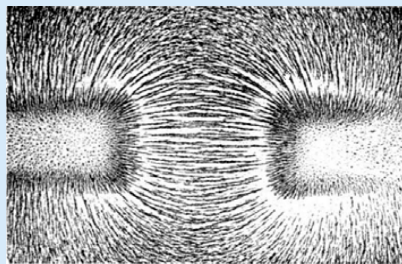

11. Lift the paper away from the magnet.
12. Move the second magnet so that the same poles are facing each other.
13. Put the paper back over the magnets.
14. Move the iron filings around the two magnets, especially between the magnets.
15. Draw the pattern in the space below.

TEACHER'S NOTE

The pattern between two like poles repelling.

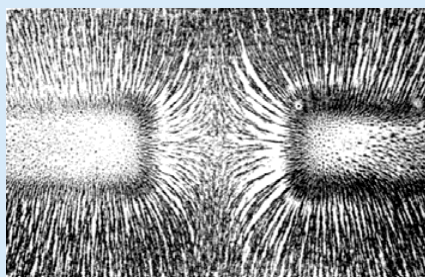

TAKE NOTE

In the last activity, the iron filings showed a two dimensional view of the field but the field is actually all around the magnet, in three dimensions.

As we have seen, it is possible to visualise the magnetic force field around a magnet. We know from our previous activities that the magnetic force acts over a distance. The field is the space around a magnet in which it can attract or repel another magnet.

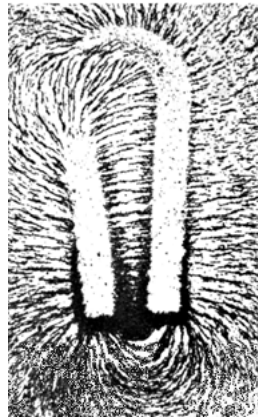

The magnetic field around a horseshoe magnet.

How do we draw a force field? The pattern you saw with your magnets can be represented by **field lines**. Field lines are used to show something we can't actually see. The closer the field lines are drawn together, the stronger the field being described. The more field lines that are drawn, the stronger the field. The field lines go from the north pole to the south pole. The following diagram shows the field lines around a bar magnet.

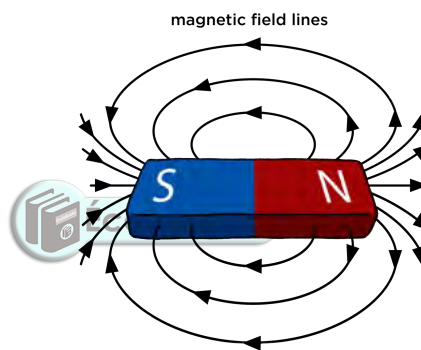

The next diagrams show the field lines between bar magnets which are attracting and those which are repelling.

Opposite poles attract.

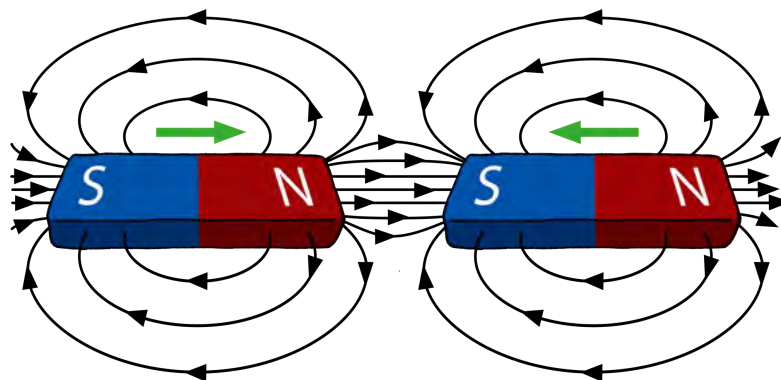

Like poles repel.

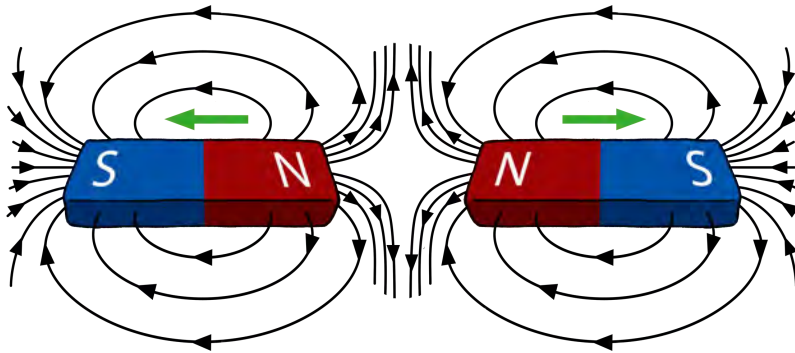

VISIT

Earth's magnetic field.
bit.ly/190i2q3

A field is strongest next to the magnet and gets weaker further away from the magnet.

Did you know that the Earth is like a bar magnet with a North and a South Pole? The Earth has a magnetic field. You can imagine Earth's magnetic field as though there is a bar magnet running through the core with the magnet's south pole under Earth's North Pole. No one knows for sure, but the theory is that the superhot liquid iron in the Earth's core moves in a rotational pattern, and these rotational forces lead to the weak magnetic forces around the Earth's rotational axis.

VISIT

Where is the True North Pole.
bit.ly/1aqJJJ

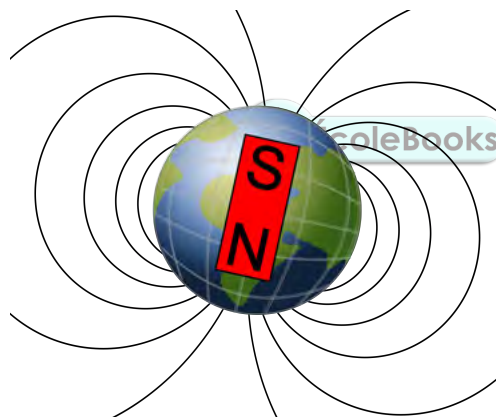

Earth has a magnetic field, as though there is a big bar magnet running through the core, with its South Pole under Earth's magnetic North pole.

TAKE NOTE

The Southern lights are also called the Aurora Australis and the Northern lights are called the Aurora Borealis.

The Earth's magnetic field is the reason why we can use compasses to tell direction.

A plotting compass has a needle with a small magnet. The needle points to magnetic north because the small magnet is attracted to the opposite magnetic field and can be used to determine direction.



A compass with the needle pointing North.

VISIT

What causes the Northern Lights? bit.ly/16PIN0x

VISIT

Magnetic liquid (video). bit.ly/190ixQY

Have you heard of the Southern or Northern Lights before? Do you know how this phenomenon occurs?

Charged particles escape from the surface of the Sun and move outwards in all directions. When the charged particles reach Earth, some are trapped by Earth's magnetic field in areas in space around Earth's atmosphere, called belts.

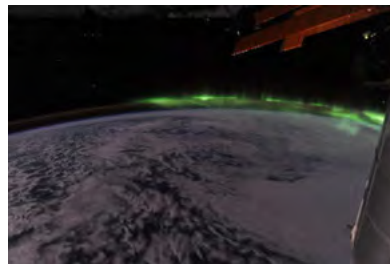

The Southern Lights, viewed from the International Space Station.

Sometimes the charged particles escape the belts and spiral along the magnetic field lines towards the magnetic poles where they enter Earth's atmosphere. They then interact with atmospheric gas particles, causing beautiful light shows.



An example of a ferrofluid, a liquid that can become magnetised in a magnetic field.

Some liquids can also become magnetised in the presence of a strong magnetic field. They are called ferrofluids.

Electrostatic forces

Do you remember learning about static electricity in Gr. 8? Let's do a quick activity to revise some of the concepts we already know.

TEACHER'S NOTE

Even though these experiments were done in Gr. 8, it is important for the learners to do them again as an activity. This will help them to understand how the electroscope and Van de Graaff generators work.

ACTIVITY: Charging objects

TEACHER'S NOTE

You can also do this activity using a plastic comb rather than balloons. Otherwise you can use pieces of paper instead of a learner's hair as not all hair will behave in the following way.



MATERIALS:

- balloons (or a plastic comb)
- glass rod
- piece of knitted fabric (wool)
- PVC rod
- plastic ruler
- small pieces of paper
- water tap

INSTRUCTIONS:

1. Work in pairs.
2. Blow up a balloon and tie it closed so the air does not escape.
3. Hold the balloon a short distance away from your hair. What do you notice?
Nothing happens.
4. Rub your hair with the balloon.
5. Now hold the balloon a short distance away from your hair. What do you see?
The hair should "rise" and stick to the balloon.
6. Next, hold the glass rod over the small pieces of paper. What do you notice?
Nothing happens.
7. Rub the glass rod with the knitted fabric.
8. Hold the glass rod over the pieces of paper. What do you notice?
The pieces of paper stick to the glass rod.
9. Rub the glass rod with the knitted fabric again.
10. Open the tap so that a thin stream of water is flowing.
11. Hold the glass rod close to the stream of water. What do you notice?
The stream of water bends towards the glass rod.

QUESTIONS:

1. What did you do to make your hair stick to the balloon?
Rubbed it vigorously with the balloon.
2. What happens when you rub the glass rod with the knitted fabric?
Electrons are transferred from the glass rod to the knitted fabric because of friction. The glass rod becomes positively charged and the wool becomes negatively charged.
3. Why did the glass rod attract the stream of water?
The water has positive and negative charges. The negative charges were attracted to the positively charged rod.

Let's look at the example of brushing your hair in more detail to understand what is happening. You have dragged the surface of the plastic comb against the surfaces of your hair. When two surfaces are rubbed together there is **friction** between them. The friction between two surfaces can cause electrons to be transferred from one surface to the other.

In order to understand how electrons can be transferred, we need to remember what we learnt about the structure of an atom.

Where are the electrons positioned in the atom?

TEACHER'S NOTE

The electrons are positioned in the space around the nucleus.

What is the type of charge on a proton?

TEACHER'S NOTE

Positive charge.

What is the type charge on an electron?

TEACHER'S NOTE

Negative charge.

What is the charge on a neutron?

TEACHER'S NOTE

Neutrons are not charged. They are neutral.



The atom is held together by the **electrostatic attraction** between the positively charged nucleus and the negatively charged electrons. Within an atom, the electrons closest to the nucleus are the most strongly held, whilst those further away experience a weaker attraction.

Normally, atoms contain the same number of protons and electrons. This means that atoms are normally **neutral** because they have the same number of positive and negative charges, so the charges balance each other out. All objects are made up of atoms and since atoms are normally neutral, objects are also usually neutral.

However, when we rub two surfaces together, like when you comb your hair or rub a balloon against your hair, the friction can cause electrons to be transferred from one object to another. Remember, the protons are fixed in place in the nucleus and so they cannot be transferred between atoms. Only electrons can be transferred between atoms. Some objects give up electrons more easily than other objects. Look at the following diagram which explains how this happens.

VISIT
Discover more online with a simulation on rubbing balloons and a jersey.
bit.ly/16ht6ff



Which object gave up some of its electrons in the diagram?

TEACHER'S NOTE

The hair.

Does this object now have more positive or more negative charges?

TEACHER'S NOTE

It has more positive charges.

Which object gained electrons in the diagram?

TEACHER'S NOTE

The comb.

Does this object now have more positive or more negative charges?

TEACHER'S NOTE

It has more negative charges.

When an object has more electrons than protons, we say that the object is **negatively charged**.

When an object has fewer electrons than protons, we say that the object is **positively charged**.

TAKE NOTE

Remember it is only the outer electrons which move, and not the protons which are located in the nucleus of the atom.

Have a look at the following diagrams which illustrate this.

6 positive charges and
6 negative charges
 $6 + (-6) = 0$

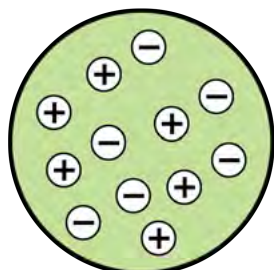

There is zero overall charge.
The object is neutral.

8 positive charges and
6 negative charges
 $8 + (-6) = 2$

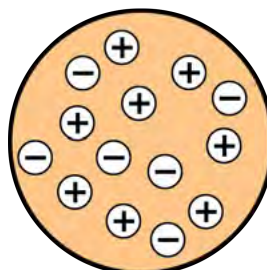

The overall charge is +2.
The object is positively charged.

6 positive charges and
9 negative charges
 $6 + (-9) = -3$

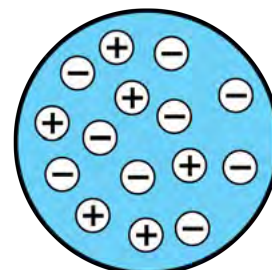

The overall charge is -3.
The object is negatively charged.

VISIT

A simulation on friction
between a carpet and John

Travolta's foot.

bit.ly/1bYsHpT

We now understand the transfer of electrons that takes place as a result of friction between objects. But how did that result in your hair rising when you brought the charged balloon close to your hair in the last activity? Let's look at what happens when oppositely charged objects are brought together.

ACTIVITY: Turning the wheel

TEACHER'S NOTE

This is a fun demonstration of how like charges repel each other and unlike charges attract each other. If you have enough materials, allow the learners to try this themselves. If you don't have enough materials, do this as a demonstration but give the learners a chance to play a bit.

Practice this activity a few times first to make sure that you have the method right. Remember that it is quite easy to accidentally earth the rods so work with care. This will work best on a dry day. This will be dependent on the area in which you live.

At a brainstorming workshop with volunteer teachers and academics at the beginning of 2013, we filmed a quick demonstration of this task when the group was discussing it. You can view this short clip here: ⁶ bit.ly/1fFbbbJ

MATERIALS:

- 2 curved watch glasses
- 2 perspex rods
- cloth: wool or nylon
- plastic rod
- small pieces of torn paper

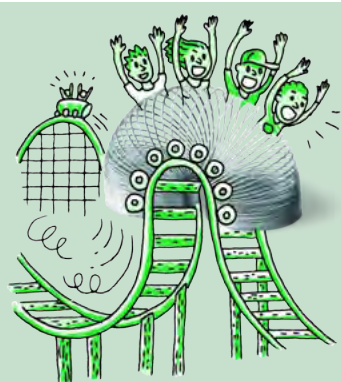

INSTRUCTIONS:

1. Place a watch glass upside down on the table.
2. Balance the second watch glass upright on the first watch glass.
3. Rub one of the perspex rods vigorously with the cloth.
4. Balance the perspex rod across the top of the watch glass.
5. Rub the second perspex rod vigorously with the same cloth.
6. Bring the second perspex rod close to the side of the first perspex rod that was charged. What do you see happening?



TEACHER'S NOTE

The second perspex rod should repel the first one as they have like charges, so learners should see the second rod 'pushing' the first one around in a circle.

You might need to rub the first perspex rod again, in between attempts, as the charge does dissipate.

7. Repeat the activity but instead of the second perspex rod, use the plastic rod. What do you see happening?

TEACHER'S NOTE

The rods now have opposite charges and so the second rod should be seen to 'pull' the other rod around in a circle.

8. Next, bring a rod that you have rubbed closer to small pieces of torn paper on the table. What do you observe?

TEACHER'S NOTE

The learners should be able to pick up the pieces of paper with the charged rod.

TAKE NOTE

Remember, **like charges repel** and **opposite charges attract**.

QUESTIONS:

1. What happened when you brought the second perspex rod close to the first perspex rod?

When the rods are the same (i.e. both perspex) then the first rod should move away from the second and the top watch glass will turn in a circle.

2. What happened when you brought the plastic rod close to the first perspex rod?

When the two different materials are used then the first rod should move towards the plastic rod and the watch glass will turn in a circle towards the plastic rod.

3. What happened when you brought the plastic rod close to the pieces of paper?

The pieces of paper were attracted to the rod.

When we rubbed the perspex rods with the cloth, electrons were transferred from the perspex to the cloth. What charge do the perspex rods now have?

TEACHER'S NOTE

A positive charge.

Both the perspex rods now have the **same** charge. Did you notice that objects with the same charge tend to push each other away? We say that they are **repelling** each other. It is an electrostatic force of repulsion.

When we rubbed the plastic rod with the cloth, electrons were transferred from the cloth to the plastic rod. What charge does the plastic rod now have?

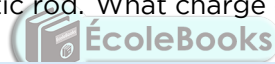

TEACHER'S NOTE

A negative charge.

The perspex rod and the plastic rod now have **opposite** charges. Did you notice that objects with different charges tend to pull each other together? We say that they are **attracting** each other. It is an electrostatic force of attraction.

As with gravitational and magnetic force, the distance between charged objects affects the strength of the electrostatic force. The closer the charged objects are, the stronger the force. The more charged the objects are, the stronger the electrostatic force between them.

We have now observed the fundamental behaviour of charges. In summary, we can say:

- If two negatively charged objects are brought close together, then they will repel each other.
- If two positively charged objects are brought close together, then they will repel each other.
- If a positively charged object is brought closer to a negatively charged object, they will attract each other.

Have you ever wondered where lightning comes from? Let's demonstrate an electrostatic spark.

VISIT

Opposites attract and like repel (video) bit.ly/174fSs9

VISIT

Big sparks, little sparks. bit.ly/1bYvJdy

ACTIVITY: Van de Graaff generator

TEACHER'S NOTE

This is an **optional, extension** activity. The Van de Graaff generator can be used for all sorts of fun activities. You can use it to explain various static electricity concepts. There are several websites with ideas and suggestions for fun activities and videos of demonstrations, such as this one: ⁷ bit.ly/19TuryU

The purpose of this activity is to show how sparks are made so that you can go on to explain how lightning works. If you do not have a Van de Graaff generator then use a video clip (such as this one⁸ bit.ly/1bYvJdy from the internet.

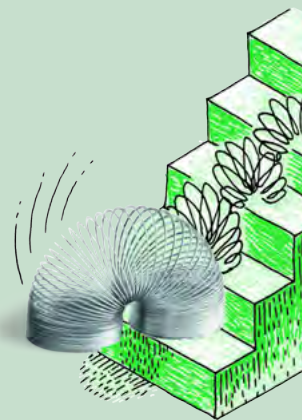

MATERIALS:

- Van de Graaff generator

INSTRUCTIONS

1. Turn on the generator.
2. Bring the small metal globe close to the generator. What do you see?
The learners should see a spark between the generator and the globe.



A Van de Graaff generator.

Did you see sparks? The Van de Graaff generator can be used to demonstrate the effects of an electrostatic charge. The big metal dome at the top becomes positively charged when the generator is turned on. When the dome is charged it can be discharged by bringing another insulated metal sphere close to the dome. The electrons will jump to the dome from the metal sphere and cause a spark.

How does this little spark relate to a massive lightning strike?



Lightning is a huge electrostatic discharge.

VISIT

How to survive a lightning strike. bit.ly/GS5BTm

During a lightning storm, clouds become charged. Friction between the clouds and the moisture in the clouds cause the clouds to become charged. The bottom of the clouds (closest to the ground) become negatively charged and the top of the cloud becomes positively charged. When the build-up of charge becomes too large, the electrons move from the bottom of the cloud to the ground where they are "earthed". The energy transfer is massive and results in extremely bright light, heat and sound. A lightning flash is a massive discharge between charged regions within clouds, or between clouds and the Earth. The thunder-clap, which we hear, is the air moving as a result of electrons moving.

Lightning is extremely dangerous. If the electrons move through a person on their way to the ground, then the large amounts of energy cause significant damage. That person can suffer serious injury, even death.

What precautions should we take during a lightning storm? Lightning can strike far from the rain shadow of the storm. This means that even if the storm seems to be far away, it is better to take precautions anyway. The safest place to be in a lightning storm is indoors. Stay away from windows and metal objects. If you cannot get inside, avoid standing next to tall objects or metal objects because if lightning strikes it will usually hit the tallest object in the area. If you are travelling in a car during a storm, stay inside the car until the storm subsides.

TEACHER'S NOTE

These workbooks were created by Siyavula with the help of contributors and volunteers. Read more about Siyavula here.⁹ www.siyavula.com

SUMMARY:

Key Concepts

- A force is defined as a push or a pull on an object.
- Forces are measured in newtons (N).
- A force can change the shape, direction and motion of an object.
- Forces act in pairs. The force acting on the object is called the action and the force that the object exerts back in the opposite direction and equal in magnitude is the reaction.
- More than one force can act on an object. The net or resultant force is the sum of all the forces acting on the object.
- The forces acting on a body can be represented as a free-body diagram where the arrows indicate the direction and magnitude of the different forces.
- There are two main groups of forces; contact and non-contact (field) forces.
- Contact forces act when objects are in contact (touching) with each other. Friction, tension and compression are examples of contact forces.
- Friction is the force opposing motion between two surfaces as they rub against each other.
- Compression forces are two forces acting on one object, moving in opposite directions (towards each other) to compress or deform the object.
- Tension forces are two forces acting on one object, moving in opposite directions (away from each other) to stretch the object.
- Non-contact forces can act over a distance and objects do not have to be touching each other. Common examples of field forces are magnetic, electrostatic and gravitational forces.
- Non-contact forces are known as field forces. A field is a region in space where a certain object with certain properties will experience a force.
- Gravitational force is a force of attraction between two bodies due to their mass. The gravitational force increases with mass and decreases with the distance between the bodies.
- The weight of a body is the gravitational force exerted on an object by the Earth (or Moon or other planet). The weight will vary depending on where it is measured.
- The mass of an object is a measure of how much matter it contains. The mass stays constant no matter where it is determined.
- Weight is calculated as $W = m \times g$, where g is the gravitational acceleration. On Earth, $g = 9,8\text{m/s}^2$.
- A magnet is a material which has a strong magnetic field around it.
- Magnetic forces of attraction exist between a magnet and a magnetic substance, such as iron, steel, cobalt and nickel.
- A magnet has two poles, a north and south pole. Opposite poles attract each other and like poles repel each other.
- The Earth has a magnetic field around it. We can use compasses to tell direction as the needle is a magnet which points to magnetic North.
- When certain materials are rubbed together, the friction between them causes electrons to move from one material to the other. The objects then have an electrostatic charge, due to either the loss or gain of electrons.



- A charge is a fundamental property of matter. Electrons carry negative charges and protons carry positive charges.
- An object which has gained electrons will be negatively charged. An object which has lost electrons will be positively charged.
- There is an electrostatic force of attraction between objects with opposite charges, and repulsion between objects with like charges.
- Thunder clouds can become charged as the water and air particles rub against each other. A lightning strike occurs when there is a huge discharge between the thunderclouds and the ground.
- Lightning is dangerous and safety precautions should be adhered to during lightning storms.

Concept Map

Complete the concept map to summarise what you have learnt about forces in this chapter. You can also use the space around the concept maps to add some of your own notes on these to help form more comprehensive summaries. This will help you prepare for exams when you need to revise everything from the year.



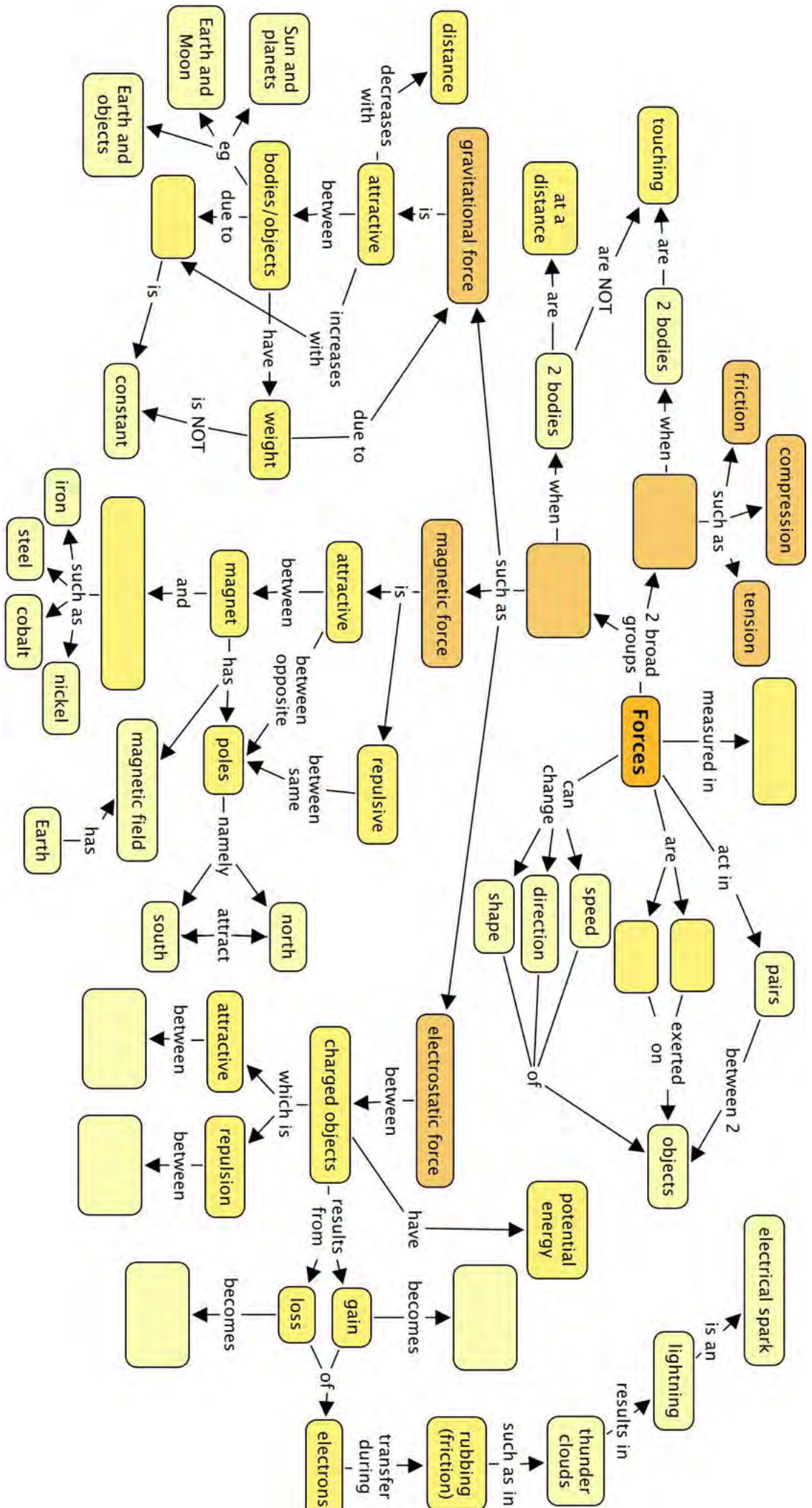

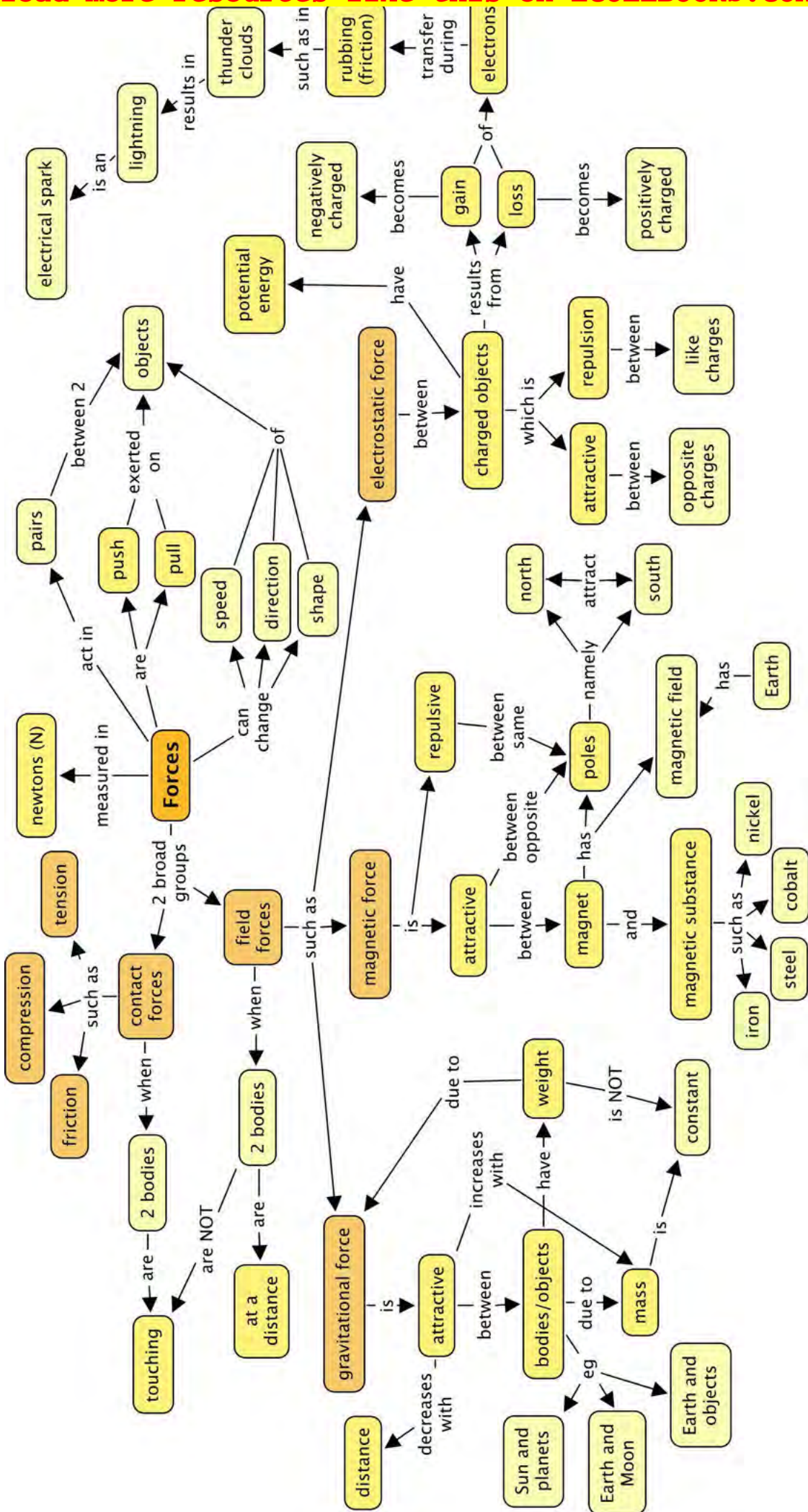

REVISION:

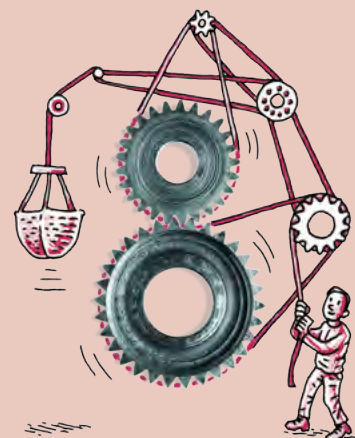

1. Give one term for each of the following descriptions. [5 marks]
 - a) An influence that can deform a flexible object or change the motion of an object with mass.
 - b) A region in space where an object with certain properties will experience a force.
 - c) When the only force acting on an object is the force due to gravity.
 - d) The two opposite ends of a magnet.
 - e) A fundamental property of matter that comes in two types and is carried by protons and electrons.

- a) *Force.*
- b) *Field.*
- c) *Free-fall*
- d) *Poles.*
- e) *Charge.*

2. Four possible answers are given for each of the following questions. There is only one correct answer. Write the letter on the line below each question. [6 x 2 = 12 marks]

- a) Which ONE of the following statements is FALSE?
 - A.** In order for a non-moving object to start moving, a net force must act on that object.
 - B.** Contact forces are strongest when the objects experiencing the force are touching.
 - C.** Field forces act over distances, but they can also act when objects are touching.
 - D.** Forces always act in pairs of equal strength, but these pairs act on different objects.
- b) Which ONE of the following is NOT a field force?
 - A.** Gravitational force
 - B.** Frictional force
 - C.** Electrostatic force
 - D.** Magnetic force
- c) The correct unit for gravitational force is:
 - A.** the newton
 - B.** the kilogram
 - C.** the newton per kilogram
 - D.** the kilogram per newton
- d) Which ONE of the following substances is magnetic?
 - A.** aluminium
 - B.** copper
 - C.** cobalt
 - D.** tin

- e) The electrostatic force between two charged objects is F . The distance between them is increased. How does the electrostatic force change?
- It increases
 - It decreases
 - It remains the same
 - Not enough information has been provided.
- f) An astronaut has a mass of 80 kg on Earth. Which ONE of the following regarding mass and weight of the astronaut on the Moon is correct?
- The mass will be the same and the weight will also be the same.
 - The mass will be less and the weight will also be less.
 - The mass will be the same and the weight will be less.
 - The mass will be less and the weight will be the same.

- a) B
 b) B
 c) A
 d) C
 e) B
 f) C

Decide which of the following statements are True or False. If they are False, rewrite them to make them true. [5 x 2 = 10 marks]

3. a) A force cannot make a motionless object move.
 b) A force can make a moving object change direction.
 c) A force can change the shape of an object.
 d) A tension force slows down or stops an object because of the surfaces rubbing against each other.
 e) Lightning is an application of a magnetic force.

- a) *False. A force can make a motionless object move.*
 b) *True*
 c) *True*
 d) *False. A friction force slows down or stops an object because of the surfaces rubbing against each other*
 e) *False. Lightning is an application of an electrostatic force.*

Have a look at the following images.

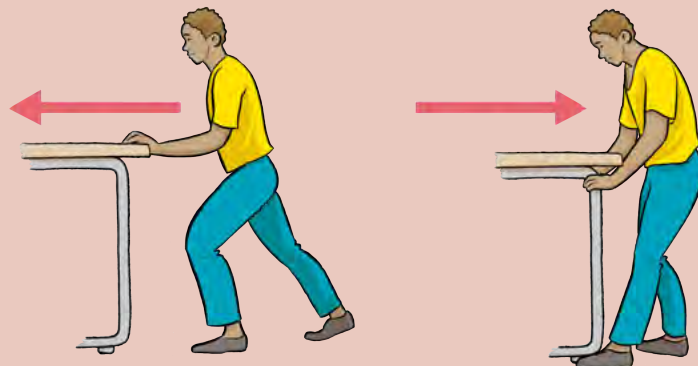

4.

- Which situation shows a push and which situation shows a pull? [1 mark]
- The boy is pulling the desk with a force of 70 N. There is a frictional force of 20 N. Draw a free body diagram in the space below to show these forces acting on the desk. [4 marks]
- What is the net force acting on the desk? [1 mark]

- The image on the left shows a push and on the right shows a pull.
- 1 mark is allocated to drawing a dot for the desk.
1 mark is allocated for the correct values used.
2 marks are allocated to the correct direction of the arrows and the arrow lengths to show the difference in magnitude of the forces.



50 N to the right.

A force of 50 N and 80 N act on a block. Calculate the net force acting on the block if:

- the forces are acting in the same direction [1 mark]
 - the forces are acting in opposite directions [1 mark]
 - 110 N*
 - 30 N*
- Write down three different effects that a force can have on an object. [3 marks]
 - change in motion (faster or slower)*
 - change in direction*
 - change in shape*
- What is the following diagram illustrating? Explain your answer. [4 marks]

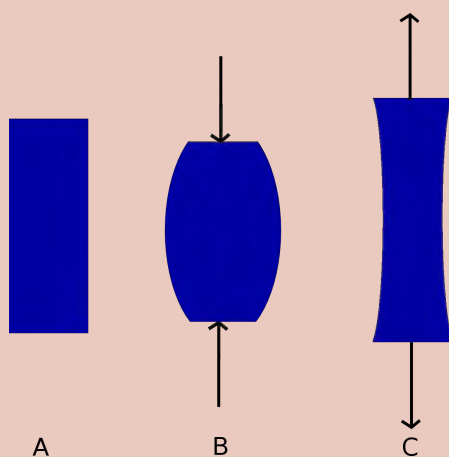

Image A shows the object at rest and image B and C shows the object with different forces applied to it. Image B shows compression forces applied to compress the object. Image C shows tension forces applied to stretch the object.

8. Tabulate the distinction between mass and weight by making use of definitions of mass and weight and comparing the units they are measured in. [5 marks]

Table showing the difference between mass and weight.

	Mass	Weight
<i>Definition</i>	<i>Mass is determined by the amount of matter that an object is made up of, and it remains constant no matter where it is measured.</i>	<i>The weight of an object is determined by the gravitational force exerted on it by the Earth or other large object, such as the Moon or another planet. The weight varies depending on where it is determined and the strength of the gravitational force.</i>
<i>Units</i>	<i>kilograms (kg)</i>	<i>newtons (N)</i>

9. Write down the formula that relates the weight of an object to its mass. Explain what each symbol represents. [4 marks]

$W = m \times g$, where W is the weight of the object in N, m is the mass of the object in kg and g is the gravitational acceleration in m/s^2 .

10. What TWO factors affect the gravitational force experienced between two objects? Explain the relationship. [2 marks]

The distance between the objects, as the closer they are, the stronger the force, and the mass of the objects as the greater the mass, the stronger the force.

11. An astronaut performs an experiment to determine the relationship between mass and weight on different planets. He takes a scale and sets off in a spaceship and measures his own weight on different planets in the solar system. The following table indicates his results.

Planet	Weight (N)
Mercury	287
Venus	710
Earth	?
Mars	302
Jupiter	2076
Saturn	886
Uranus	854
Neptune	1126

- a) Calculate the astronaut's weight on Earth if his mass is 80 kg. [3 marks]
- b) Plot an appropriate graph of the astronaut's weight on different planets of the solar system. Your graph will need a suitable heading and labels for the axes. [8 marks]
- c) On which planet is Kevin's weight the smallest? What does this tell you about the size of this planet in relation to the other planets? [2 marks]
- a) *Learners must provide the formula, then substitute with the values and provide the answer with the units.*
- $$W = m \times g$$
- $$= 80 \times 9,8$$
- $$= 784 \text{ N}$$
- b) *Learners must draw a bar graph with gaps between the bars [2 marks], provide a heading [1 mark], x-axis label [1 mark], y-axis label with units [1 mark], appropriate vertical scale [1 mark], accuracy of plotting [2 marks].*
- c) *His weight is the smallest on Mercury as Mercury is the smallest planet in mass.*
12. Draw a diagram to illustrate the magnetic field around a bar magnet. [3 marks]

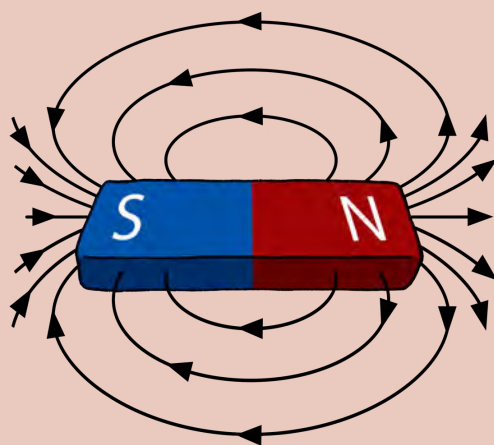

13. You do an experiment in class to investigate the bar magnets. You place two magnets next to each other on the table and place a sheet of paper over the magnets and sprinkle iron filings over the paper. You then turn one magnet around and do it again. You see the following patterns. What does each photo (A and B) show us? [2 marks]

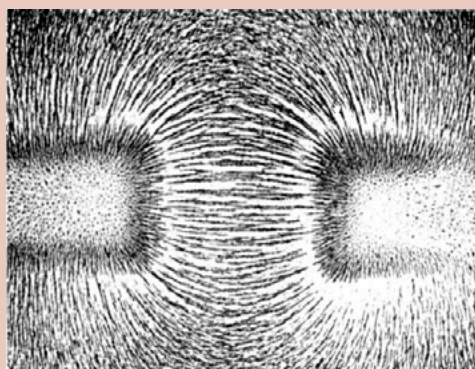

Photo A.

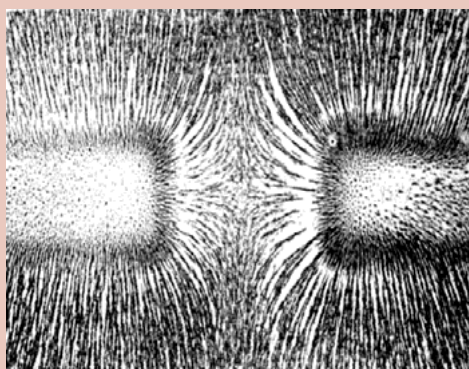
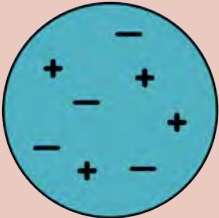
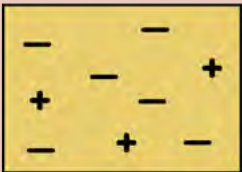
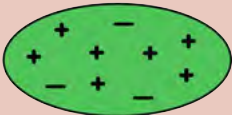

Photo B.

Photo A shows the magnetic field between two opposite poles which are attracting each other. Photo B shows the magnetic field between two like poles (either north and north or south and south) which are repelling each other.

14. Complete the table by determining the overall charge on each object. Show your calculations. State whether the object is positively charged, negatively charged or neutral and why. [9 marks]

3 marks for each of the objects, 1 mark is awarded to the calculation and 2 marks to the explanation.

Object	Overall charge	Why is it positive, negative or neutral?
	$Charge = 4 + (-4) = 0$	<i>It is neutral as there are equal numbers of positive and negative charges.</i>
	$Charge = 3 + (-6) = -3$	<i>It is negatively charged as there are 3 more negative than positive charges.</i>
	$Charge = 7 + (-3) = 4$	<i>It is positively charged as there are 4 more positive charges than negative charges.</i>

15. A balloon is rubbed against a jersey and the balloon picks up a negative charge.

- Explain where this negative charge comes from. Make reference to both protons and electrons in your answer. [3 marks]
- Name the type of force that the balloon and jersey will experience DURING rubbing. [1 mark]
- Name the type of force that the balloon and jersey will experience AFTER rubbing. [1 mark]
- Will the force referred to in (c) be attractive or repulsive? [1 mark]

- Electrons are transferred from the jersey to the balloon. Protons are not transferred. Electrons are negatively charged and thus the balloon picks up a negative charge.*
- Friction.*
- Electrostatic force.*
- Attractive.*

16. What do you think these two girls are touching on the left of the photo? Explain your answer and what is happening to them. [3 marks]



What is happening in this photo?

The girls are touching the hollow dome of a Van de Graaff generator. The dome is positively charged so electrons are transferred from their bodies to the dome to discharge it. This causes their bodies and hair to become positively charged. Their hair strands now repel each other as they are all positive (like charges repel) and they rise up.

17. Write a short paragraph to explain how lightning forms. [4 marks]
Friction between the water and air particles in the clouds causes a build-up of negative charge. When there is a large excess charge in the clouds, the excess charge moves through the air to the ground and discharges. This discharge forms a bright spark as the energy which is released by the moving charges is in the form of heat, light and sound. This is lightning.
18. What is wrong with the following scene? Explain your answer. [2 marks]



The learners are playing outside during a lightning storm, which is dangerous. Furthermore, they are underneath a tree, which is even more dangerous as the lightning strikes tall objects, such as trees, and so they are at risk of getting shocked.

Total [94 marks]



TEACHER'S NOTE

Chapter overview

0.5 weeks

This is a very short chapter with only 1.5 hours of teaching time allocated to it. We revisit the idea of a system and energy transfers within a system focusing on electric cells. The concept of a system, looking at potential and kinetic energy and conservation of energy within a system, was first introduced in Gr 7 Energy and Change. In Gr 8 Energy and Change, learners would have also looked at energy transfers within an electrical system. The focus of this chapter however, is on electric cells.

We will start off by looking at a simple electric cell made using an acidic fruit to explain what happens within a cell in an electric cell, and then we will make a more complex electric cell using copper and zinc plates as electrodes. It is important to make the distinction between a cell and a battery as these words are often used interchangeably. A battery is two or more cells that are connected together.

2.1 Electric cells (1.5 hours)

Tasks	Skills	Recommendation
Activity: Fruit cell	Following instructions, observing, analysing, explaining	CAPS suggested
Activity: Zinc-copper cell	Following instructions, observing, taking measurements, analysing, explaining	CAPS suggested



KEY QUESTIONS:

- Where does an electric circuit get its energy from?
- What is inside a battery?
- How can we build our own electric cells?
- How does an electric cell supply energy?

This term we will be investigating electricity and electric circuits in more detail. We are going to pay attention to electric cells. You have already come across electric cells in previous grades when looking at electric circuits. What is the circuit symbol for an electric cell? Draw it in the space below. Indicate the positive and negative terminal.



TEACHER'S NOTE

The symbol for an electric cell:

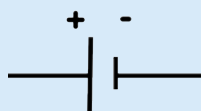

2.1 Electric cells

What is the source of energy in an electric circuit?

TEACHER'S NOTE

An electric cell.

We use electric cells to supply the energy needed for electrons to move around an electric circuit. We often talk about batteries in electric circuits or appliances. A battery is a group of two or more electric cells that are connected together. Where does the energy in a cell come from?

In Gr 8 we spoke about the transfer of energy within electrical systems. We can also call an electric cell a system. Write your own definition of a system below.

TEACHER'S NOTE

A system is a set of parts working together as a whole.

The electric cell system works to generate electricity. We have spoken before about how electricity is generated using moving parts, such as in a power station where the moving parts in a generator produce electricity. A cell does not have moving parts to generate electricity. An electric cell generates electricity from **chemical reactions**.

Did you know that we can create our own cell using a fruit? Let's try this out in the next activity.

TAKE NOTE

Last term in Matter and Materials we looked at many different types of chemical reactions.

ACTIVITY: Fruit cell

MATERIALS:

- lemon (or potato)
- zinc strip or galvanised nail
- copper strip or coin
- LED bulb
- ammeter
- insulated copper conducting wires



TEACHER'S NOTE

The citric acid in the lemon acts as an electrolyte. When two different metal electrodes are placed into the acidic lemon solution, and the circuit is closed, electrons flow from the one electrode to the other. This flow of electrons is called electric current.

This is a fun activity for the learners and easily accessible if you do not have the equipment to make the zinc/copper cell in the next activity.

The ammeter is optional. You can use the LED light instead of an ammeter to indicate that current is present. However, depending on the fruit that you use, the current might not be strong enough to make the LED light glow, and therefore an ammeter is a more sensitive measure of whether there is current. Connect several of the learner's fruit cells in series until the LED bulb lights up. Note that incandescent light bulbs from torches are not used as the lemon battery will not produce a high enough potential difference to light them up. Instead of a copper nail or copper strip, you can also use a copper coin or piece of copper wire. Instead of a zinc nail, you can also use a steel or iron nail. It is important to highlight to learners that TWO different conductors/metals must be used in the cell. If two of the same metals are used, a potential difference is not created, and the electrons will not flow. As an extension, you can also use different types of fruit to see which ones produce the best cells.

VISIT

Watch this video to understand how a lemon battery works.
bit.ly/16N076B

INSTRUCTIONS:

1. Gently squeeze the lemon to soften the fruit so that the juice is released inside. Be careful not to crush the lemon or break the peel. If you are using a potato, you do not need to squeeze it first.
2. Next, puncture the peel of the lemon with the two different nails (or strips) of **different** metals. If you are using a copper coin, then push it carefully into the lemon so that it breaks the skin.
3. Insert each nail slowly and carefully into either side of the lemon. Push the nails into the lemon so that they almost reach the centre of the lemon, but are not touching.
4. Attach one wire to the zinc (or iron) nail and the other wire to the copper nail or copper coin.
5. Connect the wires to the LED bulb and ammeter if you are using one as shown in the diagram.

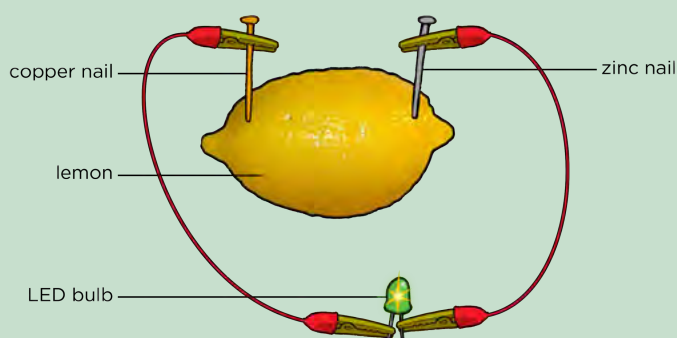

What do you notice?

There should be a small reading on the ammeter and the light bulb might glow. The size of the reading will depend on the size of the lemon and the quality of the connections. Make sure that the zinc and copper are not touching each other inside the lemon.

6. If your light bulb does not glow, connect your fruit cell with your partner's cell and reconnect the LED light bulb. Does it glow now? If not, connect several more fruit cells in a series until the LED bulb glows as shown in the diagram.

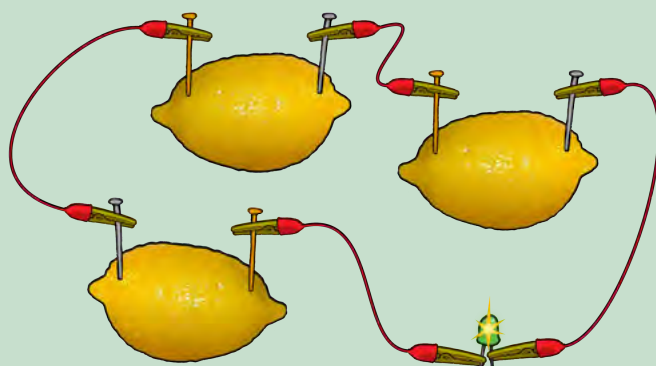

How many cells did you connect in series to cause the LED to emit light?

Learner-dependent answer.

7. What do we call the cells connected together?
A battery.
8. What happens if you replace the copper nail with another zinc nail, so that you have two electrodes of the **same** metal? Are you able to light up the LED light?

No you are not able to light up the LED bulb using two nails of the same type of metal. If two of the same metals are used, a potential difference is not created, and the electrons will not flow.

9. Experiment further by investigating the effects of pushing the nails deeper into the lemon and placing them at different positions in the lemon (closer together and further apart). Record some of your observations here.

Learners should see that the further the nails are pushed into the lemon, the greater the current. This is because the length of the electrodes exposed to the electrolyte is greater (there is increased surface area in contact with the electrolyte).

Placing the nails in different positions also has an effect, as the closer the electrodes are to each other, the less resistance there is, and therefore a greater current.

This is a good opportunity to also discuss a fair test as learners must only change one variable at a time.

A further extension is to use different electrodes. For example, replace the zinc nail or strip with a magnesium strip. Learners can then observe and compare the ammeter readings and draw further conclusions about how the type of material of the conductor has an effect.

TAKE NOTE

An electrolyte is a special type of solution which is able to conduct electricity.

In the last activity we created a simple electric battery. A chemical reaction takes place inside the lemon which produces electricity. The components in the lemon battery are very similar to those used in a normal battery. The copper and zinc nails (or strips of metal) are called **electrodes**. The lemon juice acts as the **electrolyte**. Citrus fruits, such as lemons, are acidic, which helps their juice to conduct electricity.

TAKE NOTE

The batteries that you might be most familiar with are the '1.5 V batteries'. These are actually single cells, and are therefore technically not batteries.

When the electrodes are connected in a circuit, a chemical reaction takes place within the electrolyte in the lemon which causes electrons to move in the external circuit. This flow of charge is **electric current**. The chemical reaction causes a potential difference which causes the flow of electrons in the external circuit. This will only occur when the cell is connected in a circuit. Think of a normal battery that you might use in a torch. You can store this battery for a long time, and it will not go flat as the chemical reactions only take place when it is connected in a circuit.

We are now going to build a more complex cell.

**ACTIVITY:** Zinc-copper cell**MATERIALS:**

- two 250 ml beakers
- copper sulphate solution
- zinc sulphate solution
- concentrated sodium sulphate or sodium chloride solution
- salt bridge made with a U tube (this can be made from a plastic tube which is bent) or filter paper soaked in the salt bridge solution
- cotton wool
- copper electrode
- zinc electrode
- insulated copper connecting wires with crocodile clips
- LED bulb
- ammeter

VISIT

Discover how a car battery works. bit.ly/H6ixWa

TEACHER'S NOTE

Prepare 1 M zinc sulphate and 1 M copper sulphate solutions before hand. A 1 molar (M) solution contains 1 mole of solute dissolved in 1 litre of solution:

- To make a 1 M solution of copper sulphate, dissolve 250 g of hydrated copper sulphate ($\text{CuSO}_4 \cdot 5\text{H}_2\text{O}$) in distilled water and then add more water until you have 1 litre.
- To make a 1 M solution of zinc sulphate, dissolve 288g of hydrated zinc sulphate ($\text{ZnSO}_4 \cdot 7\text{H}_2\text{O}$) in distilled water and then add more water until you have 1 litre

The exact concentration of sodium sulphate or sodium chloride is not too important.

If you have a sensitive measuring balance, measure the mass of the electrodes before the experiment, and then again one day later, to show the change in mass. This will highlight the fact that a chemical reaction has taken place.

If your solutions are concentrated enough, the bulb should glow, otherwise you can also connect more than one cell in series as was done with the lemons.

If you do not have enough materials for each learner to build a cell, you can do this as a demonstration or else set up a couple workstations for a group of learners to observe.

INSTRUCTIONS:

TEACHER'S NOTE

If you have a sensitive measuring balance, measure the mass of the copper and zinc plates and get learners to record this.

1. Pour about 200 ml of the zinc sulphate solution into a beaker and put the zinc electrode into the solution.
2. Pour about 200 ml of the copper sulphate solution into the second beaker and place the copper electrode into the solution.
3. Fill the U-tube with the sodium sulphate solution and seal the ends of the tubes with the cotton wool. This will stop the solution from flowing out when the U-tube is turned upside down.

Learners should fill the salt bridge with the sodium sulphate solution and then plug the ends with cotton wool. Inserting the salt bridge can be a difficult manoeuvre so make sure that they practise it a bit first and use enough cotton wool. If you do not have a U-bend tube then use strips of filter paper or a cloth soaked with saturated sodium sulphate solution.

4. Connect the zinc and copper electrodes to the ammeter. Does the ammeter record a reading?
No, there is no reading on the ammeter.
5. Place the U-tube so that one end is in the copper sulphate solution and the other end is in the zinc sulphate solution, as shown in the diagram.

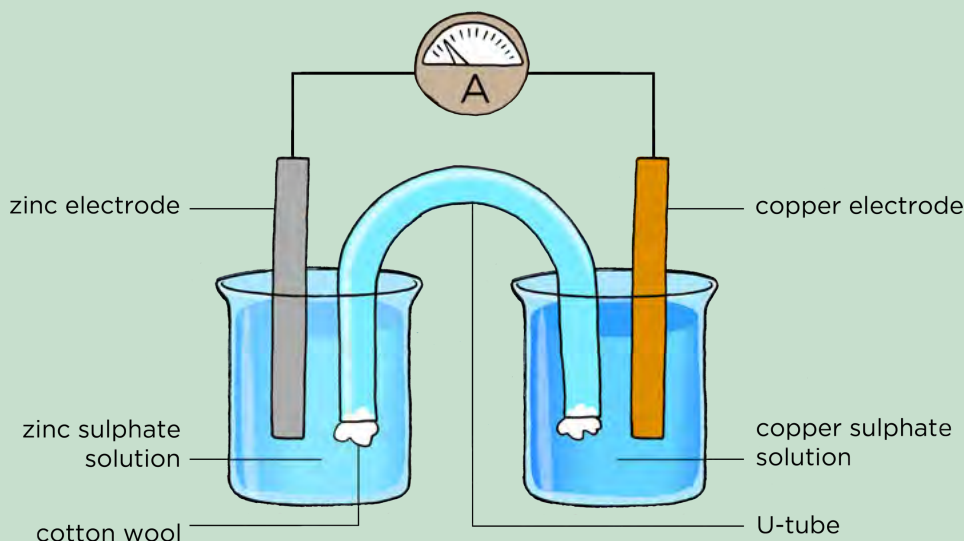

Is there a reading on the ammeter?

Yes, there is a reading on the ammeter.

6. Remove the ammeter and insert the LED bulb in the circuit. Does it glow? If not, try connecting a few cells in series until the LED lights up.
7. Observe what is happening at the copper electrode and at the zinc electrode.

TAKE NOTE

If you do not have a U-tube or plastic tubing, you can use strips of filter paper or a cloth soaked in the sodium sulfate solution with the ends dipped into each beaker.

TAKE NOTE

You can also use a voltmeter to measure the potential difference across the cell. The voltmeter will replace the ammeter and LED light.

TEACHER'S NOTE

If you measured the mass of the electrodes at the beginning of the experiment, take the ammeter away and connect the copper and zinc plates to each other directly using copper wire. Leave to stand for about one day.

After a day, remove the two plates and rinse them first with distilled water, then with alcohol and finally with ether. Dry the plates using a hair dryer.

Weigh the zinc and copper plates and get learners to record their mass again. Has the mass of the plates changed from the original measurements?

Yes, the mass should have changed. The mass of the zinc plate decreased, while the mass of the copper plate increased. Discuss this with your class. The changes in mass have occurred as chemical reactions have taken place in the solutions. This is discussed more in the text after the activity.

QUESTIONS:

1. What did you notice on the ammeter (or voltmeter) when you connected the circuit with the U-tube?

The ammeter should measure a current in the circuit. The voltmeter should register a potential difference across the two electrodes.

2. What does the ammeter reading tell us?

The ammeter reading tells us that there are electrons moving through the external circuit. There is a current.



In the last activity, we demonstrated a zinc-copper cell. This is made up of a zinc **half-cell** and a copper **half-cell**. Together, they make up the whole cell. The purpose of the U-tube is to connect the two half cells. It is called the **salt bridge**.

How do we explain the chemical reactions taking place in the zinc-copper cell?

When a zinc sulphate solution containing a zinc plate is connected by a U-tube to a copper sulphate solution containing a copper plate, reactions occur in both solutions.

- At the zinc electrode, the zinc metal has gone into the zinc sulphate solution as zinc ions.
- At the copper electrode, copper ions from the solution have deposited onto the electrode as copper metal atoms.

In the zinc-copper cell the important thing to notice is that the chemical reactions that take place at the two electrodes cause an electric current to flow through the outer circuit. In this type of cell, **chemical energy** is converted to **electrical energy**.

As we have said before, an electric battery used in appliances such as a torch consists of two or more electric cells connected together. There are many different battery cell types such as zinc-carbon, nickel-cadmium and nickel-zinc batteries.

VISIT

Read about a stretchy, gooey gadget that uses simple materials to conduct electricity and amplify sound. bit.ly/17tGzAQ

SUMMARY:

- An electric cell is a system in which chemical reactions take place to convert chemical energy into electrical energy.
- An acidic fruit can be used to construct a simple cell. The lemon juice acts as the electrolyte.
- An electric cell can be made using two beakers with an electrolyte and electrode in each. The electrolyte solutions in each half-cell are connected by a salt bridge.
- When the electrodes are connected to an external circuit, chemical reactions will take place in each of the beakers, causing a current in the external circuit.
- A battery is a group of cells which are connected together.
- There are many different types of batteries, such as zinc-carbon, nickel-cadmium and nickel-zinc batteries.

Concept map

This was a short chapter on electric cells, demonstrating how we can make cells. Use the following space to draw your own concept map summarising what was covered in this chapter. You can refer back to previous chapters and also concept maps from your A workbook when thinking about how to construct this concept map.



Electric cells as
energy systems

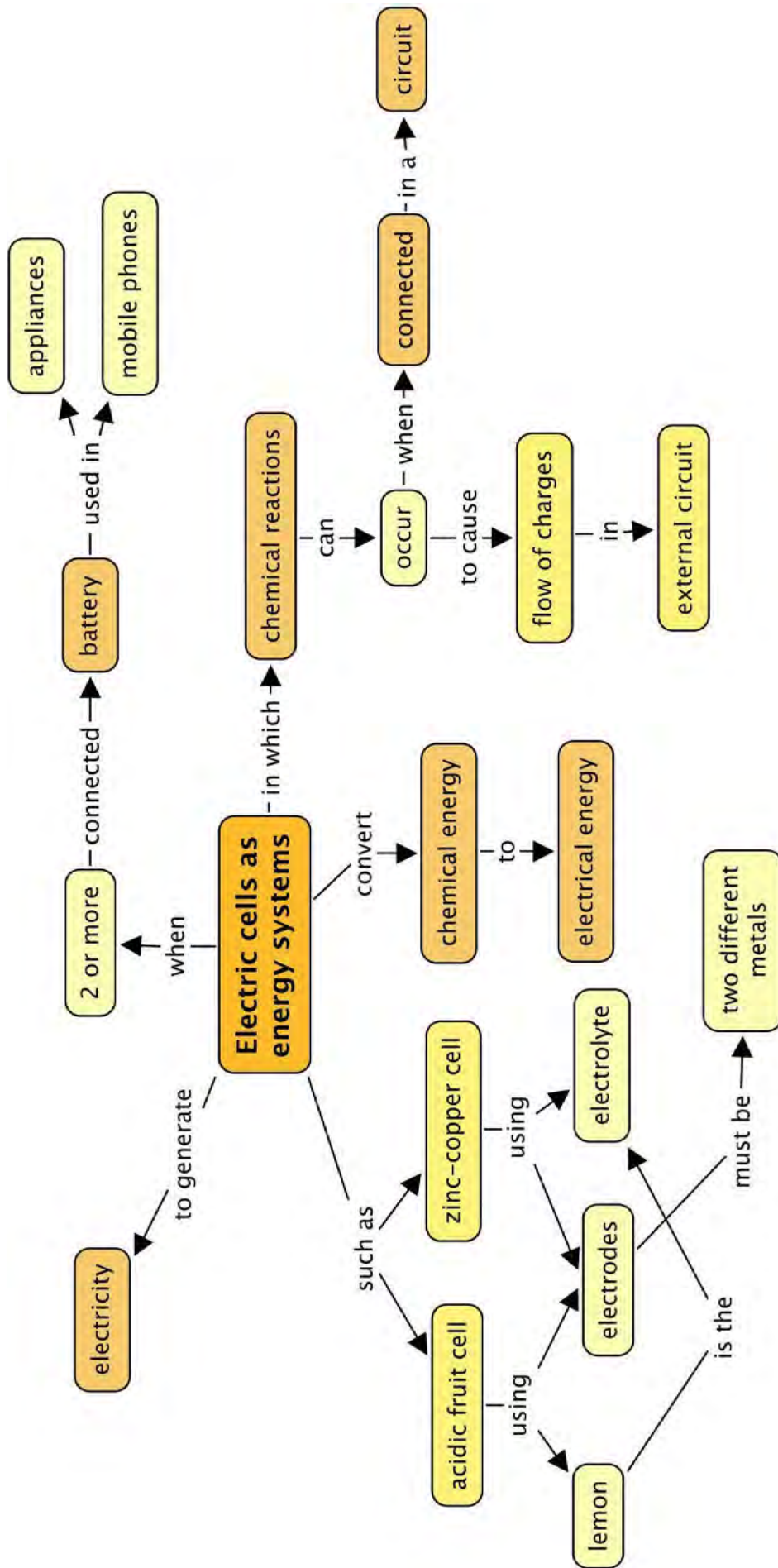

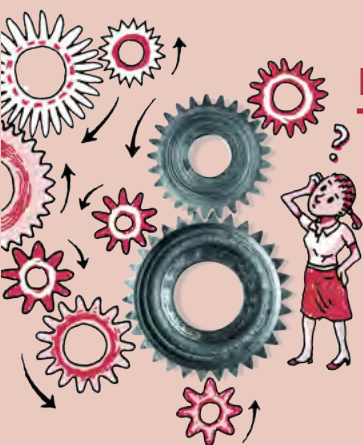

REVISION:

- Write a short paragraph to describe, in your own words, what an electrical cell is and how it causes a current in an external circuit. [3 marks]
The paragraph should mention that an electrical cell is a system in which chemical reactions occur. The chemical reactions set up a potential difference across the cell, which makes the electrons move around the circuit (electric current).
- What is the difference between a cell and a battery? [2 marks]
A cell is a system in which chemical reactions occur. A battery is a number of cells connected together.
- You made an electrical cell from a lemon. How could you generate enough energy from lemons in order to make a light bulb glow? [2 marks]
If you make several lemon cells and connect them in series with a light bulb.
- How would you test whether or not a battery or cell is producing energy? [2 marks]
You can connect an ammeter to measure current or use a torch light bulb. If the bulb glows then there is a current flowing. Or you can use a voltmeter to measure the potential difference.
- Draw a diagram to show how to set up a zinc-copper cell. Include an ammeter in the external circuit. You must use the following labels: zinc electrode, copper electrode, salt bridge/U-tube, zinc-sulphate solution, copper sulphate solution. [8 marks]
One mark is allocated to each of the correct labels, one mark to placing the salt bridge with the ends in each solution, one mark for including an ammeter in the correct position with the symbol A and one mark for placing the electrodes in the right solutions. A reference diagram is supplied here:

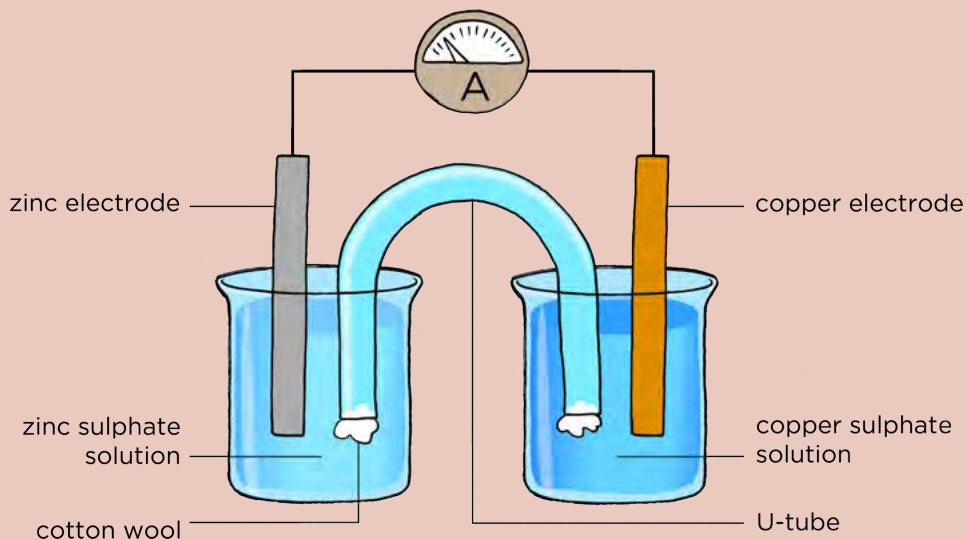

Total [17 marks]





TEACHER'S NOTE**Chapter overview**

1 week

This chapter starts off by explaining the meaning of resistance in an electric circuit. Learners will then look at the use of resistors. This is a revision of some of the concepts covered in Gr 8 Energy and Change when looking at the *Energy transfers within an electrical system* (Chapter 2). For an easy reference to what learners covered in the previous grade, you can visit the website www.curious.org.za where this content is located online, and navigate to the relevant grade and chapter.

This year, the concept of resistance will be extended by looking at the factors that affect resistance in a resistor, namely:

- the type of material of which the conductor is made
- the thickness of the conductor
- the length of the conductor
- the temperature of the conductor

These will be investigated experimentally. Learners must be able to explain the relationships between these factors and the resistance offered by the resistor. It is not necessary to show experimentally how temperature affects resistance, but the concept must still be covered. CAPS suggests investigating at least one of the other factors. All three investigations have been included in this workbook so that you have the choice as to which one you would like to conduct with your class, or, if time permits, you can conduct all three investigations. Three hours have been allocated to this section in CAPS, so you should have time to perform more than one of the investigations. In the workbook, they have been presented as three separate investigations, but you can also perform them concurrently, or allocate a different investigation to different groups. The groups can then report back to the class on their findings and you can subsequently summarise the effects on the board.

If you only teach Natural Sciences, it is a good idea to check with the Technology teachers to see how these two curriculums complement each other, especially with regard to electricity. Some of the concepts which might be introduced for the first time in Natural Sciences, have already been covered in the Technology curriculum. Knowing what learners have already covered and been introduced to will help make your classes more efficient and more stimulating for learners.

3.1 What is resistance?

This is included as an introduction.

3.2 Uses of resistors (1 hour)

Tasks	Skills	Recommendation
Activity: Useful resistance	Recalling, identifying, describing	Suggested
Activity: Make your own rheostat	Following instructions, predicting, observing, explaining	Optional
Activity: Comparing a LED to a filament light bulb	Describing, drawing, explaining, comparing	Suggested

3.3 Factors that affect resistance (2 hours)

Tasks	Skills	Recommendation
Investigation: How does the material of the resistor affect the resistance?	Hypothesising, identifying variables, following instructions, drawing, observing, describing, analysing, concluding	CAPS suggested
Investigation: How does the thickness of the conductor affect the resistance?	Hypothesising, identifying variables, following instructions, drawing, observing, describing, analysing, concluding	CAPS suggested
Investigation: How does the length of a conductor affect the resistance of the conductor?	Hypothesising, identifying variables, following instructions, drawing, observing, describing, analysing, concluding	CAPS suggested



KEY QUESTIONS:

- What is resistance?
- What do we use resistors for?
- Does length affect resistance?
- Does temperature affect resistance?
- Does the type of resistor material affect resistance?
- Does the thickness of a resistor affect the resistance?

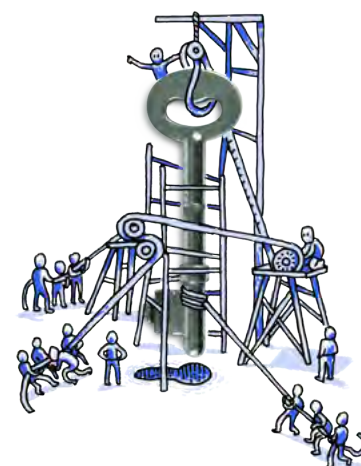

3.1 What is resistance?

TEACHER'S NOTE

A good way to introduce this topic is to act out the following situation with your learners which is explained in the learner's book. You can even just create an imaginary field by drawing a square with chalk on the ground and then a narrow corridor coming off of it. Tell learners to first walk around randomly in the field and then when you signal (indicating that a potential difference has been applied across the wire), they all need to move towards the corridor and get through it. You can make the corridor start off wide and become narrower to further illustrate how the resistance to their movement increases as the corridor becomes narrower. This only demonstrates one of the factors influencing resistance (namely the width of the conductor), but can be used to introduce the idea of resistance.

We have revised the concept of electric current and how electrons move within a conducting wire before introducing the idea of resistance in an electric circuit.

Think about your school break time. All of the learners are outside on the field, sitting in groups and relaxing. Some of you will be moving around the field from group to group as you greet your friends. The school bell rings, signaling the end of break. You all get up and start moving toward the school building. You are all able to move easily because there is a great deal of space but what happens as you enter the corridor of the school building?

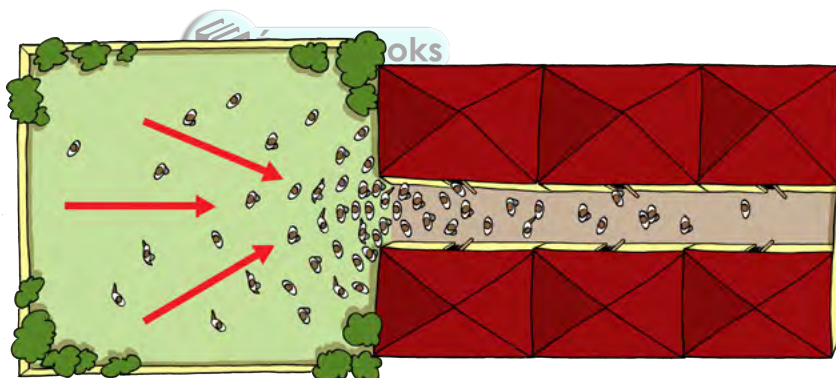

Everyone now has to fit through a narrow corridor. Everyone is trying to get to class and so some learners will bump into other learners. As you try to enter your classroom it becomes even more difficult because the doorway is even narrower than the corridor and so only one or two learners can pass through at a time.

The movement of the learners is very similar to the movement of electrons in an electrical conductor. The field offers a very low resistance to the movement of the learners and so the learners are able to move freely. The corridor has a higher resistance to the movement of the learners because less learners can now pass through the corridor than through the field. The classroom doorway offers the highest resistance as it only allows a few learners through at a time.

How can we use this to illustrate **electrical resistance**? Let's first revise some concepts about electric current.

An electric current is the rate of charge flow in a closed, electric circuit. The electrons in an atom are arranged in the outer space around the central nucleus. In metals, the electrons are able to move freely within the metal. The electrons are not associated with a particular atom in the metal. We say electrons in a metal are **delocalised**. Have a look at the following diagram which shows this.

TAKE NOTE
We can think of the model of a metal as the positive metal ions in fixed positions surrounded by a 'sea' of electrons.

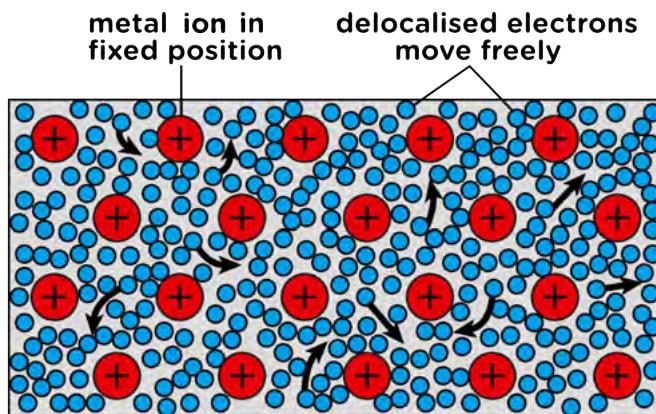

Conducting wire in an electric circuit is made of metal. If we supply it with a source of energy and a complete circuit, then the electrons will all move in the same general direction through the wire to the positive terminal of the battery. This movement of electrons per time through a conductor is the **electric current**.

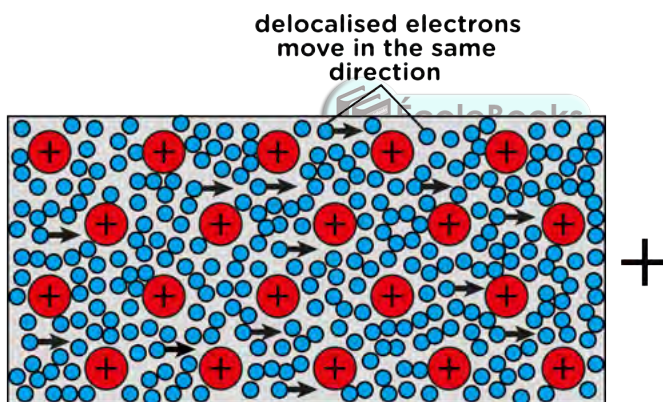

TAKE NOTE
Electric charge, or charge, is the physical property of matter that causes it to experience a force when close to other electrically charged matter. There are two types of electric charges - positive and negative. Electrons have a negative charge and protons have a positive charge.

Resistance in an electrical circuit opposes the passage of electrons. The unit of measurement for resistance is the **ohm**, with the symbol Ω .

Do you remember what an electrical conductor is? Write your own definition below.

TEACHER'S NOTE

An electrical conductor is a type of material or object which allows electric charge to pass through it.

You can also remind learners at this point that electrical insulators are non-conductors as they do not allow electric charge through them.

All electrical conductors have some resistance. Some conducting materials have a particular resistance and are used to add electrical resistance to a circuit. An electrical component which adds resistance to a circuit is called a **resistor**.



Different types of resistors used to add resistance to an electric circuit.

TAKE NOTE

Can you see that there are different coloured bands on the resistors? This isn't just to make them look pleasing to the eye. The coloured bands are actually a code that tells us the strength of the resistance of the resistor.

Resistors are electrical components and have a symbol to represent them in an electric circuit diagram. Do you remember the symbol from Gr 8? Draw it in the space below.

TEACHER'S NOTE

There are two symbols used to represent resistors, but the one most commonly used is the one using a block.

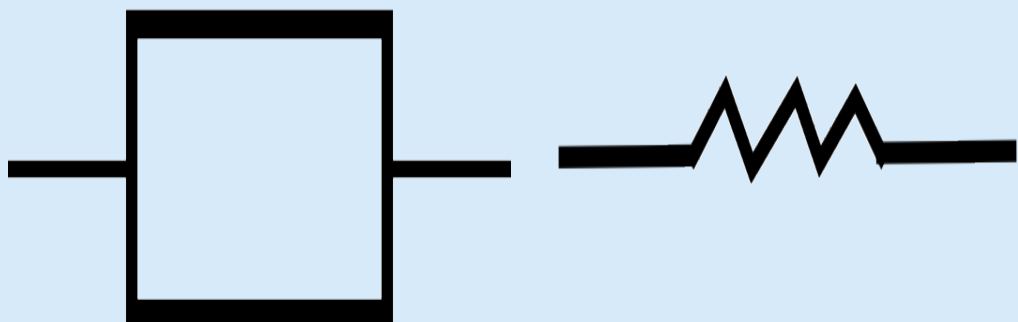

On a microscopic level, electrons moving through the conductor collide (or interact) with the particles of which the conductor (metal) is made. When they collide, they transfer kinetic energy. This leads to resistance. The transferred energy causes the resistor to heat up. You can feel this directly if you touch a cellphone charger when you are charging a cell phone - the charger gets warm because its circuits have some resistors in them.

3.2 Uses of resistors

Resistors can be used to control the current in a circuit. Think back to some of the work that you did in Gr 8. If you increase the resistance in a circuit, what happens to the current? Explain your answer.

TEACHER'S NOTE

Discuss this with your class as they might not have conducted these investigations in the previous grade. When the resistance in a circuit increases, the current decreases. Adding more resistance increases the opposition to the flow of charge so it is more difficult for charge to move through the circuit. Therefore there is less current (as current is the rate of flow of charge). We say that the current is inversely proportional to the resistance, meaning as the resistance increases, the current decreases.

Another way in which we can use resistors is to provide useful energy transfers. Do you remember looking at energy transfers in a system in Gr 8? The **input energy** enters the system and then provides an **output energy**. Some of the output energy is useful to us, and some is wasted energy. For example, a resistor can be used to transfer electrical energy into light (light bulb) or into heat (kettle element). Energy is wasted as it is lost to the surroundings. Resistors are used to provide useful energy transfers.

ACTIVITY: Useful resistance

TEACHER'S NOTE

This activity links back to the work done in Grade 8 Energy and Change. The difference between "useful" and "wasted" energy is highlighted again. The learners should see that resistors can be used to provide useful energy transfers.

Why do we want to resist the movement of electrons? Resistors can be extremely useful. Think about a kettle. If you look inside you will see a large metal coil.



Looking inside a kettle.

This metal coil is the heating element. If you plug in and switch on the kettle, the element heats up and heats the water. The element is a large resistor. When the electrons move through the resistor, they release a lot of energy in overcoming the resistance. This energy is transferred to the water in the form of heat. This transfer of energy is useful to us as the thermal energy is used to boil water in the kettle.

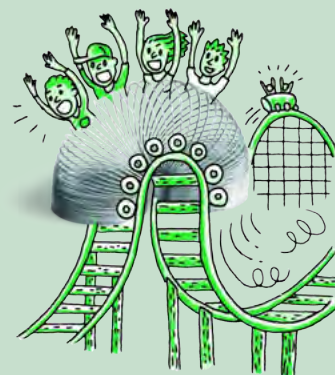

1. What is the input energy in this system?
Electrical energy.
2. What is the useful output energy?
Thermal energy.

Look at the photograph of a light bulb on the left. Can you see there is a small coiled wire in the glass bulb? This is called the filament. The filament is made from tungsten wire. This is an element with high resistance.



An incandescent light bulb.



The tungsten filament glowing brightly.

TAKE NOTE

Incandescent means to emit light as a result of being heated.

1. When the electrons move through the filament they experience high resistance. This means that they transfer a lot of their energy to the filament when they pass through. Describe the energy transfer taking place.
Electrical energy is transferred to heat and light.
2. What is the useful energy output and what is the wasted energy output in this light bulb?
Light is the useful output energy and heat is the wasted output energy.
3. The filament is tightly coiled. Why do you think this is? Discuss this with your class and teacher.
This is an extension question as learners will only cover factors affecting resistance later so discuss this as a class.
This is to fit a longer length of tungsten within a small space to increase the resistance.

Look at the following photo of a toaster.



An electric toaster.

4. Can you see the glowing filament inside? Why does the element glow?
The electric current passes through the toaster and the element has a high resistance. Energy is transferred to the particles in the element so that they

gain kinetic energy and the temperature of the wire increases. Some of the energy is also transferred as light to the surroundings and the wire glows.

5. What is the useful output energy in this system?

Heat.

6. What is the wasted output energy in this system?

Light.



Rheostats are another form of resistor which are commonly used. A **rheostat** is a device which is able to offer a **variable** resistance. Rheostats are used in electric circuits where you want to adjust the current, for example in sound equipment to adjust the volume, in dimmer switches for lights and in controlling the speed of **motors**. Let's look at how rheostats can be used in a circuit.

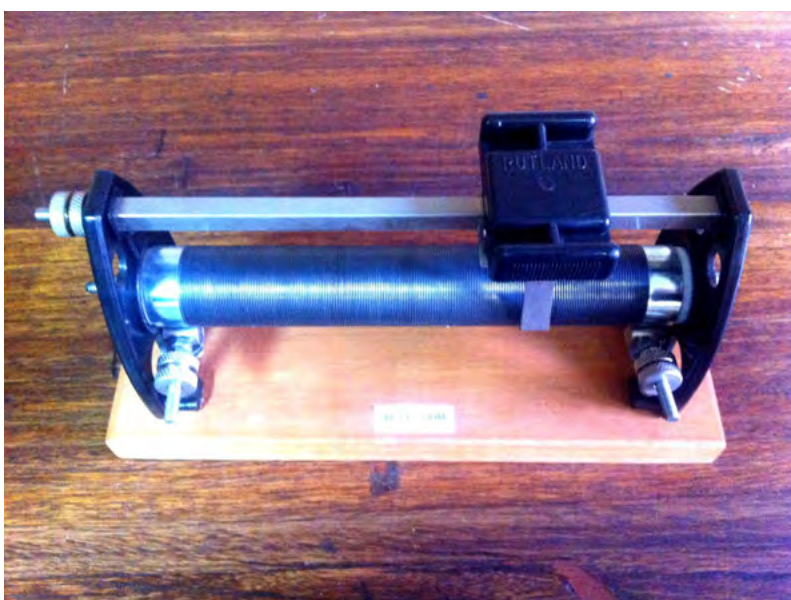

An example of a rheostat.

VISIT

The rheostat (video).

bit.ly/190xkLB

ACTIVITY: Make your own rheostat

TEACHER'S NOTE

If you have rheostats in your laboratory then you may choose to simply demonstrate how the resistance is varied by changing the position of the slider. The position of the slider affects the length of the resistor coil. Because length is a factor which affects resistance, the shorter the coil, the less resistance; the longer the coil, the greater the resistance.

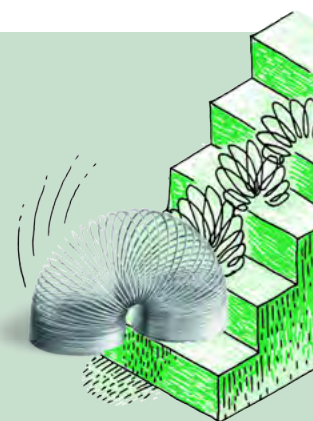

MATERIALS:

- graphite rod or graphite pencil
- torch light bulb
- battery (AA)
- insulated copper conducting wires with crocodile clips
- ammeter

TEACHER'S NOTE

If you do not have a graphite rod then a graphite pencil can be used. Sharpen the pencil on both sides and carve the wood from the pencil at various points along the length of the pencil. This is easier than trying to remove the entire graphite rod from the pencil. The graphite is soft and often breaks into pieces if you try to remove the entire thing.

The ammeter is not strictly necessary. If you do not have one, then the learners can use the brightness of the bulb as an indication of the strength of the current.

INSTRUCTIONS:

Set up a circuit as in the diagram below with the battery, ammeter, light bulb and graphite rod connected in series. Use crocodile clips to attach the wires to each end of the graphite rod.

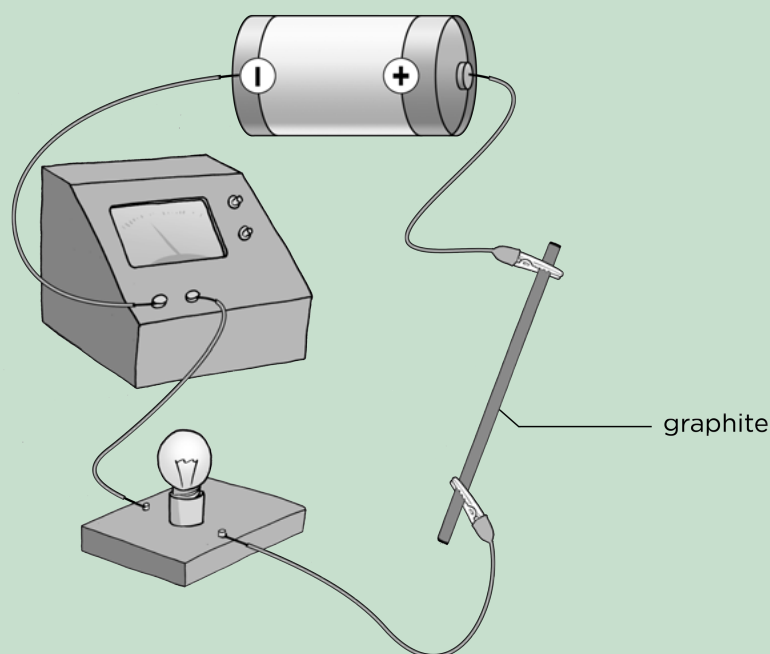

1. Does current flow through the circuit? How do you know?
Yes. The light bulb glows and the ammeter has a reading on it.
2. The crocodile clips are connected on either end of the graphite rod. Predict what you think would happen if you moved the crocodile clips closer towards the center of the piece of graphite.
Learners' predictions will vary. They should refer to how they think the length of graphite will affect the current strength.
3. Move the crocodile clips closer towards the centre of the graphite rod. What do you observe?

The light should burn brighter and the ammeter reading should increase.

4. How do you think the length of the graphite connected to the circuit has affected the current strength?

The shorter the length, the smaller the resistance and so the current strength is greater. By changing the length, the resistance has changed.

5. Draw a circuit diagram to represent this set-up.

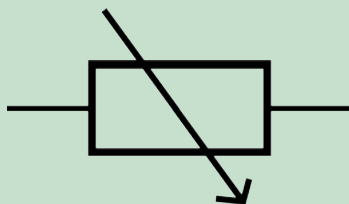

The symbol for a variable resistor.

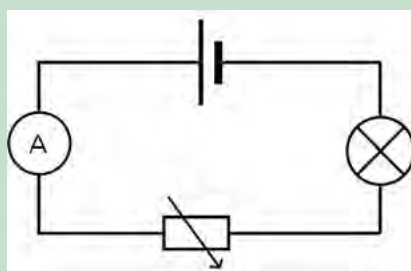

The graphite rod was behaving as a rheostat. The resistance of the graphite rod was changed by changing the length connected to the circuit. A dimmer switch often has a dial which can be turned. Turning the dial increases the resistance of the circuit and makes the light dim. Why do you think this happens?

TEACHER'S NOTE

When the resistance is increased, the current decreases, and so the brightness of the bulb decreases.

Turning the dial in the opposite direction causes the resistance to decrease and so the light burns brighter. Turning the dial changes the resistance of the rheostat in the switch.

TAKE NOTE

A diode is an electrical component that has a very low resistance to current flow in one direction, and high resistance in the other direction. Therefore, current can only move in one direction.

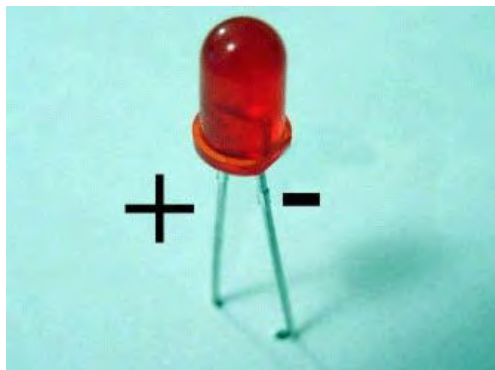

A small LED light.

Another device which demonstrates the useful application of resistance is in an **LED**. LED stands for light emitting diode.

An LED is a diode because it only allows current to pass through it in one direction. This means that it has to be put into a circuit in a very specific way. LEDs are very sensitive to high currents so when they are connected in a circuit, they need to be protected by a large resistor. The resistor is used to control the current which is allowed to travel through the LED. This is another useful application of resistance.

Many households are choosing to replace incandescent light bulbs with LEDs. Are LEDs a more efficient form of lighting?

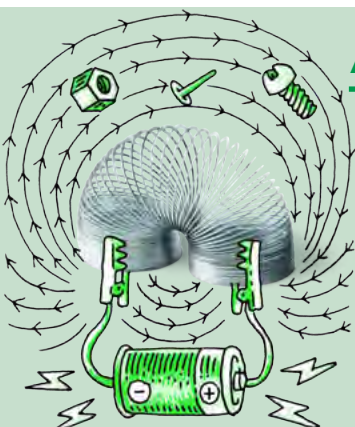

ACTIVITY: Comparing an LED to a filament light bulb

We can use a **Sankey diagram** to show how the energy is transferred in a system. This gives us a picture of what is happening and shows the input energy and how the output energy is made up of useful energy (arrow at the top) and wasted energy (arrow going to the bottom). Have a look at the following general example.

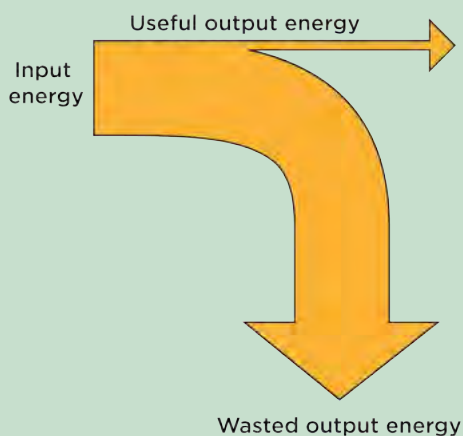

VISIT

Video on drawing a basic Sankey diagram.
bit.ly/1bYKPQx

The width of the arrows tell us something in these diagrams. The input energy is the width of the original arrow. The width of both the output energy arrows (useful and wasted) add up to the width of the input arrow. Why do you think this is so?

TEACHER'S NOTE

This is because energy is neither created nor destroyed, but conserved within a system. So the input must equal the output energy in a system.

Sankey diagrams are drawn to scale so that the width of the arrows gives us a visual idea of how much energy is useful and how much is wasted.

QUESTIONS:

1. The Sankey diagram for an LED is shown below.

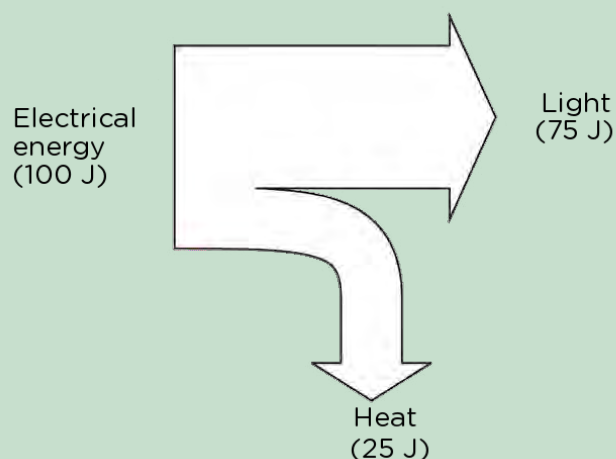

- a) Describe the energy transfer which takes place in an LED, based on the given Sankey diagram.
 - b) Is the LED efficient or inefficient? Explain your answer.
 - a) *If 100 J of electrical energy is transferred to the LED then the LED transfers 75 J of energy as light and 25 J of energy as heat.*
 - b) *The LED is efficient. The main purpose of the LED is to produce light, most of the energy transferred by the LED produces light and only a small percentage is "wasted" as heat (25 %).*
2. The Sankey diagram for an incandescent light bulb is shown below

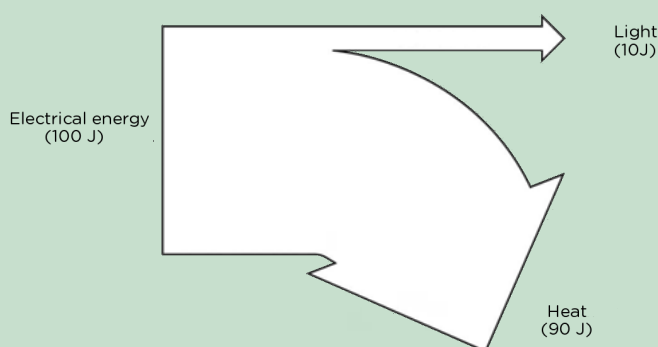

- a) Explain the energy transfers in the incandescent light bulb.
- b) Is the incandescent light bulb efficient? Explain your answer.
 - a) *If 100J of energy is transferred to the light bulb then 90% of the energy is transferred to the surroundings as "wasted" heat. Only 10% of the energy is used to produce light.*
 - b) *The incandescent light bulb is inefficient. The purpose of the incandescent light bulb is to produce light. 90% of the energy it transfers is wasted and only 10% is useful light.*

3. If you are trying to reduce your electricity consumption in order to save money, which light source would you choose? Why?
LEDs as they are more energy efficient. The useful output energy is greater than the wasted output energy.

When we built our own rheostat, we were able to vary the resistance by changing the length of the graphite rod. This tells us that the length of the rod affected the amount of resistance. Let's look at what other factors which affect the resistance of a conductor.

3.3 Factors that affect resistors

What determines the resistance of a component? Let's investigate some of the factors. There are four different factors which affect resistance:

- The type of material of which the resistor is made
- The length of the resistor
- The thickness of the resistor
- The temperature of the conductor

TAKE NOTE

We can say that resistance and current in an electric circuit are **inversely proportional**, because as the one increases, the other decreases, and vice versa.

Type of material

TEACHER'S NOTE

It is not necessary to test each of the factors which affect resistance. Testing the type of material is the easiest method for the learners to pursue in class. As an extension, you could have the learners do a small project on how the cross-sectional area of the material affects resistance or how temperature affects resistance.

Conductors can be made of different materials. Do different materials have different resistances?

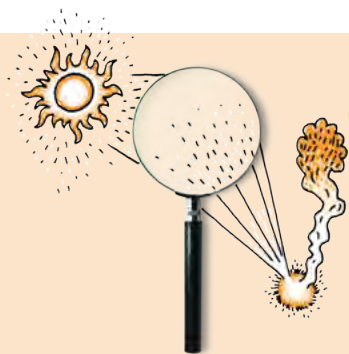

INVESTIGATION: How does the material of the resistor affect the resistance?

How can we measure the resistance? Do you remember that in a series circuit, if we increase the resistance, then the strength of the current decreases? This means that we can use the strength of the current in the circuit as an indication of the amount of resistance in the circuit.

AIM: To determine whether different types of conducting materials have different resistances.

HYPOTHESIS:

1. Write a hypothesis for this investigation.
Possible hypotheses are: Different conductors will provide different

amounts of resistance in an electrical circuit. The type of material will determine the amount of resistance.

VARIABLES

1. Which variables would we need to keep constant in an investigation such as this?
The materials we test would all need to have the same length and thickness and be kept at the same temperature. The number of batteries used to provide energy in the circuit.
2. Which variable is the independent variable?
The independent variable is the type of material.
3. Which variable is the dependent variable?
The dependent variable is the amount of resistance provided by the material, as indicated by the change in current.

TEACHER'S NOTE

This experiment does not measure resistance directly, but rather uses ammeter readings. Later on in this investigation learners are required to draw a bar graph. The bar graph will have ammeter readings (current) on the y-axis.

MATERIALS AND APPARATUS:

- three 1,5 V cells
- insulated, conducting wires with crocodile clips
- conductors of different materials to test
- ammeter
- light bulb

TEACHER'S NOTE

Use whichever metals you have available. Good materials to use are copper (a thicker gauge than those in the normal conducting wires), nickel, nichrome and iron.

METHOD:

1. Set up a circuit with the three cells, ammeter and light bulb connected in series.
2. Test each of the conductors by adding each to the circuit individually. Use crocodile clips to connect each conductor to the circuit, as shown below.

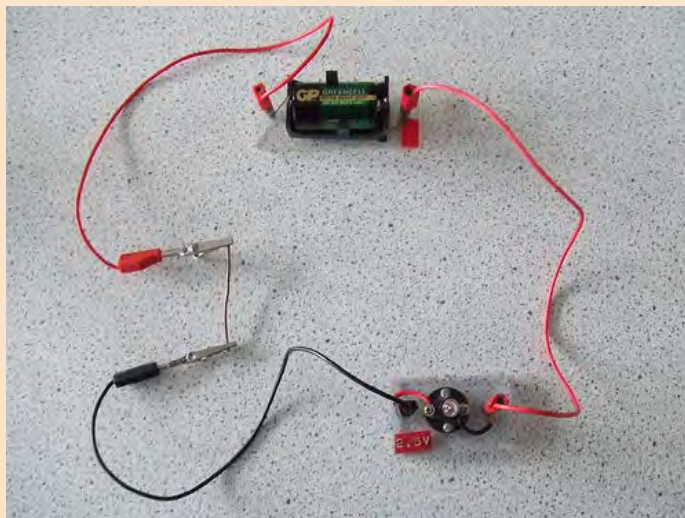

A similar setup showing a light bulb, one cell and a piece of copper wire connected in series.

3. Read the ammeter and record the reading for each test material.
4. Draw a bar graph to show your results.

RESULTS:

1. Draw a circuit diagram of the setup.
Here is an example circuit diagram. The way in which learners represent the connection points for the material to be tested may vary.

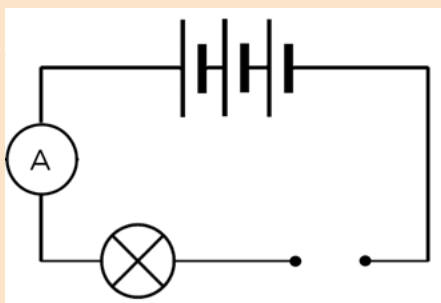

2. Draw a table showing your results.
*An example table is shown here:
Table showing the ammeter readings for each type of conducting material tested*

Conducting material	Ammeter reading (A)
Copper	
Nickel	
Nichrome	
Iron	

Learners must provide a heading for the table and each column, and the unit must be in the heading. You can also use Assessment Rubric 4 at the back of your Teacher's Guide for a more detailed assessment.

3. Draw a bar graph of your results in the space provided.
Learners must provide a heading for the graph, such as 'Graph showing the current in an electric circuit with different types of conducting materials being tested.' The type of material must be on the x-axis and the ammeter reading on the y-axis. The bars must not be touching in this type of bar graph as the data is not continuous. For a more detailed assessment, refer to Assessment Rubric 3.

ANALYSIS AND EVALUATION:

1. Which material offered the most resistance in the electric circuit? How do you know this?
This will depend on the materials used, but the material which has the lowest ammeter reading, and therefore the lowest current, has the highest resistance.
2. Which material offered the least resistance in the electric circuit? How do you know this?
This will depend on the materials used, but the material with the highest ammeter reading will have the lowest resistance.
3. Are there any potential problems with the way in which this investigation was set up, or are there any ways in which you could have improved the design?
Learners' responses will vary but the learners should mention that it is difficult to control the temperature of the conductors and that they should read the ammeter reading immediately upon adding their test material to the circuit.

CONCLUSIONS:

1. What conclusion can you reach from this investigation?
The type of material from which the resistor is made affects the resistance. Different materials offer different amounts of resistance.
2. Why must the different conductors have the same length and thickness?
Length and thickness can also affect amount of resistance. We only want to test one variable at a time and therefore other variables must remain

Thickness of the conductor

When we investigate the thickness of a conductor, we are looking at the cross-sectional area of the wire, called the gauge. This is shown in the following diagram.

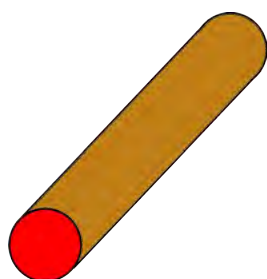

The cross-sectional area of a wire is indicated by the red circle.

Do you think the thickness of a wire will affect the resistance? Let's do an investigation to find out.



INVESTIGATION: How does the thickness of the conductor affect the resistance?

AIM: To determine whether the thickness of the conductor will affect the resistance.

HYPOTHESIS: Write a hypothesis for this investigation.

TEACHER'S NOTE

Possible hypotheses are:

- The thicker the conductor, the smaller the resistance.
- The thinner the conductor, the smaller the resistance.

VARIABLES:

1. Which variables would we need to keep constant in an investigation such as this?
The wires used must all be of the same material (for example, copper), the same length and the same temperature. The number of batteries used to provide energy in the circuit.
2. Which variable is the independent variable?
The independent variable is the thickness of the wire.
3. Which variable is the dependent variable?
The dependent variable is the amount of resistance provided by the different wires, as measured by changes in current.

MATERIALS AND APPARATUS:

- three 1,5 V cells
- insulated, conducting wires with crocodile clips
- conductors of different thickness
- ammeter
- light bulb

TEACHER'S NOTE

A suggestion is to use three equal lengths of copper wire with different thicknesses.

METHOD:

1. Assess the lengths of wire that you have and arrange them in order from thickest to thinnest. Label the thickest wire as 1, the next thickest as 2, and so on, so that you can easily record the results.
2. Set up a circuit as in the previous investigation with the three cells, ammeter and light bulb connected in series.
3. Test each of the different wires by adding each to the circuit in turn. Use the conducting wires with crocodile clips attached at the ends to join each conductor to the circuit.

4. Read the ammeter and record the reading for each wire.

RESULTS:

Draw a table showing your results.

TEACHER'S NOTE

An example table is shown here:

Table showing the ammeter readings for each thickness of wire used

Wires of different thicknesses	Ammeter reading (A)
1 (thickest)	
2	
3 (thinnest)	

Learners must provide a heading for the table and each column, and the unit must be in the heading. You can also use Assessment Rubric 4 at the back of your Teacher's Guide for a more detailed assessment.

ANALYSIS AND EVALUATION:

1. Which thickness of wire offered the most resistance in the electric circuit?
The thinnest wire offers the most resistance.
2. Which thickness of wire offered the least resistance in the electric circuit?
The thickest wire offers the least resistance.
3. Are there any potential problems with the way in which this investigation was setup, or are there any ways in which you could have improved the design?
Learners' responses will vary but the learners should mention that it is difficult to control the temperature of the conductors and that they should read the ammeter reading immediately upon adding their wire to the circuit.

CONCLUSIONS:

1. What conclusion can you reach from this investigation?
The thickness of the wire does affect the resistance. The thinner the wire, the higher the resistance.
2. Can you accept or reject your hypothesis?
Learner-dependent answer.

The thinner the wire, the more resistance it offers. Thicker wires offer less resistance. This is easy to understand if you think back to the example of all the learners filing back into the classrooms after break. If the corridor is narrow (or thin) then it is harder for all the learners to move through. A very wide corridor would be easier to move through as it offers less resistance. This is the same in a conducting wire. A thinner wire is more difficult for electrons to move through than a thicker wire.

TEACHER'S NOTE**Optional, online simulation:**

If you have access to the internet for your students then you can do the activities listed in this subsection. The simulation referred to in the activity can be found here bit.ly/1cXLK35

Alternatively, the PhET simulation for investigating resistance in a wire listed in the visit box can also be used.

The simulation opens by showing the value of the resistance of a 50 cm length of 26 SWG constantan wire as being 1,585 ohms. This resistance is given to three decimal places and shown in the yellow area of the display screen. There is a reset button at the top of the screen which will set the simulation back to the resistance of a 50 cm length of 26 SWG constantan wire.

There are various sliders on the screen where you can adjust the length, material type and cross-sectional area of the resistor. Take some time to familiarise yourself with the simulation before allowing the learners to use the simulation. Here is an example of the investigation you could do.

Investigation: How does the diameter or cross-sectional area of the wire affect the resistance of the wire ?**MATERIALS AND APPARATUS:**

- Resistance simulation from bit.ly/1cXLK35

METHOD:

1. Open the simulation.
2. Change the diameter of the resistor according to the table below. Do not change any other factors.
3. Write down the resistance (shown in the yellow block on the screen) which corresponds to each wire diameter.
4. Draw a graph of your results.

RESULTS:

Wire diameter (mm)	Cross-sectional area of wire (mm ²)	Resistance (ohms)
1		
2		
3		
4		

Draw a graph of wire diameter versus resistance.

CONCLUSIONS:

As the diameter of the wire increases, the resistance **decreases**. In fact, if we double the cross-sectional area then the resistance **halves**. This means that resistance is **inversely** proportional to the area of the wire.

VISIT

Learn about the resistance in a wire with this simulation. Change its length and area to see how they affect the wire's resistance.
bit.ly/1aqYfOT

Length of the conductor

In each of the previous investigations, we have used the same length for each conductor. It was a controlled variable. Let's now investigate how the length of a conductor affects the resistance.

INVESTIGATION: How does the length of a conductor affect the resistance of the conductor?

HYPOTHESIS: Write a hypothesis for this investigation.

TEACHER'S NOTE

A possible hypothesis is: The longer the length of the conductor, the higher the resistance.

MATERIALS AND APPARATUS:

- piece of resistance wire (110cm) long
- ammeter
- two 1.5 V cells
- metre ruler
- tape
- insulated copper conducting wires

TEACHER'S NOTE

The wire must be without any insulation. Copper wire often has varnish as insulation and therefore will not work. Nichrome or constantan wire work well (between 28 and 32 SWG - the SWG rating indicates the cross-sectional area of the wire). Other wires can also be used. The length is a suggestion only. If you are only able to obtain smaller lengths, the learners will take fewer readings. If you do not have an ammeter then use a light bulb as an indicator of current strength. You want about 3 V for this circuit so any combination of cells which provide 3 V would work, or a low voltage power supply.

VARIABLES:

1. Which variables would we need to keep constant in an investigation such as this?
The wires used must all be of the same material (for example, copper). The number of batteries used to provide energy in the circuit.
2. Which variable is the independent variable?
The independent variable is the length of the wire.
3. Which variable is the dependent variable?
The dependent variable is the amount of resistance provided by the different length of the wire, as measured by changes in current.

METHOD:



VISIT

Watch a video on this investigation on length of a resistor. bit.ly/1c0cNvf

1. Tape the resistance wire to the metre ruler. Make sure the wire is stretched flat and that the numbers on the ruler are still visible.
2. Assemble a circuit according to the following diagram.

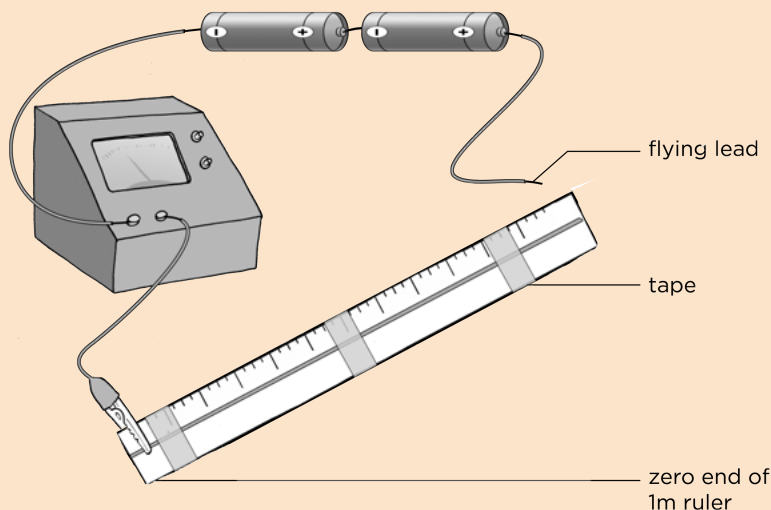

3. Use the flying lead and touch it to the resistance wire at the 1 m mark. Record the ammeter reading.
4. Use the flying lead and touch it to the resistance wire at the 0,9 m mark. Record the ammeter reading.
5. Move the flying lead in 10 cm intervals until you have 10 readings. Record the ammeter reading each time.

RESULTS:

VISIT
 Experiment with this simulation by changing the wire diameter and length to see the effect each has on the resistance.
bit.ly/174rdsp

TEACHER'S NOTE

The results obtained in this investigation will depend on the type of material chosen and the SWG rating of the wire chosen.

Record your results in the following table.

Length of wire (m)	Ammeter reading (A)
1,0	
0,9	
0,8	
0,7	
0,6	
0,5	
0,4	
0,3	
0,2	
0,1	

Draw a graph to show the relationship between the length of the resistor and the ammeter readings.

TEACHER'S NOTE

The graph should have the independent variable (length) on the x-axis and the dependent variable (ammeter reading) on the y-axis. The graph should show that as the length of the resistance wire increases, the ammeter reading decreases. It is unlikely to be a straight line. Learners must provide a heading, such as "Graph showing the change in current in a circuit as the length of a conducting wire is varied."

As an extension, learners can rather calculate the resistance using the formula $R = V/I$ and then plot resistance versus length directly.

CONCLUSIONS:

1. Look at your table and graph. What conclusion can you draw?
There is a relationship between the length of the resistor and the current strength. Increasing the length of the conductor decreases the current strength.
2. What is causing the decrease in current strength?
Current is affected by resistance. If the current has decreased, it must mean that the resistance has increased.
3. What can you conclude about the relationship between the length of the resistor and the resistance of the resistor?
Increasing the length of the resistor increases the resistance of the resistor.



The length of the resistor affects how much resistance it offers to the circuit. The longer the resistor, the more resistance it has. The shorter the resistor, the less resistance it has.

TEACHER'S NOTE

Optional, online simulation:

If you have access to the internet for your students then you can do an online simulation. The simulation referred to in the activity can be found here
¹ bit.ly/1cXLK35

Alternatively, the PhET simulation for investigating resistance in a wire listed in the previous visit box can also be used.

The simulation opens by showing the value of the resistance of a 50 cm length of 26 SWG constantan wire as being 1,585 ohms. This resistance is given to three decimal places and shown in the yellow area of the display screen. There is a reset button at the top of the screen which will set the simulation back to the resistance of a 50 cm length of 26 SWG constantan wire.

There are various sliders on the screen where you can adjust the length, material type and cross-sectional area of the resistor. Take some time to familiarise yourself with the simulation before allowing the learners to use the simulation. Here is an example of the investigation you could do.

Investigation: How does the length of the wire affect the resistance of the wire ?

MATERIALS AND APPARATUS:

- Resistance simulation from ² bit.ly/1cXLK35

METHOD:

1. Open the simulation.
2. Change the length of the resistor according to the table below. Don't change any other factors.
3. Write down the resistance (shown in the yellow block on the screen) which corresponds to each wire length.
4. Draw a graph of your results.

RESULTS:

Wire length (cm)	Resistance (ohms)
10	
20	
30	
40	
50	
60	
70	
80	
90	
100	

Draw a graph of wire length versus resistance

CONCLUSIONS

As the length of the wire increases, the resistance **increases**. In fact, if we double the length then the resistance **doubles**. This means that resistance is directly **proportional** to the length of the wire.

Longer wires have more resistance than shorter wires. Let's take a close-up look at the filament of an incandescent light bulb.

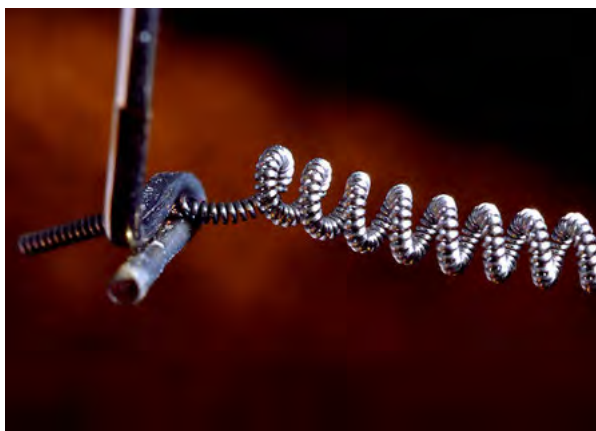

A close-up photograph of the tungsten filament in an incandescent light bulb.

You can see that the filament is made up of coils of tungsten wrapped up tightly. We want to fit a very long wire into a small space. The electrons have to travel through this very long, high-resistance wire. How is this more beneficial compared to having a shorter wire? Discuss this with your class.

TAKE NOTE

We are not going to investigate this factor as it is difficult to control the temperature of a wire in an investigation.

VISIT

Factors affecting resistance.bit.ly/HdxCVx

TEACHER'S NOTE

A longer wire increases the resistance. The electrons travelling through the wire therefore transfer a lot of energy to the wire in the form of heat and light. A shorter wire would not provide as much heat and light.

Temperature of the conductor

The last factor which affects resistance is the temperature of the conductor. The hotter a resistor becomes the more resistance it has. The atoms of the conductor vibrate much faster when they are hot due to the increase in kinetic energy. This makes it more difficult for the electric current to move through. Cold resistors offer less resistance to the circuit.

SUMMARY:

Key Concepts

- Resistance is the opposition to electric current in a circuit.
- A resistor is an electrical component used to add resistance to an electrical circuit.
- Resistance can be useful. For example, the filament in a light bulb and a toaster have a high resistance.
- There are four factors which influence the amount of resistance of a conductor: type of material, length, thickness and temperature.
- Different materials will offer different amounts of resistance.
- Longer length resistors will offer more resistance than shorter resistors.
- Thicker resistors offer less resistance than thinner resistors.
- Hot resistors offer more resistance than cold resistors.

Concept Map

Complete the following concept map to summarise what you have learnt about resistance in this chapter. For example, when looking at the factors that affect resistance, you need to describe the relationship by completing the sentences.

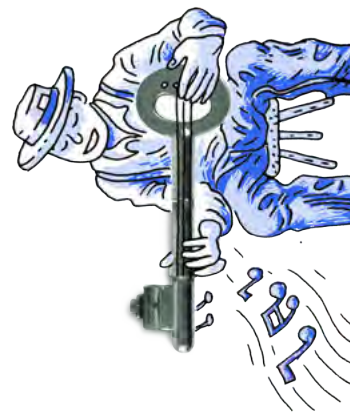

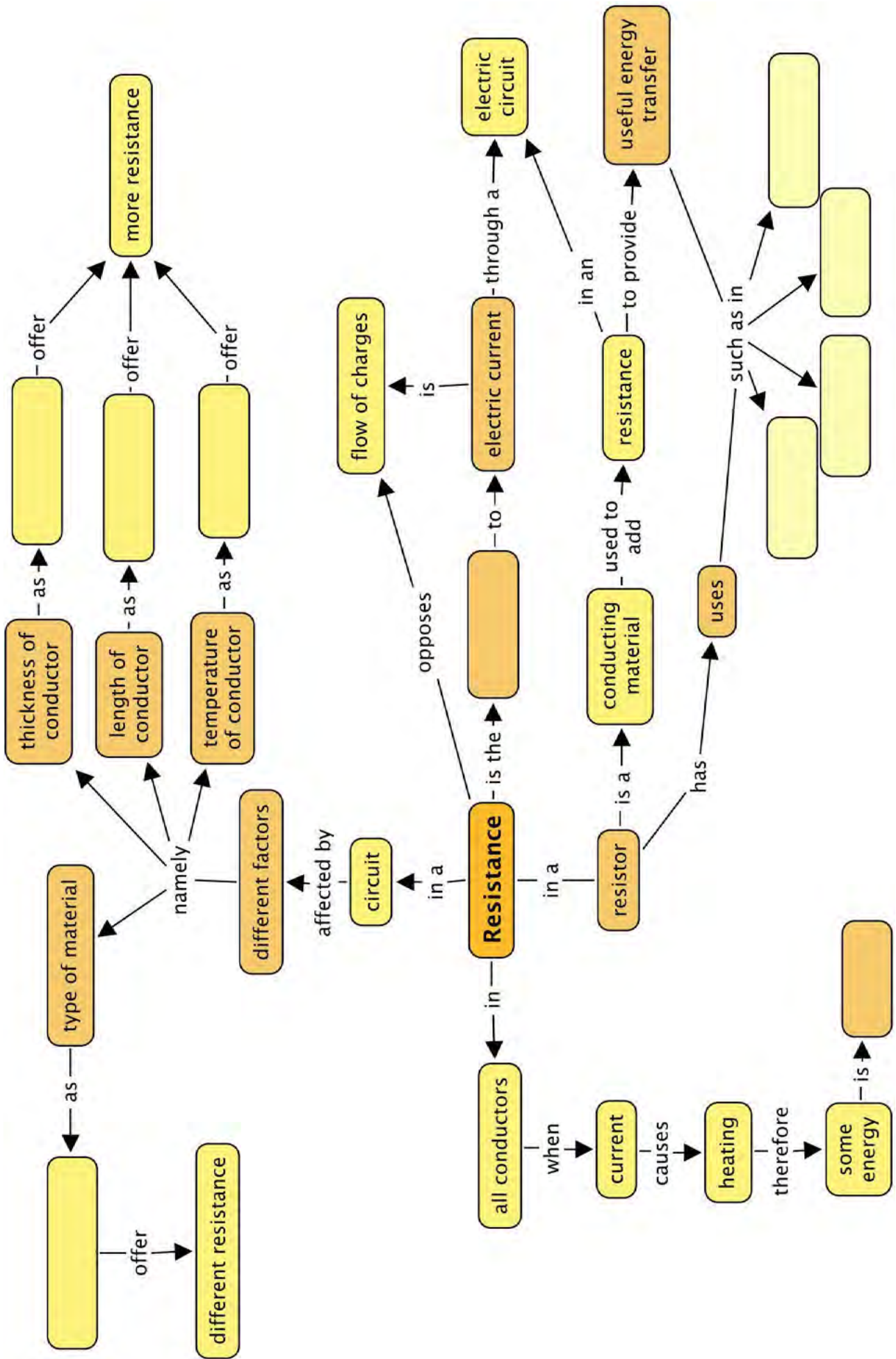

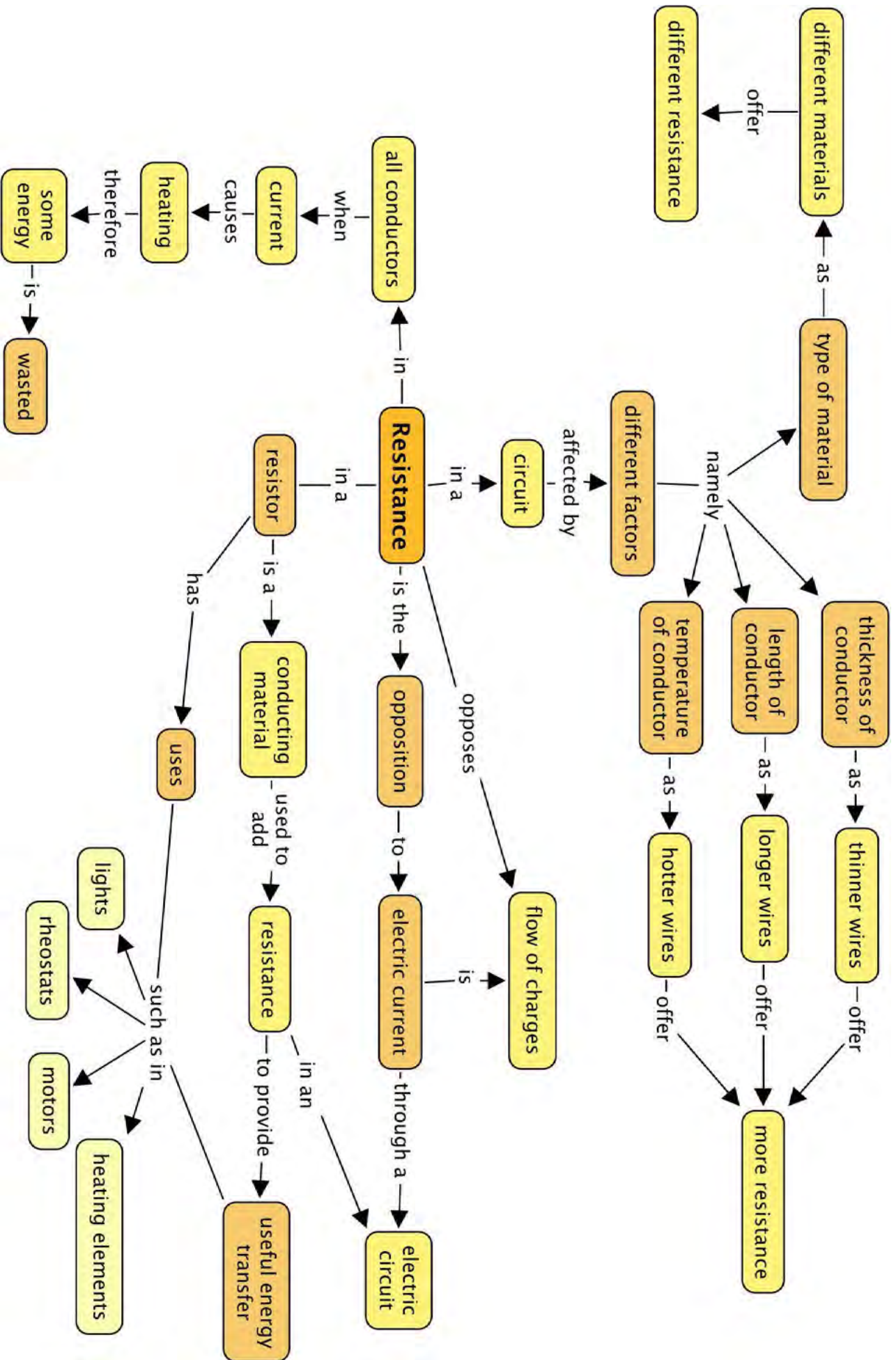

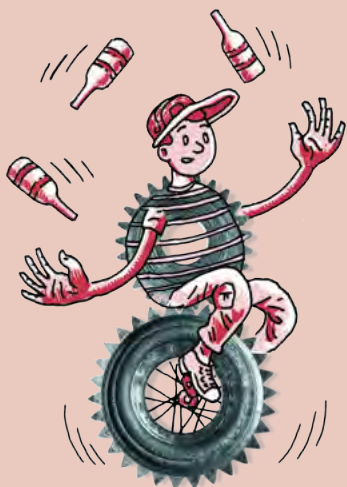

REVISION:

1. There are many useful applications of resistance. Give two examples of appliances which require large resistances in order to function. [2 marks]
Kettle, stove top plate, light bulb, heaters.
2. Look at the following photograph of an electric toaster.



An electric toaster.

- a) Do you think the element in the toaster has a low or high resistance? Explain your answer. [2 marks]
 - b) Explain the energy transfers which take place within the heating element of the toaster. [3 marks]
 - c) Is there wasted energy in this system? If so, what is it and why can we consider it 'wasted energy'? [2 marks]
 - *The element has a high resistance as it is opposing the electric current which causes the wire to heat up and glow.*
 - *The electrical energy is transferred to the heating element. The heating element has a high resistance and so a lot of energy is transferred. The element glows and warms up. The heating element becomes very hot and transfers that energy to the bread to toast it.*
 - *The light given off by the element can be considered as wasted energy as this is not used to toast the bread.*
3. List the factors which affect the amount of resistance in a resistor [4 marks]
 - *length of material*
 - *type of material*
 - *temperature of resistor*
 - *cross-sectional area of resistor*
 4. The pictures below show two pieces of the same type of metal wire with the same diameter.

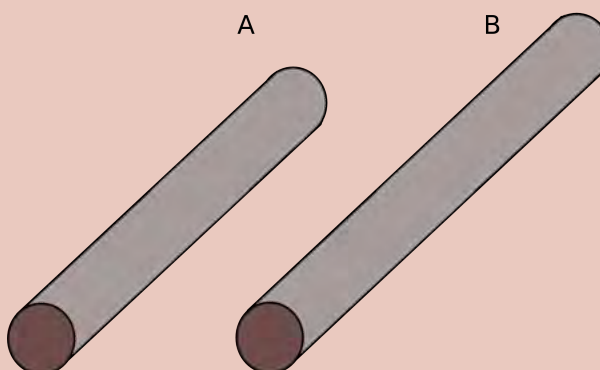

Which piece has the higher resistance? Explain why. [2 marks]

Wire B has the higher resistance as it is longer. The longer the resistor, the higher the resistance as the electrons have further to move through the wire.

5. The pictures below show cross sections of two pieces of the same type of metal wire. The pieces are the same length but have different diameters.

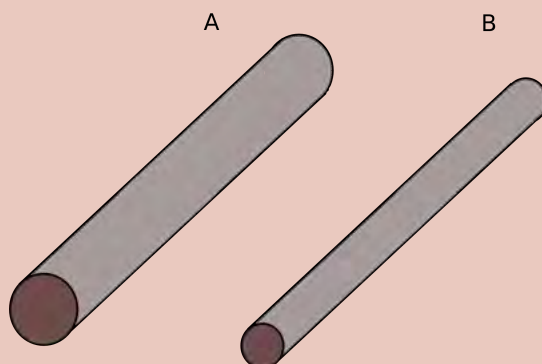

Which piece has the lower resistance? Explain why. [2 marks]

Wire A has the lower resistance. It has a thicker diameter and so there is less resistance as there is more space for the electrons to move through the wire.

6. Look at the image of a stove top heating element. The heating element offers a large resistance to the flow of electric current.



- Why is the heating element in the shape of a coil? [2 marks]
- What is the input energy in this system? [1 mark]
- What is the output energy? [2 marks]
- Is all of the energy transferred to the heating element useful? [2 marks]
 - This increases the surface area for heating. It allows a longer resistor in a smaller area to increase the efficiency of the stove.*
 - Electrical energy.*
 - Light and heat.*
 - The purpose of the heating element is to heat food. Most of the energy transferred to the element is used to heat the element. This means that most of the energy is useful. The energy which is used to produce light is not useful, but it is a small amount compared to the heat.*

Total [26 marks]



TEACHER'S NOTE**Chapter overview**

2 weeks

Learners have already been introduced to series and parallel circuits in Gr. 8. However, they will now learn more detail about how the circuits function. They will be introduced to the concept of potential difference. It would be useful to revise some of the investigations covered in the Gr. 8 syllabus as activities this year. Some of these activities have been included here in the Gr. 9 workbook again. You can easily access the Gr. 8 content online at ¹ www.curious.org.za. This will help learners to remember and revise the concepts that they learnt a full year ago. If you feel that learners already grasp these concepts, then rather spend more time on the investigations. As an extension, you can do more calculations in class. Some calculations have been included here, such as calculating resistance given the potential difference and current.

Note: In CAPS, the term 'voltage' is predominantly used, however, here in these workbooks, the term 'potential difference' is rather used as this is the correct scientific term to use. Potential difference is also the term used in FET level and beyond.

If you only teach Natural Sciences, it is a good idea to check with the Technology teachers to see how these two curriculums complement each other, especially with regard to electricity. Some of the concepts which might be introduced for the first time in Natural Sciences, have already been covered in the Technology curriculum. Knowing what learners have already covered and been introduced to will help make your classes more efficient and more stimulating for learners.

A useful device to use in the investigations and activities in this chapter is a multimeter. Find out more about multimeters and how to use them in this video: ² bit.ly/16qtjg6 Remember that you just need to type this link into the address bar in your internet browser and press enter, in order to access the video.

4.1 Series circuits (3 hours)

Tasks	Skills	Recommendation
Investigation: What is the effect of the number of cells connected in series on current and potential difference?	Investigating, predicting, hypothesising, taking readings, observing, analysing and displaying data	CAPS suggested
Investigation: The effect of the number of cells connected in series on current strength and potential difference	Investigating, predicting, hypothesising, analysing, concluding	Optional PhET simulation investigation

Tasks	Skills	Recommendation
Activity: Increasing the resistance in a series circuit	Following instructions, observing, describing, explaining	CAPS suggested
Investigation: Measuring the potential difference across components in a series circuit	Investigating, predicting, hypothesising, taking readings, observing, calculating, analysing	CAPS suggested
Activity: Check your knowledge of series circuits	Comparing, predicting, analysing, explaining	Optional revision
Activity: Current in a series circuit	Recalling, following instructions, drawing, taking readings, analysing, concluding	CAPS suggested

4.2 Parallel circuits (3 hours)

Tasks	Skills	Recommendation
Investigation: What happens to the current and potential difference in a circuit when adding cells in parallel?	Investigating, predicting, hypothesising, taking readings, drawing, observing, analysing	CAPS suggested
Activity: Adding resistors in parallel	Following instructions, observing, describing, explaining	CAPS suggested
Activity: Current in a parallel circuit	Recalling, following instructions, drawing, taking readings, calculating	CAPS suggested
Investigation: Measuring the potential difference across components in a parallel circuit	Investigating, predicting, hypothesising, taking readings, drawing, observing, analysing	CAPS suggested
Activity: Series and parallel circuits	Following instructions, observing, describing, explaining	CAPS suggested



KEY QUESTIONS:

- What happens when we add cells in series or parallel?
- What happens when we add resistors in series or parallel?
- What is potential difference?
- How do we connect ammeters and voltmeters in circuits?

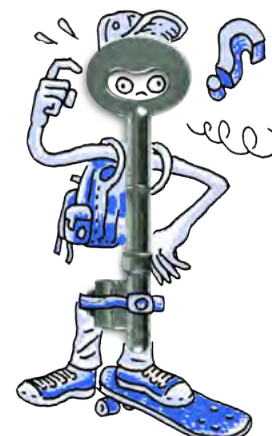

4.1 Series circuits

A series circuit provides only **one** path for electric current to move through the circuit.

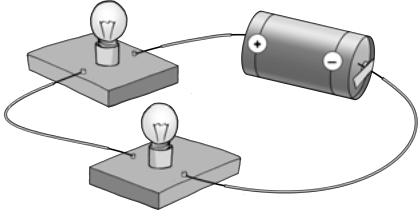
Series circuit	Draw a circuit diagram for this circuit
	

TEACHER'S NOTE

The circuit diagram for the above circuit is as follows:

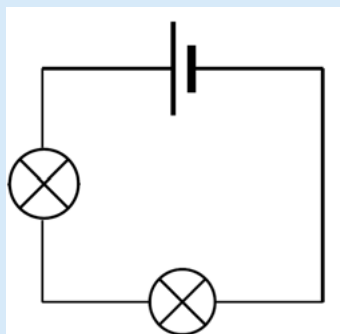

TAKE NOTE

Remember that a battery is a group of cells connected together.

How many cells and how many resistors are in the above circuit?

TEACHER'S NOTE

There is one cell and there are two resistors (light bulbs).

What happens when more cells or resistors are added into a series circuit? We are going to investigate the effects on the current and the potential difference in series circuits.

What is potential difference?

TEACHER'S NOTE

A useful video to watch in order to explain potential difference and current to your learners, in terms of the analogy of a river. This video was not included in the learners book as some of the concepts are beyond the scope of the curriculum at this stage, such as a coulomb of charge. ³ bit.ly/Havmzk

Potential difference is the difference in potential energy per charge between two different points in an electric circuit. Here is a simpler explanation: potential difference tells us how much energy per charge the electrons are losing when they pass through a resistor or how much they are gaining when they pass through the cell or battery. The electrons "lose" energy because they have transferred it to the resistor in the form of heat, light or sound. Electrons "gain" energy when they pass through the cell or battery because of the chemical energy from the battery being transferred to the electrons.

The potential difference is measured by a **voltmeter**. The unit of potential difference is the **volt**.

The voltmeter has a very high internal resistance and must be connected in parallel with the component you are measuring. You therefore need to connect it to two different points (which are usually, before and after a resistor). The voltmeter calculates the potential difference between those two points. An example illustrating the placement of a voltmeter at two points, (A and B) is indicated in the diagram below.



A voltmeter.

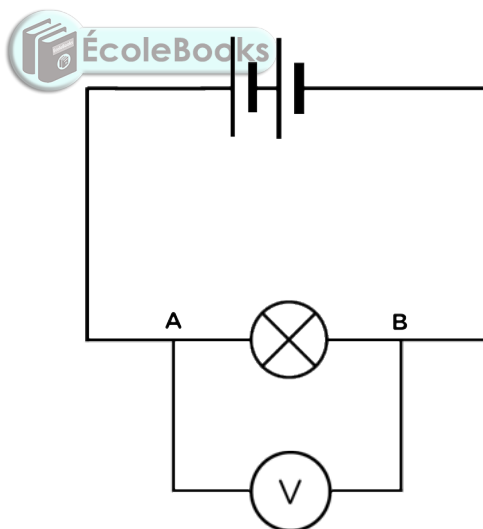

This voltmeter is connected in parallel with the bulb and measures the potential difference between points A and B.

If you connect the voltmeter in series, there will not be two different points as you connect it to the same wire with the same potential difference. What do you think would happen if you connected the voltmeter in series in the circuit? Explain your answer.

TAKE NOTE

You might have learnt about potential difference in Technology already, but this is the first time we are investigating it in Natural Sciences.

TAKE NOTE

Some people often use the term **voltage** to describe the potential difference. This is based on the fact that we measure potential difference in **volts**. Voltage is not the scientific term, and potential difference is the more correct term to use.

TEACHER'S NOTE

This would affect the current in the circuit as the voltmeter provides a very high resistance so the current would not flow through the circuit, or there would be a very small current.

What do we use to measure the current in a circuit?

TEACHER'S NOTE

An ammeter.

How do we connect this device into a circuit? Explain why this is so.

TEACHER'S NOTE

The ammeter is connected in series as we need to measure the current so all the current must flow through the ammeter.

Do you think the ammeter has a large or a small resistance? Explain your answer.

TEACHER'S NOTE

The ammeter has a very small resistance so that it does not oppose the current and affect the reading.

Draw a circuit diagram in the following space to illustrate an ammeter, a light bulb and a cell connected in a circuit.

TEACHER'S NOTE

The circuit should look as follows with the ammeter in series:

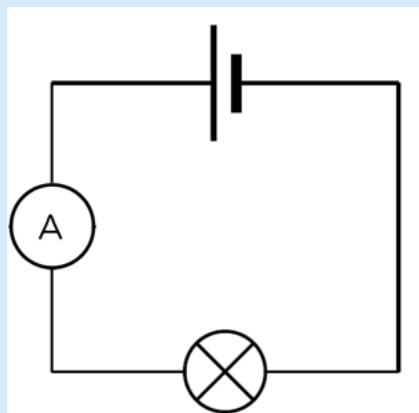

The following photo shows a voltmeter connected in parallel and an ammeter connected in series.

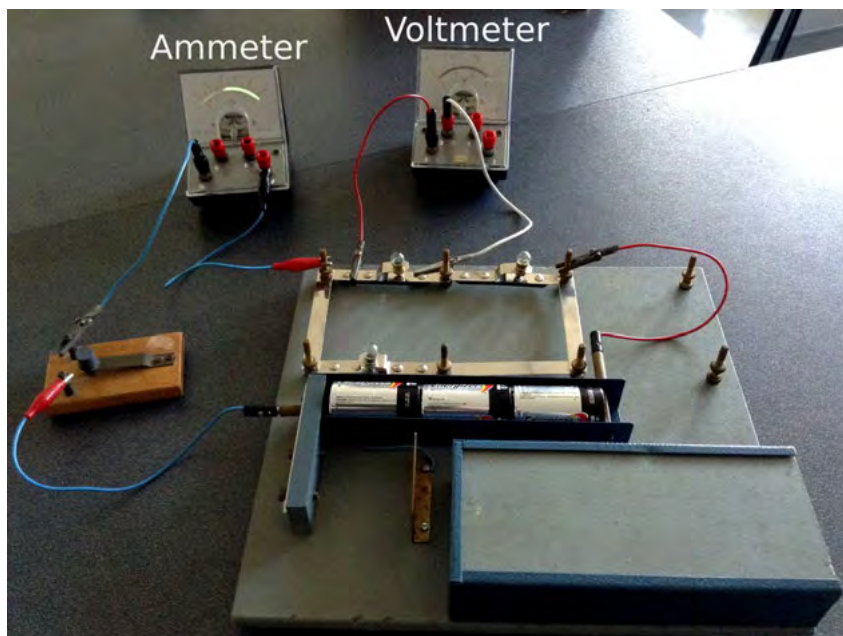

Cells in series

When cells are connected together they are called a battery. What happens when we put more than one cell in a circuit? Let's investigate what happens when we add cells, in series, to a circuit.

TEACHER'S NOTE

If you do not have sufficient equipment to allow all the learners to attempt these circuits. Use the PhET simulation software which can be obtained from bit.ly/17vBMBX.

Before allowing your students to use the PhET simulations there are several things you should familiarise yourself with regarding the software. Make sure you know how to:

- add components to a circuit. You need to click and hold down and drag the components from the side of the screen to where you want them.
- connecting components with wires. You can place a wire onto the screen and then drag the ends till they meet up with the component. Make sure that you are careful when connecting light bulbs. The system will create a short circuit if they are not connected correctly. This will require some practice.
- delete wires or components or to add parts. You can't just add after the circuit is built, just as in a real circuit you need to disconnect components to make space for new ones. Right-click with the mouse on the junction between two components and it will give you the option to disconnect. Right-click on the component itself, and you will be given the option to remove the entire component.
- use the voltmeter and ammeter. The non-contact ammeter is very useful but the other one is more realistic.

- clear the image to start something else. Your learners can save their circuits for future use if your lesson is interrupted and then load them again when you need them. If they need a blank screen in order to start again, then click on the "reset all" button.
- reset the resistance of a resistor or light bulb or to change the potential difference of a battery. Right-click on the component and you will be given the option to adjust the settings.

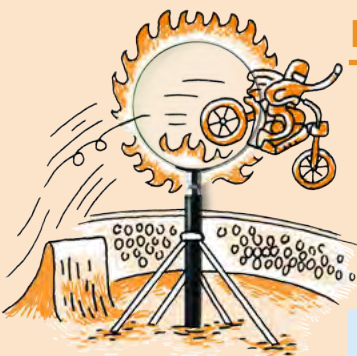

INVESTIGATION: What is the effect of the number of cells connected in series on current and potential difference?

HYPOTHESIS:

Write a hypothesis for this investigation.

TEACHER'S NOTE

Possible hypothesis:

Increasing the number of cells connected in series will increase the current strength and potential difference in the circuit.

Remember that a hypothesis does not have to be "correct", it only needs to mention which variables are being considered and the relationship that is expected to be observed.

TAKE NOTE

If you are using a light bulb and not an ammeter to see the effect, then take note of the brightness of the bulb as you add more cells in series.

MATERIALS AND APPARATUS:

- three 1,5 V cells
- insulated copper conducting wires with crocodile clips
- ammeter
- voltmeter
- resistor or light bulb

METHOD:

1. Construct a series circuit with 1 cell, a resistor and the ammeter in series.
2. Connect the voltmeter in parallel with the cell as shown in the following circuit diagram.

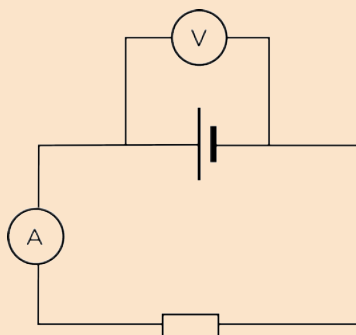

- Record the readings on the ammeter and voltmeter in the table below.
- Add a second cell in series with the first cell.

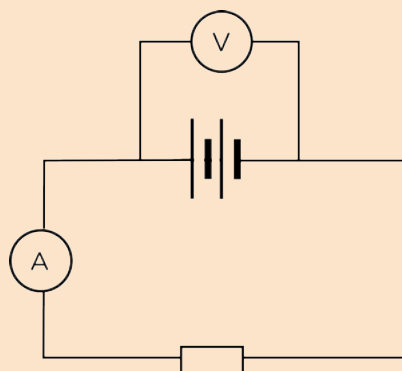

VISIT

A useful video to revise electricity and circuits.
bit.ly/15XAKOK

- Record the new readings on the ammeter and voltmeter in the table below.
- Add the third cell in series with the other two cells.

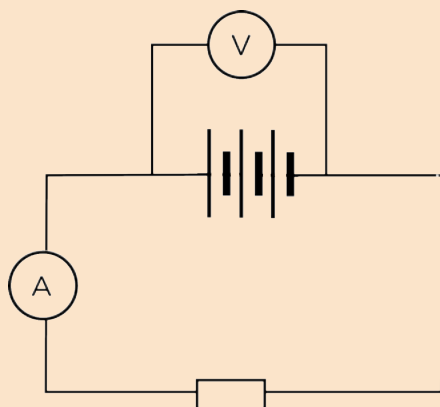

TAKE NOTE

Remember that the units of measurement are noted in the heading for a column in a table and not written in each cell in the table.

- Record the new readings on the ammeter and voltmeter in the table below.
- Draw a graph of your results.

RESULTS:

Complete the following table:

Number of cells	Ammeter reading (A)	Voltmeter reading (V)
1		
2		
3		

TAKE NOTE

A line of best fit (or 'trend' line) is a straight line that best represents the data on a scatter plot. To draw a line of best fit, balance the number of points above the line with the number of points below the line. This line may pass through some of the points, none of the points, or all of the points.

VISIT

How to find the line of best fit.
bit.ly/176NV39

Use your table to draw two line graphs on the same set of axes. One graph should be the number of cells against the current (ammeter reading) and the other graph should be the number of cells against the potential difference (voltmeter reading). Decide which are your independent and dependent variables in this investigation. Draw a line of best fit through the data points.

TEACHER'S NOTE

Learners should plot the number of cells along the x-axis as this is the independent variable. Learners can draw two separate graphs. The plotted points must be visible and learners must draw a line of best fit. Learners must provide a heading for their graph.

If you used a light bulb instead of a resistor, what happened to the brightness of the bulb as you added more cells in series? If you did not do this, predict what would happen.

TEACHER'S NOTE

Adding more cells in series increases the brightness of the bulb.

CONCLUSION:

What can we conclude happens to the current strength and potential difference as more cells are added in series?

TEACHER'S NOTE

Connecting more cells in series into a circuit increases the current strength in the circuit and the potential difference across the cells.

What have we learnt? Increasing the number of cells connected together in series increases the strength of the current in the circuit and the potential difference across the cells.

INVESTIGATION: The effect of the number of cells connected in series on current strength and potential difference

This is an optional investigation using PhET (Physics Education Technology) online simulations. You might do this in class with your teacher or else you can visit the website and interact with the simulation in your own time.

TEACHER'S NOTE

This is an optional investigation. This is essentially the same as the previous investigation but relies solely on the PhET simulation software. The PhET simulation gives concise results which are easier to graph and does not require actual lab equipment.

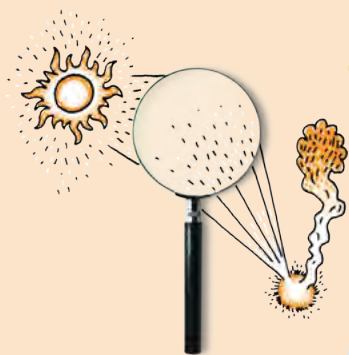

HYPOTHESIS:

Write a hypothesis for this investigation.

TEACHER'S NOTE

Possible answer: Increasing the number of cells connected in series will increase the current strength and potential difference in the circuit.

VISIT

Interact with this simulation to learn more about electric circuits. bit.ly/1gqqTia

MATERIALS AND APPARATUS:

- PhET circuit construction kit (DC only) bit.ly/19eKTHf

METHOD:

1. Construct a series circuit with 1 cell, a resistor and the ammeter in series in the PhET simulation. Drag and drop each component to create the circuit
2. Connect the voltmeter in parallel with the cell.
3. Record the readings in the table below.
4. Add a second cell in series with the first cell.
5. Record the new readings in the table below.
6. Add the third cell in series with the other two cells.
7. Record the new readings in the table below.
8. Draw a graph of your results.

RESULTS:

Complete the following table:

Number of cells	Ammeter reading (A)	Voltmeter reading (V)
1		
2		
3		

Use your table to draw two line graphs. One graph should be the number of cells against the current (ammeter reading) and the other graph should be the number of cells against the potential difference (voltmeter reading). Decide which are your independent and dependent variables in this investigation.

CONCLUSION:

What can we conclude regarding the effect on the current strength and potential difference of adding cells in series into a circuit?

TEACHER'S NOTE

Connecting more cells in series into a circuit increases the current strength in the circuit and the potential difference across the cells.



Resistors in series

Let's revise some of the work we covered in Gr. 8 about series circuits.



ACTIVITY: Increasing the resistance in a series circuit

TEACHER'S NOTE

This is a revision activity of what learners covered in Gr. 8. It can also be done concurrently with the following investigation to look at the effect on the potential difference.

MATERIALS:

- 1,5 V cell
- 3 torch bulbs
- insulated copper conducting wires
- switch
- ammeter

TEACHER'S NOTE

The switch is not an essential part of this investigation. It can be left out of the circuit. If you do not have an ammeter, then use the brightness of the bulbs to indicate current strength.

VISIT

Watch how the brightness of the bulbs changes as you add more in series.
bit.ly/H6suDb

INSTRUCTIONS:

1. Construct the circuit with the cell, the ammeter, 1 bulb and the switch in series.
2. Close the switch.
3. Note how brightly the bulb is shining and record the ammeter reading. Draw a circuit diagram.

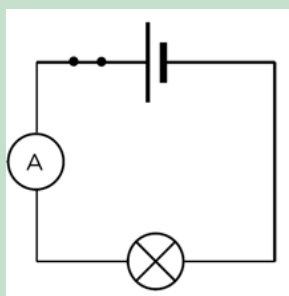

Circuit 1

4. Open the switch.
5. Add another light bulb into the circuit.
6. Close the switch.
7. Note how brightly the bulbs are shining and record the ammeter reading. Draw a circuit diagram.

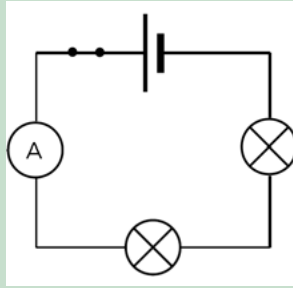

Circuit 2.

8. Open the switch.
9. Add the third light bulb into the circuit.
10. Close the switch.
11. Note how brightly the bulbs are shining and record the ammeter reading.
Draw a circuit diagram.

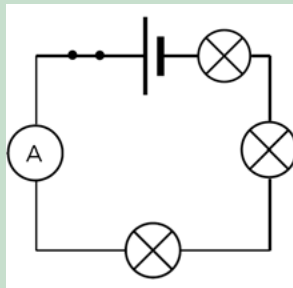

Circuit 3.

Record the ammeter readings in the following table:

Number of bulbs (resistors)	Ammeter reading (A)
1	
2	
3	

QUESTIONS:

1. What happened to the brightness of the bulbs and the ammeter reading as more light bulbs were added to the circuit?
The brightness of the bulbs decreased and so did the ammeter reading.
2. Explain the observations you made in question 1.
As the number of light bulbs increased, the resistance in the circuit increased. The increase in resistance caused the current to decrease.

If we increase the resistance in a series circuit, by adding more resistors, then the total current decreases. We say the current is inversely proportional to the resistance. We are now going to look at the potential difference of each resistor.





INVESTIGATION: Measuring the potential difference across components in a series circuit

TEACHER'S NOTE

This will have to be a demonstration if you do not have enough equipment for the learners to do this in small groups. If you have access to the internet, allow the learners to use the PhET simulations. Their results will also be more accurate as laboratory voltmeters might not be calibrated accurately enough.

INVESTIGATIVE QUESTION:

What is the relationship between the potential difference across the battery and the potential difference across the resistors in a series circuit?

MATERIALS AND APPARATUS:

- three 1,5 V cells
- insulated copper conducting wires with crocodile clips
- two resistors of different resistances
- three voltmeters
- a switch

TEACHER'S NOTE

If you do not have two different resistors, you can just use two light bulbs, but you will not then be able to make a direct comparison between potential difference and resistance if you do not know the resistances.

METHOD:

1. Construct a circuit with three 1,5 V cells, two resistors and the switch in series with each other.
2. Connect a voltmeter, in parallel, across the three cells. This is voltmeter V_1 .
3. Connect a second voltmeter, in parallel, across one resistor. This is voltmeter V_2 . Take note of whether this is the resistor with the higher or lower resistance.
4. Connect the third voltmeter, in parallel, across the other resistor. This is voltmeter V_3 . Take note of whether this is the resistor with the higher or lower resistance.
5. Record the readings on the 3 voltmeters.

TEACHER'S NOTE

If the learners are doing this investigation in small groups, make sure that their circuits are correct and that the voltmeters are connected in parallel.

RESULTS AND OBSERVATIONS:

Draw a circuit diagram to illustrate your circuit. Take note of which resistor has the highest resistance.

TEACHER'S NOTE

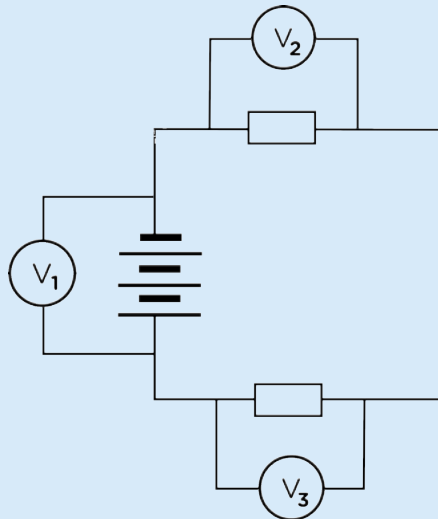

The orientation of the components in the circuit is not important. The battery can be drawn at the top, bottom or right hand side of the circuit diagram. It is important that the learners have used the correct symbols; that the resistors and cells are in series with each other and that the voltmeters are connected in parallel to the components they are measuring.

Reading on V_1 :

Reading on V_2 :

Reading on V_3 :

Record these readings on your circuit diagram above as well.

TEACHER'S NOTE

These readings will depend on the experimental set-up available in your school lab or on the PhET simulations. The trend should be that the readings on V_2 and V_3 add up to V_1 .

1. What do you notice about the readings on V_2 and V_3 when compared to V_1 ?
Learners responses may vary but they should notice that the readings on V_2 and V_3 are less than that on V_1 .
2. Add the readings on V_2 and V_3 together. What do you notice?
This answer will depend on the accuracy of the readings on the voltmeters. The learners should see that the sum of V_2 and V_3 is equal to the reading on V_1 (ie. $V_2 + V_3 = V_1$).

3. Which resistor has the highest potential difference, the one with the higher or lower resistance?

The resistor with the higher resistance has the higher potential difference across it.

CONCLUSIONS:

Write a conclusion for this investigation.

TEACHER'S NOTE

The total potential difference across the battery is equal to the sum of the potential differences across each of the resistors. A resistor with a higher resistance will have a higher potential difference.

What have we learnt? The **sum** of the potential differences across the resistors in a series circuit is equal to the potential difference across the battery.

If a resistor has a high resistance then it will have a large potential difference. If a resistor has a low resistance then it will have a small potential difference. We can explain this because the battery provides the electrons with potential energy. The electrons travel through the resistors and lose some of that energy to each resistor in the form of heat, light or sound. There is only one path for the electrons to travel and so they transfer energy to each resistor through which they pass. The higher the resistance of the resistor, the more energy is transferred within the resistor. Therefore, there will be a greater difference in potential energy per charge from before to after the resistor in the series circuit.

Let's look at the following example:

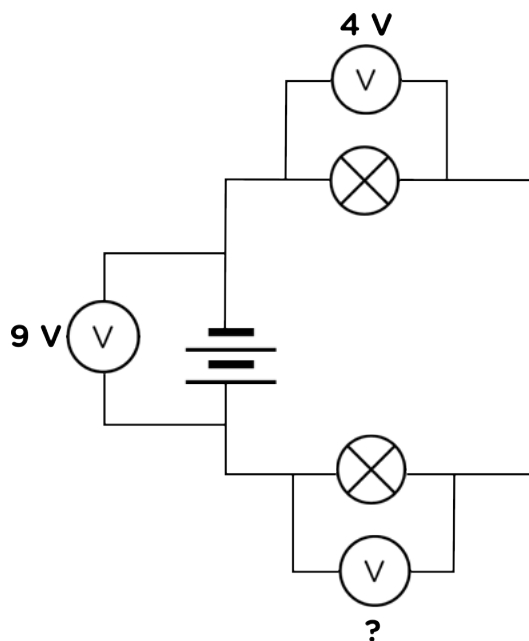

If the potential difference across the cells or battery is 9 V and the potential difference across one of the bulbs is 4 V, what would the reading on the third voltmeter be?

TEACHER'S NOTE

The potential differences across the two resistors must add together to give the potential difference across the battery. This means that the missing reading is $9 - 4 = 5 \text{ V}$.

We say that resistors in series are **potential dividers**.

ACTIVITY: Check your knowledge of series circuits

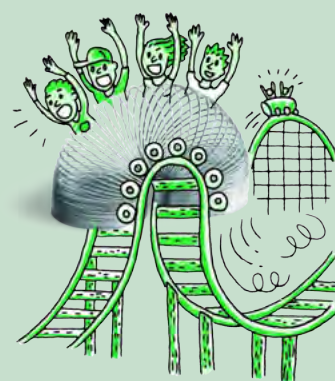

TEACHER'S NOTE

This activity will allow the learners to practice and test their understanding of the concepts they have learnt so far. Let each learner make their own predictions. If you have access to the PhET software, allow each learner to set up the circuits using PhET to test their predictions. If you do not have enough equipment to allow individual learners to build the circuits, either build one set of circuits to demonstrate to the class or allow them to work in small groups. If the learners are in groups, make sure that each learner gets a turn to build a circuit in order to make sure they have the skills to do so.

Learners should be left to make their own predictions without any help. This will also teach them the idea of making predictions (hypotheses) and testing them, the essence of scientific exploration. As a result the predictions will be learner-dependent.

MATERIALS:

- batteries (or cells)
- torch bulbs
- insulated copper conducting wires
- ammeters

INSTRUCTIONS:

Look at the circuit diagrams in the table. Assume that each bulb is the same.

1. Predict in which circuit each bulb will glow the brightest. On what did you base your prediction?
Learner-dependent answer.
2. Predict in which circuit each bulb will glow the dimmest. On what did you base your prediction?
Learner-dependent answer.
3. Why will the brightness of bulbs I, V and IX will be the same?
Learner-dependent answer.
4. Now test each of your prediction by building the different circuits. Include an ammeter in the circuits in order to measure the current.
Learner-dependent answer.

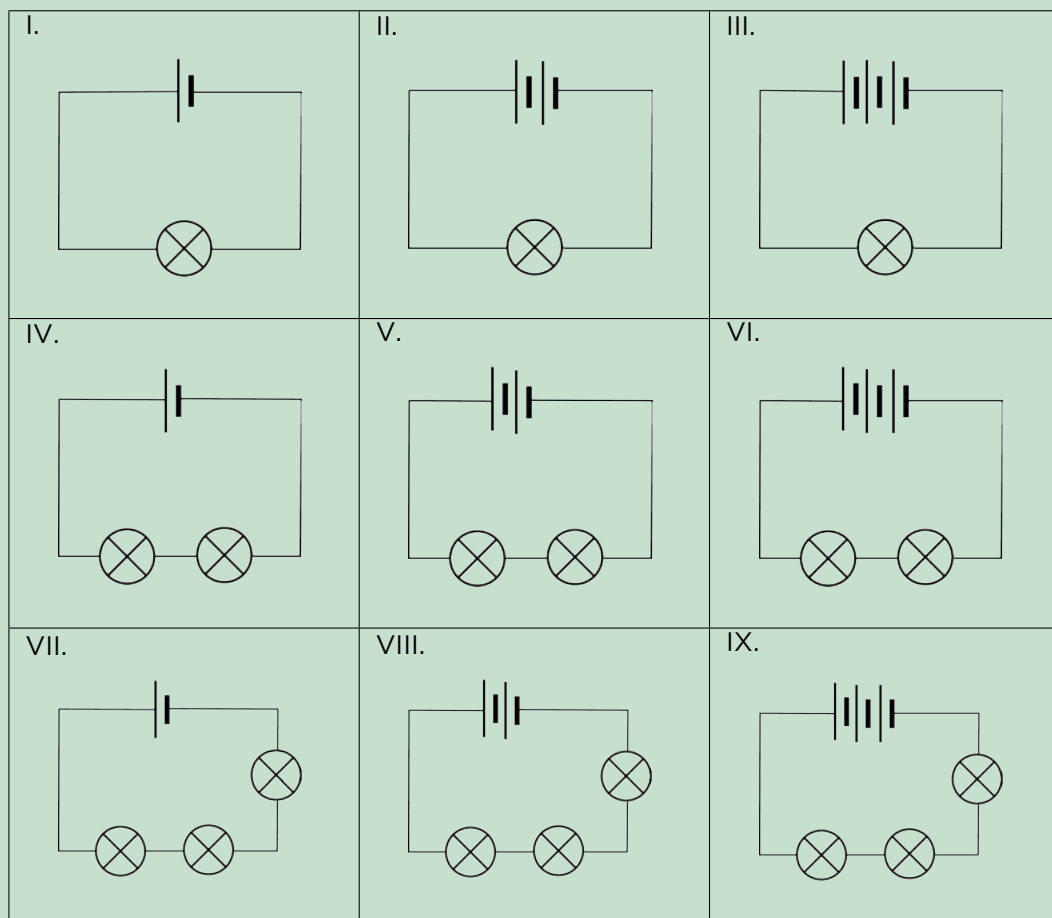

TEACHER'S NOTE

The brightest bulb should be in circuit III as it has the largest current with the least resistance. The dimmest bulb should be circuit VII as it has the smallest current with the largest resistance. The bulbs in circuits I, V and IX should be the same brightness if they are of the same resistance. Learners can test their predictions by setting up PhET simulations. Use the following website bit.ly/17vBMBX

We have now seen that the current is affected by adding more cells and resistors in series, but so far we have only measured the current at one point in the circuit. Let's see how the current compares at different points in the circuit.

ACTIVITY: Current in a series circuit

TEACHER'S NOTE

This is a revision activity as learners would have covered this in Gr. 8.

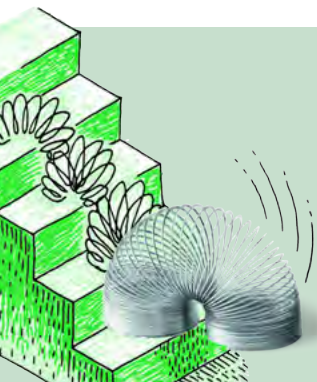

MATERIALS:

- insulated copper connecting wires
- two 1,5 V cells
- two torch light bulbs
- ammeter

INSTRUCTIONS:

1. Set up a series circuit with two cells and two torch light bulbs in series with each other.
2. Insert an ammeter in series between the positive terminal of the cells and the first torch bulb.
3. Measure the current strength using the ammeter. Draw a circuit diagram of this set-up.

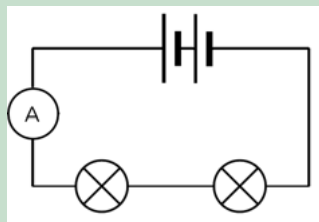

Circuit 1

4. Remove the ammeter and close the circuit again.
5. Insert the ammeter, in series, between the two torch bulbs.
6. Measure the current strength using the ammeter. Draw a circuit diagram of this set-up.

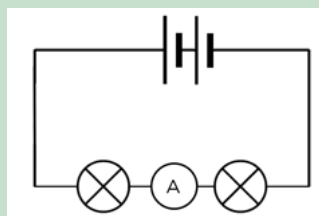

Circuit 2.

7. Remove the ammeter and close the circuit again.
8. Insert the ammeter, in series, between the last torch bulb and the negative terminal of the battery.
9. Measure the current strength using the ammeter. Draw a circuit diagram of this set up.

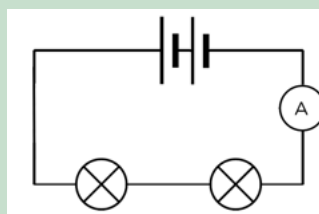

Circuit 3.

Complete the following table:

Position of ammeter in circuit	Ammeter reading (A)
Between positive terminal of battery and first bulb	
Between two bulbs	
Between negative terminal of battery and last bulb	

TEACHER'S NOTE

The ammeter readings should be the same at any point in the series circuit.

What can you conclude from this about the current in a series circuit?

TEACHER'S NOTE

The current strength is the same at any point in a series circuit.



VISIT
 Parallel circuits (video).
bit.ly/17bTRYp

4.2 Parallel circuits

A parallel circuit provides **more than one** path for the electric current to move through the circuit.

Parallel circuit	Draw a circuit diagram for this circuit

TEACHER'S NOTE

The circuit diagram should look as follows:

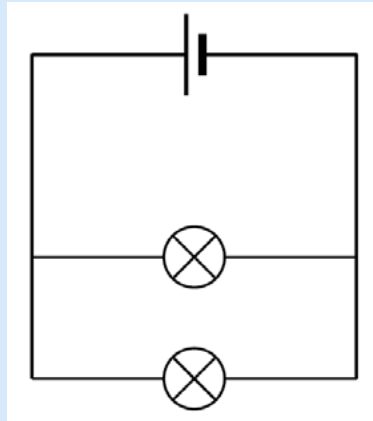

Cells in parallel

We saw that connecting cells in series increases the amount of energy supplied to the electrons. The potential difference increases. Let's investigate what happens when we add cells in parallel in a circuit.

INVESTIGATION: What happens to the current and potential difference in a circuit when adding cells in parallel?



TEACHER'S NOTE

If you do not have sufficient equipment to allow all the learners to attempt these circuits. Use the PhET simulation software which can be obtained from bit.ly/17vBMBX

HYPOTHESIS:

Write a hypothesis for this investigation.

TEACHER'S NOTE

A possible answer: Increasing the number of cells connected in parallel will increase the current and potential difference in the circuit.

Remember that the hypothesis does not have to be "correct", but it must just mention the variables that are to be investigated and the relationship which is expected to be observe.

MATERIALS AND APPARATUS:

- three 1,5 V cells
- insulated copper conducting wires with crocodile clips
- ammeter
- voltmeter
- resistor

METHOD:

1. Construct a series circuit with 1 cell and the ammeter in series.
2. Connect the voltmeter in parallel with the cell as shown in the circuit diagram.

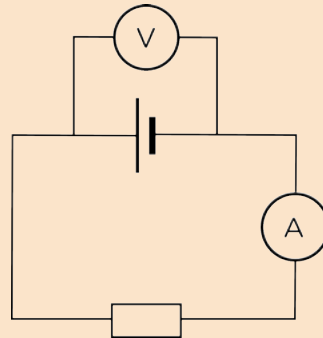

3. Record the readings in the table below.
4. Add a second cell in parallel with the first cell as shown in the diagram.

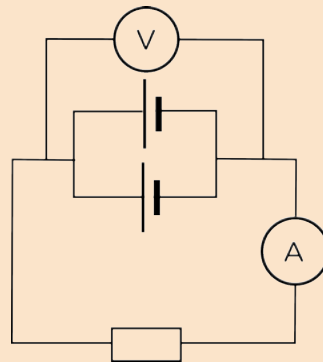

5. Record the new readings in the table below.
6. Add the third cell in parallel with the other two cells. Draw a circuit diagram for this in the space below.

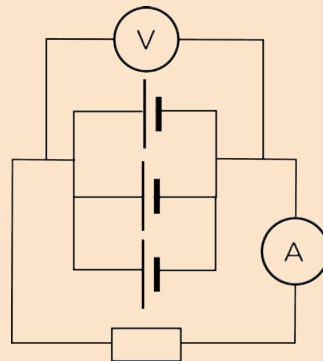

7. Record the new readings in the table below.

RESULTS:

Complete the following table:

Number of cells in parallel	Ammeter reading (A)	Voltmeter reading (V)
1		
2		
3		

CONCLUSION:

What can we conclude regarding the effect of adding cells in parallel into a circuit?

TEACHER'S NOTE

Connecting more cells in parallel into a circuit does not affect the current strength and the potential difference in the circuit.

What have we learnt? When we connect two cells in parallel with each other, the overall potential difference is the same as if we only had one cell. Therefore if both cells are 1,5 V, then the overall potential difference for the circuit is still 1,5 V. The current is the same as if there was only one cell because the electrons only travel through one of the cells.

What advantage would we get from connecting cells in this way? Discuss this with your class.

TEACHER'S NOTE

When we connect cells in parallel we supply alternative pathways for the current to follow. This means that each of the cells last longer than if they were in a series circuit. Also if one cell fails, the circuit will still have another cell.

Resistors in parallel

Parallel circuits have more than one pathway for the current. Let's look at how adding resistors in parallel affects the current strength.



ACTIVITY: Adding resistors in parallel

TEACHER'S NOTE

This activity is a revision of the investigation completed in Gr. 8. The learners might have forgotten what happens in a parallel circuit and it is worth repeating the activity.

MATERIALS:

- 1,5 V cell
- 3 torch bulbs
- insulated copper conducting wires
- switch
- ammeter

TEACHER'S NOTE

The switch and ammeter are not strictly necessary for this experiment. They can be left out if you do not have enough switches or ammeters.

INSTRUCTIONS :

1. Construct the circuit with the cell, ammeter, 1 bulb and the switch in series.
2. Close the switch.
3. Note how brightly the bulb is shining, write down the ammeter reading. Draw a circuit diagram of your circuit.

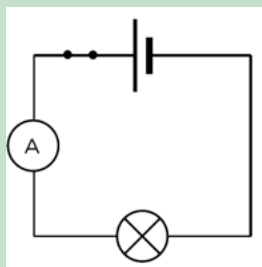

4. Open the switch.
5. Add another light bulb, in parallel to the first, into the circuit.
6. Close the switch.
7. Note how brightly the bulbs are shining and write down the ammeter reading. Draw a circuit diagram of your circuit.

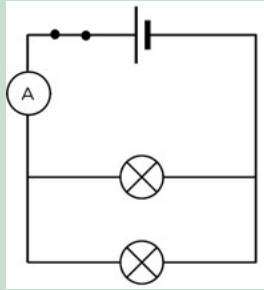

8. Open the switch.
9. Add the third light bulb, in a parallel to the first two, into the circuit.
10. Close the switch.
11. Note how brightly the bulbs are shining and write down the ammeter reading. Draw a circuit diagram of your circuit.

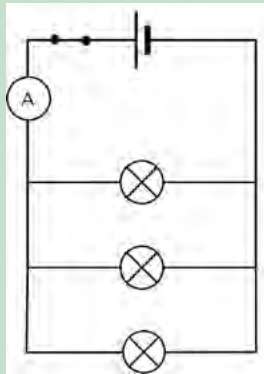

QUESTIONS:

1. What happened to the brightness of the bulbs and the ammeter reading as more light bulbs were added in parallel?
The brightness increased and so did the ammeter reading.
2. Explain your observations from question 1.
As more resistors were added in parallel, the resistance of the circuit decreased as the current is provided with alternative pathways, and the current increases with each resistor in parallel.

In the last activity, we only measured the current in the main branch of the circuit. What happens to the current in a parallel circuit?

ACTIVITY: Current in a parallel circuit

TEACHER'S NOTE

This is also a revision activity of what learners covered in Gr. 8.



MATERIALS:

- insulated copper connecting wires
- two 1,5 V cells
- three identical torch light bulbs
- ammeter

METHOD:

1. Set up a parallel circuit with two cells in series with each other and three torch light bulbs in parallel with each other.
2. Insert an ammeter in series between the cells and the first pathway as shown in the diagram.

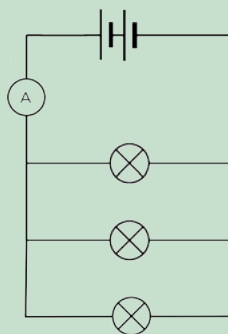

3. Measure the current strength using the ammeter.
4. Remove the ammeter and close the circuit again. Insert the ammeter, in series, in the first pathway.

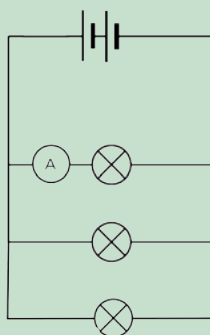

5. Measure the current strength using the ammeter.
6. Insert the ammeter, in series, in the second pathway.

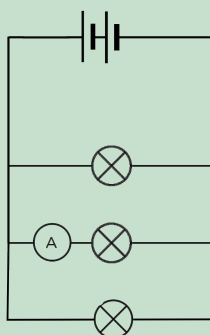

7. Measure the current strength using the ammeter.
8. Insert the ammeter, in series, in the third pathway.

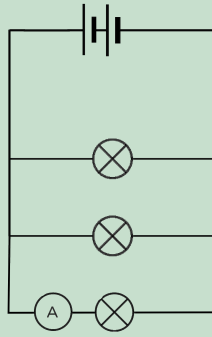

9. Measure the current strength using the ammeter.
10. Insert the ammeter, in series, between the first pathway and the batteries on the opposite side to the first reading.

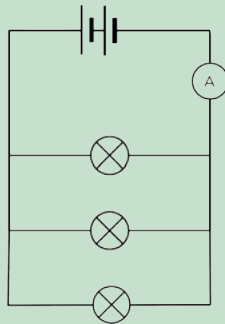

11. Measure the current strength using the ammeter.
- Draw a table in the following space to record your readings.

TEACHER'S NOTE

An example table is:

Table showing the ammeter readings at different positions in a parallel circuit.

Position of ammeter in circuit	Ammeter reading (A)
between the cells and first pathway	
in the first pathway	
in the second pathway	
in the third pathway	
between the first pathway and the cells	

QUESTIONS:

1. What do you notice about the current in the main branch and the current in the pathways?
The current in the main branch is bigger than the current in each pathway.

2. Add up the currents in each pathway through a bulb. What do you notice?
Learners should note that the currents in each pathway through the bulbs add up to the total current.
3. Use the following diagram and write an equation to illustrate the relationship between:

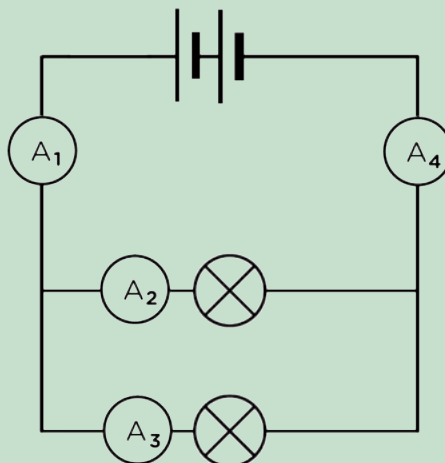

- a) A1 and A4.
 - b) A1, A2 and A3.
 - c) A4, A2 and A3.
- a) $A_1 = A_4$
 - b) $A_1 = A_2 + A_3$
 - c) $A_4 = A_2 + A_3$



When we add resistors in parallel to each other the total resistance decreases and the current increases. Why does this happen? Adding resistors in parallel provides more alternative pathways for the current. Therefore it is easier for current to move through the circuit than if all the current had to move through one resistor.

Imagine that you are sitting in a school hall during assembly. You are bored and waiting for the end so that you can go out to break to chat to your friends. There is only one exit from the hall. When you are dismissed, everyone has to exit through the same door. It takes a while because only some learners can leave at a time.

Now imagine that there is a second door that is the same as the first door. Now you and your friends have a choice of which door to go through. The number of learners that exit the hall together will increase and some of you will exit through the first door while others will exit through the second door. No one can go through both doors at the same time.

This is similar to the way current behaves when in a parallel circuit. As the electrons approach the branch in the circuit, some electrons will take the first path and others will take the other path. The current is divided between the two pathways. We say that resistors in parallel are current dividers. Although both pathways provide resistance, the total resistance is less than if there was just one pathway.

We are now going to look at the potential difference across each resistor in a parallel circuit.

VISIT

Water flow analogy: series and parallel circuits (video).

bit.ly/19nWOCB

INVESTIGATION: Measuring the potential difference across components in a parallel circuit

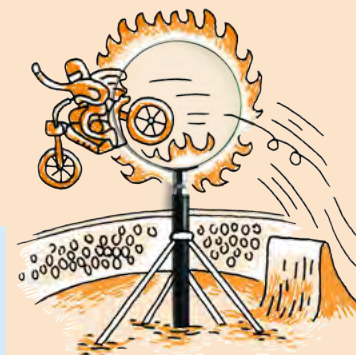

TEACHER'S NOTE

If you do not have sufficient equipment to allow all the learners to attempt these circuits. Use the PhET simulation software which can be obtained from bit.ly/17vBMBX

It would be sensible to use PhET simulations for this investigation due to the large amount of equipment required. If you do not have access to the PhET simulations then it would be a good idea to do this as a demonstration.

INVESTIGATIVE QUESTION:

What is the relationship between the potential difference across the battery and the potential difference across the resistors in a parallel circuit?

HYPOTHESIS:

Write a hypothesis for this investigation.

TEACHER'S NOTE

This is learner dependent. The learners must state the relationship that they expect to see between the potential difference across the individual resistors and the potential difference across the battery. An example could be: The potential difference across each resistor is equal to the potential difference across the battery.

MATERIALS AND APPARATUS

- three 1,5 V cells
- insulated copper conducting wires with crocodile clips
- two torch light bulbs or resistors
- three voltmeters
- a switch
- 3 ammeters

TEACHER'S NOTE

You should use light bulbs or resistors of different strengths to demonstrate that the potential difference across each is still the same when they are connected in parallel.

METHOD

Construct the following circuit:

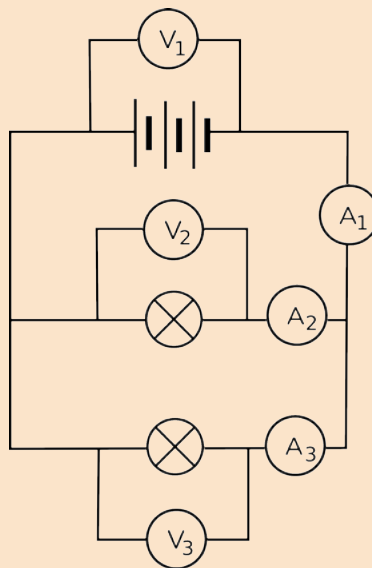

TEACHER'S NOTE

If the learners are doing this investigation in small groups, make sure that their circuits are correct and that the voltmeters are connected in parallel.

Note the readings on the 3 voltmeters and ammeters.

RESULTS:

Record the readings here in the table and write them onto the circuit diagram above:

Voltmeter	Reading (V)	Ammeter	Reading (A)
V ₁		A ₁	
V ₂		A ₂	
V ₃		A ₃	

TEACHER'S NOTE

These readings will depend on the experimental setup available in your school lab or on the PhET simulations. The trend should be that the readings on V₂ and V₃ and V₁ are equal and that A₂ and A₃ add up to A₁.

1. What do you notice about the readings on V₂ and V₃ when compared to V₁?
Learners responses may vary but they should notice that the readings on V₁, V₂ and V₃ are equal.

2. Add the readings on A_2 and A_3 together. What do you notice?
This answer will depend on the accuracy of the readings on the ammeters. The learners should see that the sum of A_2 and A_3 is equal to the reading on A_1 .
3. Explain the behaviour of the electrons in the circuit based on the ammeter readings.
The electrons have more than one path to follow and so some travel through the first path and the rest travel through the second path. All of the electrons travel through A_1 .

CONCLUSION:

Write a conclusion for this investigation based on the investigative question.

TEACHER'S NOTE

The potential difference is the same across the battery and each resistor in parallel in a parallel circuit.

Extension:

TEACHER'S NOTE

This is an extension to do some calculations which is not required at this level. However, they are very simple equations and also highlights to learners that one can calculate the resistance. It is also important that learners realise that they will do many calculations in Gr. 10-12 should they carry on with Physical Sciences.

The video listed in the **Visit** box on 'Voltage, current and resistance' provides a clear explanation of the relationship between these concepts. The video also makes use of the PhET simulation to build electric circuits, available at this link: ⁴ bit.ly/1gqqT1a Watch the video to get a sense of how to use simulations in your classroom to explain and teach concepts.

Do you know that we can calculate the resistance of each light bulb in the circuit used in this investigation? We have seen that the current (I) through a resistor is inversely proportional to the resistance (R) and the potential difference across a resistor (V) is directly proportional to the resistance.

This relationship is summarised in the following equation:

$$R = \frac{V}{I}$$

The unit of resistance is the ohm (Ω) which is defined as a volt per amp of current. This can be written as:

$$1 \text{ ohm} = 1 \frac{\text{volt}}{\text{amp}}$$

VISIT

Voltage, current and resistance. bit.ly/1b7ggTC

We can therefore calculate the resistance. An example is shown here using the values in this circuit diagram:

$$R = \frac{V}{I}$$

$$= \frac{3 \text{ V}}{2 \text{ A}}$$

$$= 1.5 \Omega$$

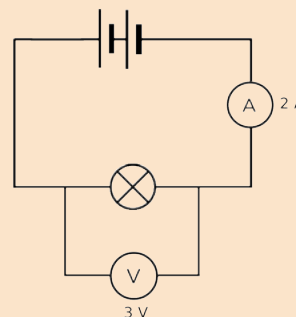

In this investigation, you measured the potential difference (in volts) and the current (in amps) for each bulb. Use these measurements to calculate the resistance for each bulb in your circuit.

TEACHER'S NOTE

Resistance of bulb 1 = V_2/A_2

Resistance of bulb 2 = V_3/A_3

What have we learnt from this investigation?

- The current in a parallel circuit divides when it enters the separate branches. The total current is the sum of the current in the branches.
- The potential difference across the branches of the circuit is the same as the potential difference across the battery.

ACTIVITY: Series and parallel circuits

TEACHER'S NOTE

This activity will show the learners the advantage of using a parallel circuit in a household circuit. When one light bulb is removed from a series circuit, the single pathway is broken and current no longer moves through the circuit. When one light bulb is removed from a parallel circuit, there is still a complete pathway for the current to move through and so the other light bulbs still function.

If you do not have sufficient equipment to allow all the learners to attempt these circuits. Use the PhET simulation software which can be obtained from ⁵ bit.ly/17vBMBX

MATERIALS:

- two 1,5 V cells
- insulated copper conducting wires
- two torch light bulbs

INSTRUCTIONS:

1. Set up a series circuit with the two cells and the two torch light bulbs. Are both torch lights shining?
Both torch lights are shining.
2. Disconnect one of the torch light bulbs. What happens?
Both torch lights are no longer shining.
3. Set up a parallel circuit with two cells and the two torch light bulbs in parallel with each other. Are both torch lights shining?
Both torch lights are shining.
4. Disconnect one of the torch light bulbs. What do you notice?
The torch light bulb left in the circuit is still shining.

QUESTIONS:

1. Why did the series circuit stop working when one of the light bulbs was removed?
The single pathway in the series circuit was broken by the removal of the light bulb. This means that current can no longer move through the circuit and it stops working.
2. Why did the light bulb in the parallel circuit keep shining after you removed the other bulb?
One of the pathways was broken by the removal of the light bulb but the other pathway provided an alternative for the current to travel through.
3. Which type of circuit, series or parallel would be more useful in a household circuit? Why?
The parallel circuit would be more useful because light bulbs often break or fuse. If we use a parallel circuit, the rest of the light bulbs and appliances in the house can still function. If we use a series circuit then one broken appliance would mean that everything stops working.



Parallel circuits are useful in household circuits because if one pathway stops working then the other pathways can still work. So if your bathroom light bulb breaks, the rest of the lights or appliances in the house can still be used. If your house used a series circuit then all the lights and appliances in the house would stop working if one item broke. You can also turn lights on in different rooms at different times without having to turn all the lights on in the whole house at once.

An example of a series circuit is a set of tree lights. Each light bulb is connected in series with the others. This means that if even one breaks then all will stop working. To find the broken one and fix it, you would have to test every bulb.



Tree lights are sometimes connected in series.

VISIT

Series and parallel circuits
(video). bit.ly/1a7zvht



SUMMARY:

Key Concepts

- A series circuit provides only one pathway for the electrons to move through the circuit.
- Increasing the number of cells connected in series, increases both the current strength through the circuit and the potential difference across the cells.
- Increasing the number of resistors in a series circuit increases the overall resistance of the circuit.
- Resistors connected in series are potential dividers. The sum of the potential differences of the resistors is equal to the potential difference of the battery.
- The current strength in a series circuit is the same throughout the entire circuit.
- A parallel circuit provides more than one pathway for the electrons to move through the circuit.
- Increasing the number of cells connected in parallel with each other has no effect on the current strength and the potential difference of the circuit.
- Increasing the number of resistors connected in parallel decreases the overall resistance of the circuit.
- Resistors connected in parallel are current dividers. The current has more than one pathway to move along and so the current divides between the paths. The sum of the current strengths in the pathways is equal to the current strength before and after the branch in the pathway.
- The potential difference across each pathway is equal to the potential difference across the battery.
- Parallel circuits are used in the lighting systems in buildings.

Concept Map

Complete the concept map on the next page. Remember that you can also add in your own notes on this page to make your summary more comprehensive and easier for you to study from for tests and exams.

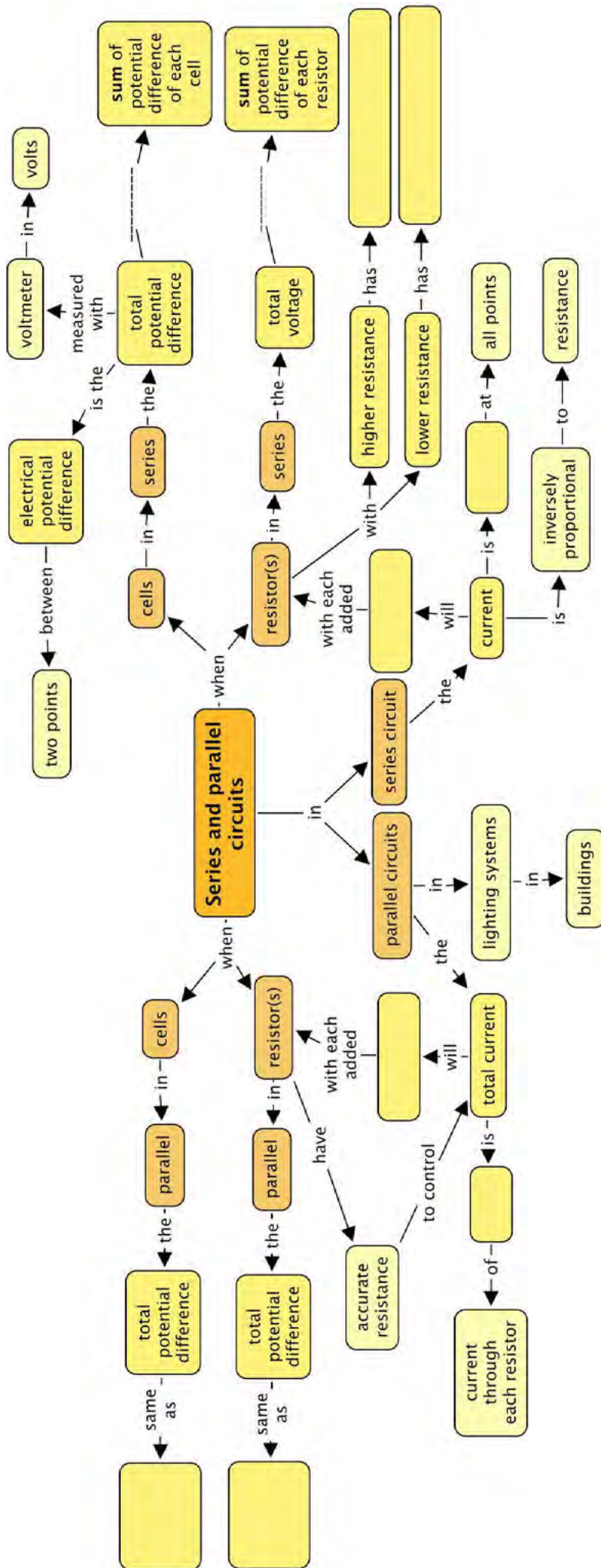

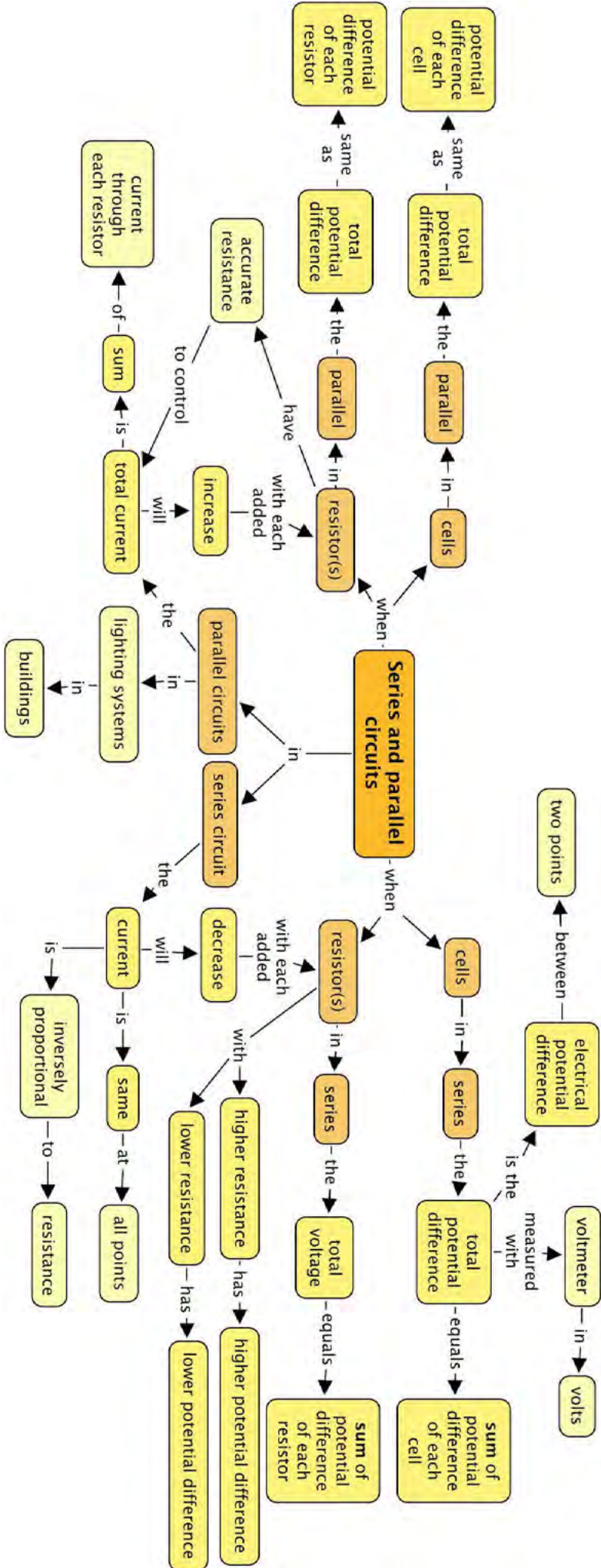

REVISION:

1. Draw the following circuit diagrams.
 - a) A closed circuit with one cell, two light bulbs and a switch in series. [2 marks]
 - b) An open circuit with two cells, two light bulbs and a switch in series. [2 marks]
 - c) A closed circuit with 1 cell and a resistor in series, with an ammeter to measure the current and a voltmeter to measure the potential difference of the cell. [2 marks]
 - d) A closed circuit with two cells in series and two light bulbs in parallel. [2 marks]
 - e) A closed circuit with an ammeter and resistor in series and three cells in parallel, with a voltmeter connected to measure the potential difference across the three cells. [2 marks]

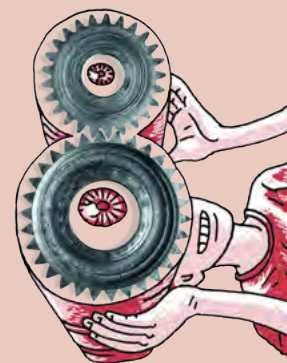
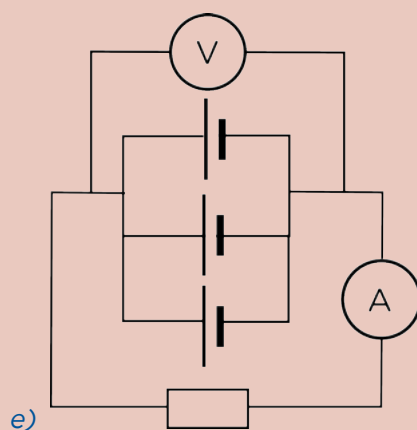
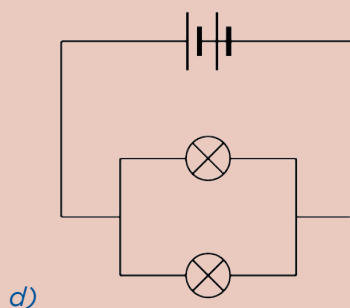
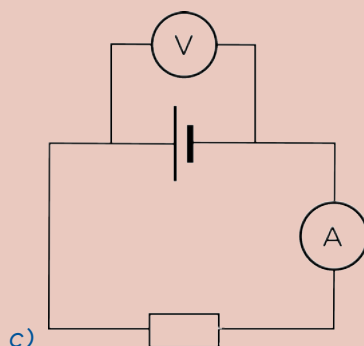
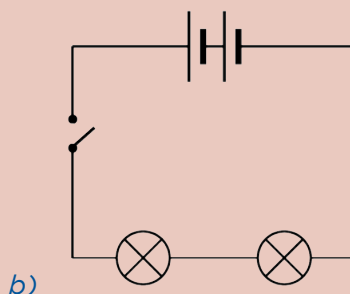
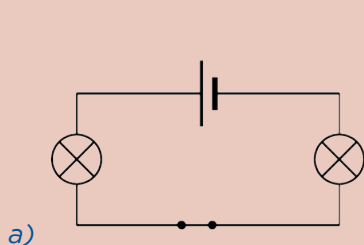

2. Look at the following circuit diagram. Identify the number of bulbs, switches and cells in this circuit. Identify whether they are in series or parallel. [3 marks]

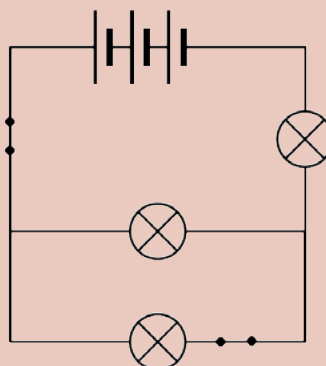

There are 3 cells in series with 1 bulb and a switch, there are two bulbs in parallel and a switch in series with one bulb.

3. Ian has bought a string of Christmas tree lights and has hung them in the tree and plugs them in. One of the light bulbs breaks.
- What happens to the rest of the light bulbs? [1 mark]
 - Explain your answer to question a. [2 marks]
- a) The rest of the light bulbs stop working.
b) The light bulbs are connected in series with each other. If one breaks then the circuit is broken and no current moves through the circuit.*
4. Household circuits are parallel circuits. Explain why it is better to use a parallel circuit in a house than a series circuit? [2 marks]
- This enables you to switch one light on in a room without turning all the lights on. If one part of the parallel circuit breaks then the rest of the circuit can still function as the other pathways are still complete.*
5. Answer the following questions on the circuit below.

Circuit	Values for each reading [2 marks]
	$A_1 = 3 \text{ A}$ $A_2 =$

- Work out the missing values.
- Explain your answer above. [1 mark]

a) $A_2 = 3 \text{ A}$

NOTE: *There are many different possible variations on the diagrams in this question. You can change the values or the layout of the circuits in order to give extra practice to any learners that are struggling with this concept.*

b) The current is the same at all points in a series circuit.

6. Answer the following questions on the circuit below.

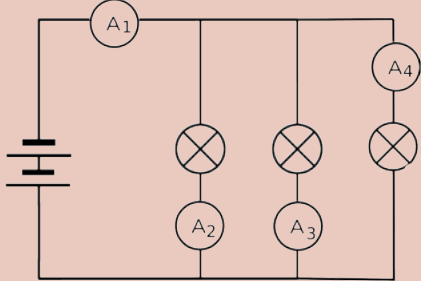
Circuit	Values for each reading [2 marks]
	<p> $A_1 =$ $A_2 = 3A$ $A_3 = 3A$ $A_4 = 1A$ </p>

- Work out the missing values.
- Explain your answer above. [2 marks]

- $A_1 = 7 A$
- The current in a series circuits splits through each parallel branch such that the total current in the main circuit is equal to the sum of the currents in each branch.*

7. Answer the following questions about the circuit below.

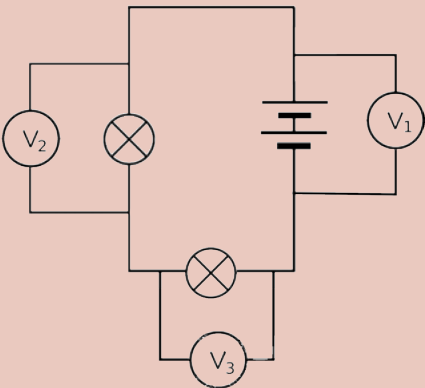
Circuit	Values for each reading [2 marks]
	<p> $V_1 = 12 V$ $V_2 = 8 V$ $V_3 =$ </p>

- Work out the missing values.
- Explain your answer above. [2 mark]

- $V_3 = 4 A$
- The potential differences across the battery in a series circuit is equal to the sum of the potential differences across each resistor.*

8. Answer the following questions about the circuit below.

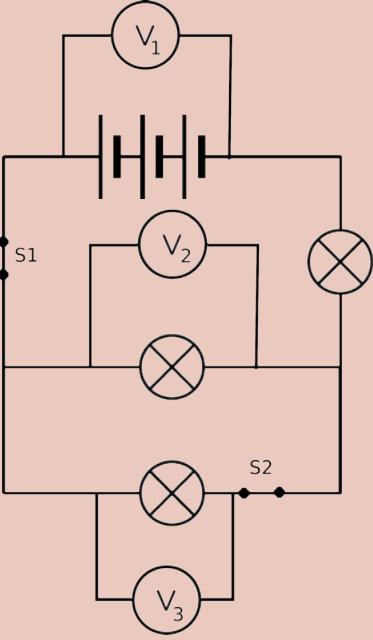
Circuit	Values for each reading [2 marks]
	<p> $V_1 = 10 \text{ V}$ $V_2 =$ $V_3 =$ </p>

- Work out the missing values.
- Explain your answer above. [1 mark]
- How many bulbs will still glow if switch S1 is opened? [1 mark]
- How many bulbs will still glow if switch S2 is opened? [1 mark]

- V_2 and $V_3 = 10 \text{ V}$.
- The potential difference across the battery in a parallel circuit is equal to the potential difference across each resistor in parallel.
- No bulbs will glow.
- Two bulbs will glow.

9. Work out the missing values below.

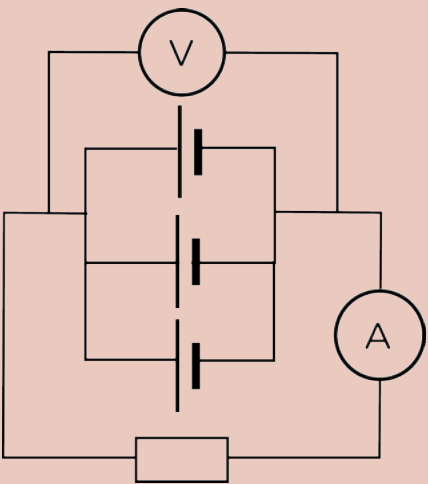
Circuit	Values for each reading [2 marks]
	<p>Each cell in this circuit is 1,5 V. What is the reading on V?</p>

The value is 1.5 V.

10. Answer the following questions about the circuit below.

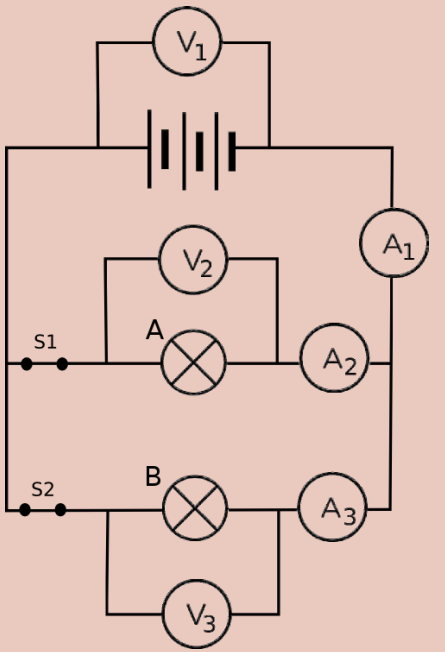
Circuit	Values for each reading [4 marks]
	<p> $V_1 = 9 \text{ V}$ $V_2 =$ $V_3 =$ $A_1 = 6 \text{ A}$ $A_2 = 2 \text{ A}$ $A_3 =$ </p>

- Work out the missing values.
- What would the reading on A2 show if switch S2 is opened? [2 marks]
- Explain your answer to the previous question. [2 marks]
- Which bulb, A or B, has the higher resistance? [2 marks]
- Explain your answer to the previous question. [2 marks]
- Extension question:** Calculate the resistance of Bulb A and Bulb B. Show your working in the space below. [4 marks]

- V_2 and $V_3 = 9 \text{ V}$.
 $A_3 = 4 \text{ A}$.
- It would show 6 A.
- When switch S2 is opened, the circuit becomes a series circuit and all the current goes through the one branch, through A2 and so A1 and A2 will show the same reading, 6 A.
- Bulb A has the higher resistance.
- Bulb A has the smaller current which goes through it, and therefore it must have the higher resistance as the larger the resistance, the smaller the current (they are inversely proportional).
- This is an extension question as it is not required to be able to calculate resistance. An example was covered in the content.
Resistance in Bulb A = $V/I = 9/2 = 4.5 \Omega$
resistance in Bulb B = $V/I = 9/4 = 2.25 \Omega$

Total without extension [48 marks]

Total with extension [52 marks]



The possibilities for cogs are endless. Discover more!





TEACHER'S NOTE**Chapter overview**

0.5 weeks

This is a short chapter on safety practices and devices associated with electricity. It is important that learners understand the dangers associated with electricity and how accidents and faults can be avoided.

Learners are introduced to various safety devices which are commonly used in appliances and circuitry in order to reduce the risk of electric shocks. Many of these safety devices will be unfamiliar to the learners as they are inside electrical appliances and not seen. It is very important that all learners are able to safely connect a three-pin plug because short circuits can be caused by faulty wiring of plugs.

CAPS dedicates half a week (1.5 hours) to this chapter. However, there are several activities which are worth doing, and also suggested in CAPS. A recommendation is to spend slightly more time than is allocated in CAPS on this chapter, and slightly less time on Chapter 7 on the 'Cost of electrical power' as this chapter does not actually need 2 weeks to teach.

A suggestion is to invite in a certified electrician to share case studies of dangers of faulty electricity and discuss briefly the legislation regarding certifying a house before selling it.

5.1 Safety practices (1 hour)

Tasks	Skills	Recommendation
Activity: Making your own fuse	Demonstration, following instructions, observing, describing, drawing, explaining,	Suggested
Activity: Drawing circuit diagrams with fuses	Accessing and recalling information, communicating (graphically)	CAPS suggested
Activity: Wiring a 3-pin plug	Following instructions, observing, recording, describing	CAPS suggested
Activity: Wiring a house	Accessing and recalling information, communicating (graphically)	CAPS suggested

5.2 Illegal connections (0.5 hours)

Tasks	Skills	Recommendation
Activity: Case study on illegal electricity connections	Accessing and recalling information, interpreting, explaining	Suggested

KEY QUESTIONS:

- How safe is my electricity connection?
- What is a short circuit?
- Why do plugs have three wires?

5.1 Safety practices

Imagine you are at home, it is dark and you have switched on one of the overhead lights. You then switch on a second light. Does the first light become dimmer? No, it does not. This is because the electrical circuits in houses are parallel circuits.

Why do we use parallel circuits in a house? Do you remember the activities you did in the previous chapter? You saw that a series circuit stops working if one part of it breaks, but a parallel circuit does not. If one of the branches of the parallel circuit stops working, there are still complete pathways for the current and so the rest of the circuit can still function. This also enables you to switch on different lights and plugs in a house at different times.

We also saw that adding resistors to a series circuit increases the total resistance of the circuit, causing the current to decrease. In a parallel circuit, adding resistors does not increase the overall resistance and so the current does not decrease.

Despite the advantages of using parallel circuits in the electrical wiring in buildings, there is a disadvantage. Parallel circuits can become overloaded with too many branches and become a safety hazard. The overloading can cause too much heat which could lead to a fire starting. The fire would spread throughout the house and cause a lot of damage.

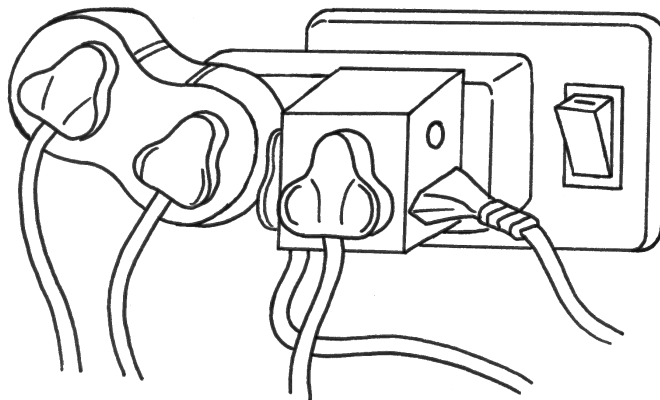

This plug is overloaded and is a safety hazard.

Let's now look at some of the safety practices which are followed and employed.

Earthing

What does it mean to **earth** an electrical appliance? Let's consider the example of a washing machine.



VISIT

Safety Dog provides some useful safety tips in this short video. bit.ly/1c04vmZ

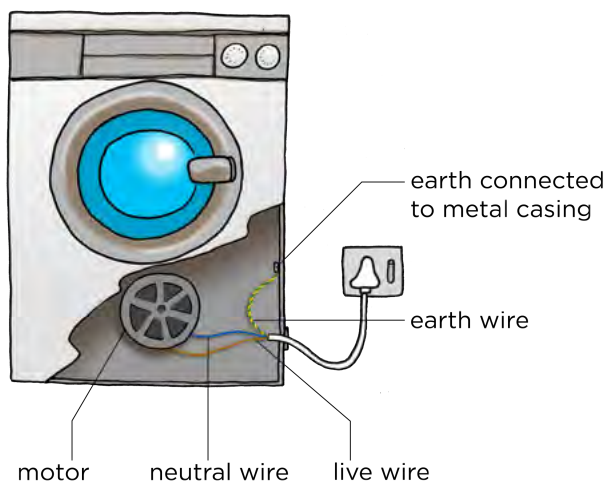
**TAKE NOTE**

The earth wire is sometime just green or just yellow instead of striped.

The electric circuit inside the washing machine has three different wires:

- a brown **live wire**
- a blue **neutral wire**
- a green and yellow striped **earth wire**

The live and neutral wires provide the potential difference needed for the motor inside the washing machine to turn. The earth wire is connected to the metal case of the washing machine. The three wires are encased in a plastic insulation to form one cord which is plugged into the mains electricity supply at the wall. The earth wires from all the electric sockets end up in one thick earth wire which is connected to a big metal spike driven into the ground.

The earth wire usually does nothing. The only time it is used is when something goes wrong inside the machine. If the live wire is exposed and touches the metal casing of the washing machine, you could get an electric shock if you then touch the metal casing. However, the earth wire is connected to the metal casing so that the current goes through the earth wire and into the ground instead of shocking you. The earth wire has a very low resistance and so a strong current will easily go through it.

The earth wire completes the circuit and connects the live wire to the ground. This is a **short circuit**. The washing machine will stop working because none of the electricity will flow through the motor.

If there was no earth wire then the metal casing of the washing machine would become part of the electrical circuit and anyone who touched it would get an electrical shock. That is why an earth wire is an important safety feature on any electrical appliance.



The green and yellow earth wire connected to the metal casing inside an electric motor.

What are short circuits? A short circuit usually happens by mistake. An extra electrical pathway is made. The extra electrical pathway has very low resistance and so the current increases. This increased current can damage appliances and cause overheating. Overheating can lead to fires. There are several safety devices which are used to stop the flow of current if a short circuit occurs. Let's look at some of the safety devices which are commonly used.

VISIT

How to deal with an electrical shock from an appliance. bit.ly/1c9pGDg

ACTIVITY: Making your own fuse

TEACHER'S NOTE

This is a simple way to demonstrate how a fuse works. Learners will make a small fuse from steel wool. Make sure that you use a heat resistant tile or block under the fuse because it will become hot and burn up. An old ceramic tile or piece of wood would work best.

Fuses are a practical application of the heating effect of an electric current. If you have enough equipment you could allow small groups of learners to complete this activity. Otherwise, use it as a demonstration.

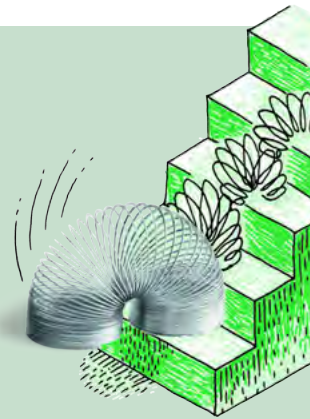

MATERIALS:

TEACHER'S NOTE

The light bulb is included to show that the current is flowing while the steel wool is in place but not flowing when the steel wool melts. The variable resistor is used to show that when the resistance is high, the current is low enough that the fuse warms up but doesn't melt. When the resistance is lowered, the current speeds up until it melts the steel wool.

If you are demonstrating and you want to make the activity more exciting then you can use a small ball of steel wool instead of a wire. This should make the steel wool spark and burn. This should be done behind a screen as the sparks could land on a learner.

If you do not have a variable resistor then leave it out of the circuit and rather explain the concept. An ammeter is also not crucial in doing this activity as the light bulb can be used to indicate whether there is current or not.

- three 1,5 V cells (large voltage battery)
- copper conducting wires with crocodile clips
- steel wool
- heat resistant mat or piece of wood
- torch light bulb
- variable resistor
- ammeter

INSTRUCTIONS

1. Set up a circuit according to the following picture.

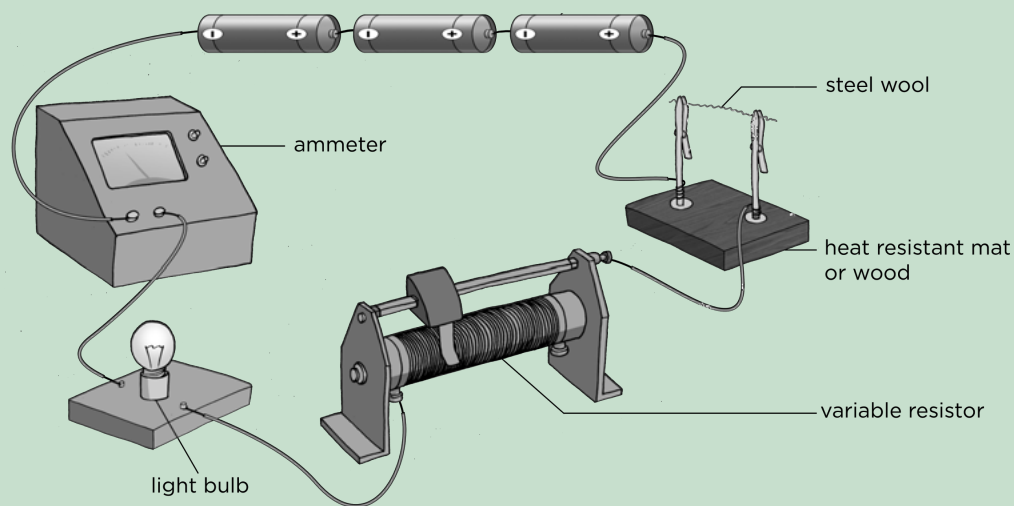

2. Twist a few strands of steel wool into a wire. This must not be very thick. Just a few strands will do.
3. Use the steel wool to complete the circuit.
4. Set the variable resistor to its highest resistance.
5. Close the switch. What do you observe?
The light bulb should glow and the steel wool should warm up but not melt.
6. Take note of the reading on the ammeter which measures the current in the circuit.
7. Open the switch.
8. Set the variable resistance to its lowest resistance.
9. Close the switch. What do you observe?
The steel wool melts/burns and breaks up and the light bulb stops glowing.

QUESTIONS:

1. Draw a circuit diagram for your circuit.

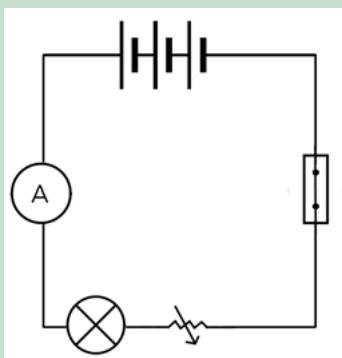

2. Why is the light bulb included in the circuit?

The light bulb is a good indicator of whether or not there is a current in the circuit. If the light bulb glows it means there is electric current. If the light does not glow it means that there is no current (or there is a very small current).

NOTE: *Sometimes though there might still be a very small electric current, but it does not provide enough energy to cause the light bulb to glow. This is why the light bulb gives a good indication, but an ammeter will provide the most definitive indication of whether there is a current or not.*

3. When you decreased the resistance, what happened to the current? In other words, what happened to the reading on the ammeter?

The current increases when the resistance decreased. The ammeter reading increases.

4. What do you think happens to the electric current when the steel wool has burnt? Explain your answer.

The current stops because the circuit has been broken. There is no longer a complete pathway for the electrons to move.



A fuse is a wire which will melt if the current travelling through becomes too large due to a fault, such as a short circuit or overload. When the fuse wire melts it breaks the circuit and current stops flowing. This disconnects the appliance to prevent any further damage. Fuses are stamped with the maximum current that they can handle. The photo is of a 5 ampere fuse. It will melt if a current of more than 5 amperes passes through it.

Motor cars also have fuses. Can you see the fuse in this photo showing the battery in a motor car?



A 5 ampere fuse.



ACTIVITY: Drawing circuit diagrams with fuses

INSTRUCTIONS:

Draw the following circuit diagrams to show various places to insert fuses in circuits.

1. A circuit diagram with two batteries and two light bulbs in series with each other. Insert a fuse into the circuit so that if the fuse breaks all the light bulbs will switch off.

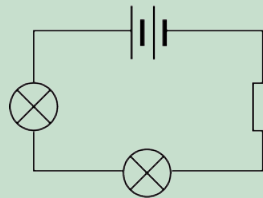

2. A circuit diagram with a cell and two light bulbs in parallel with each other. Insert a fuse into the circuit so that if the fuse breaks, only one of the light bulbs will switch off.

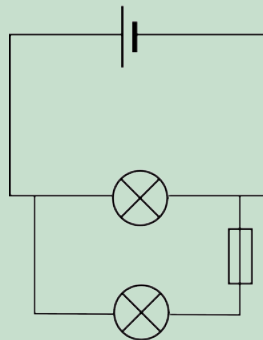

3. A circuit diagram with a cell and two light bulbs in parallel with each other. Insert a fuse into the circuit so that if the fuse breaks, both bulbs will switch off.

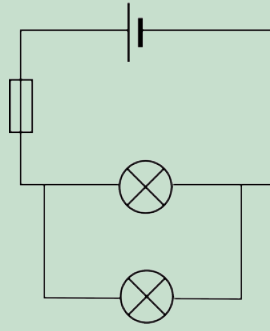

When a fuse melts, it has to be replaced each time. There are other devices which are now more commonly used in households rather than fuses, such as circuit breakers.



This fuse has blown and has to be replaced.

Circuit breakers

Circuit breakers are one of the most important safety devices in our homes today. Without circuit breakers, electricity in our houses and buildings could be dangerous due to the risk of fires and other safety hazards resulting from electrical wiring faults and equipment failures.

A circuit breaker is similar to a fuse except that it can be reset. Once a fuse has melted it is thrown away and a new fuse is put into the circuit. A circuit breaker acts in the same way that a switch would and breaks the circuit if the current surges. You may have seen these switches before on a circuit or distribution board in your home or school.

TEACHER'S NOTE

A good idea is to identify the circuit/distribution board in your school and take learners to see it so that they can see the switches.



An example of circuit breakers showing the switches.

TAKE NOTE

If you want to revise some concepts from previous grades, remember that you can visit

www.curious.org.za to see all Gr 7 to 9 content.

Discover more online!

Let's take a look at how a circuit breaker functions. Do you remember learning about electromagnets in Gr 8 when we looked at the effects of an electric current? An electromagnet is a type of magnet which forms due to an electric current around a bar. The strength of the magnet depends on the electric current. The more current, the stronger the magnet.

A basic circuit breaker consists of a switch connected to an electromagnet. Have a look at the following diagram.

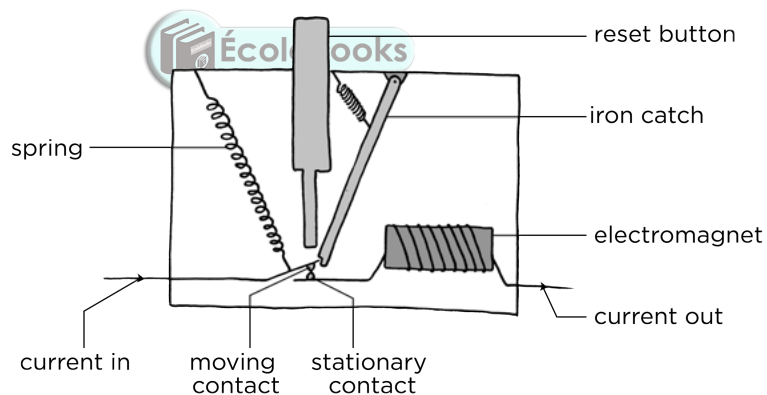

When the switch is on, the current flows through the device, from the left through the moving contact and across to the stationary contact. It then goes around the electromagnet and out the other side. The iron catch is holding the moving contact in place so that the circuit is complete. If the current passing through the circuit breaker increases, the electromagnet becomes stronger. If the current gets to unsafe levels, the electromagnet becomes strong enough to pull the iron catch lever. This releases the moving contact so that the circuit breaks and the electricity is shut off, as shown in the following diagram.

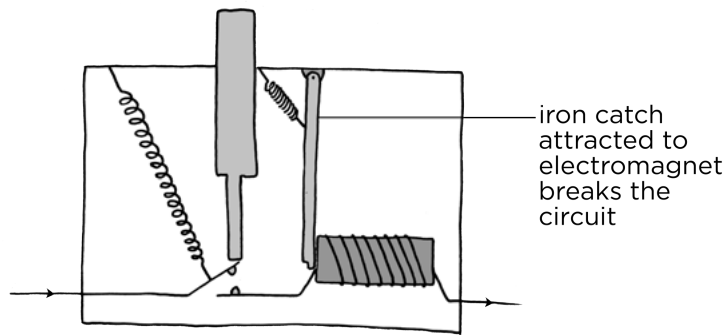

There is a reset button which can be pushed in order to push the contacts back together when the fault has been fixed and it is safe to reconnect the electricity.

Earth leakage

We have mentioned the dangers of electric charge in previous chapters. An electric charge will move from where there is a lot of potential energy to where this is less potential energy. Do you remember learning about lightning? The excess electrons from the clouds move to the ground and transfer a large amount of energy in the process.

The earth leakage circuit breaker is used in the electrical circuits of households and businesses. The circuit breakers for the different parts of the circuit are put into the electrical distribution board. The earth leakage circuit breaker is also on the distribution board.



An example of the earth leakage and main switch on a distribution board in a house.

The earth leakage circuit breaker is a safety device which can switch off the electricity supply to the house. The earth leakage is able to detect if any current is moving through the earth wire. If current is moving through the earth wire then there is a short circuit somewhere, for example as explained with the washing machine. The earth leakage circuit breaker then shuts down all the current as a safety measure.

Lightning is always a danger to an electric circuit. In areas where lightning strikes are common, a lightning spike is often used. This is a metal pole which is connected to the house with one end buried in the ground.



A lightning rod on the roof of a house.

If lightning strikes the house then the surge in current will flow through the metal spike and go safely into the ground. This helps to prevent electric fires in households due to a lightning strike.

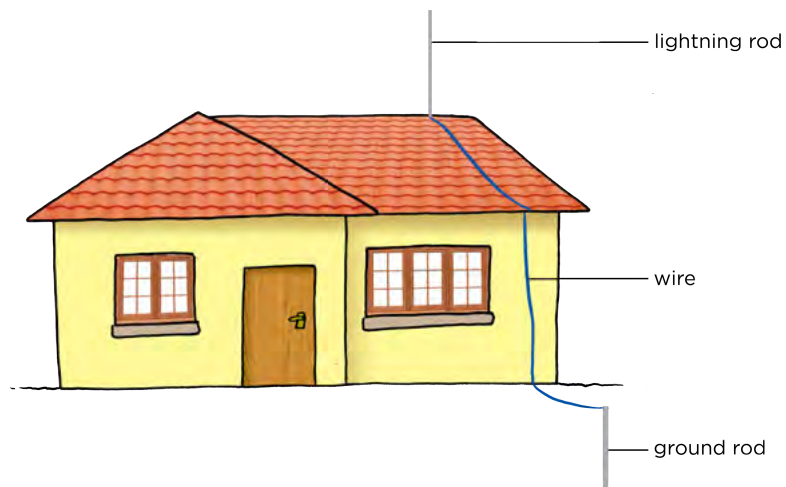

VISIT
Wiring a plug.
bit.ly/1c057ck

Wiring a 3-pin plug

In the first section in this chapter, we learned about the three wires that are attached to most electrical appliances. Complete the following table to identify the colours of these three wires.

TEACHER'S NOTE

Wire	Colour
Neutral wire	Blue
Earth wire	Green-yellow striped
Live wire	Brown



The three wires that form the cable leading to a plug.

Why are there three wires? For a complete circuit we have wires coming into the house and wires leaving the house. The wire which enters our homes is the live wire. The neutral wire leaves our homes and is earthed as it leaves the house. The earth wire has a very low resistance and is connected through the plug socket to the earth cable of the house. The earth cable leads into the ground. If an electrical appliance becomes charged due an electrical fault, it can discharge through earth wire and earth cable and into the ground. This prevents someone from getting an electric shock from a fault in an appliance.

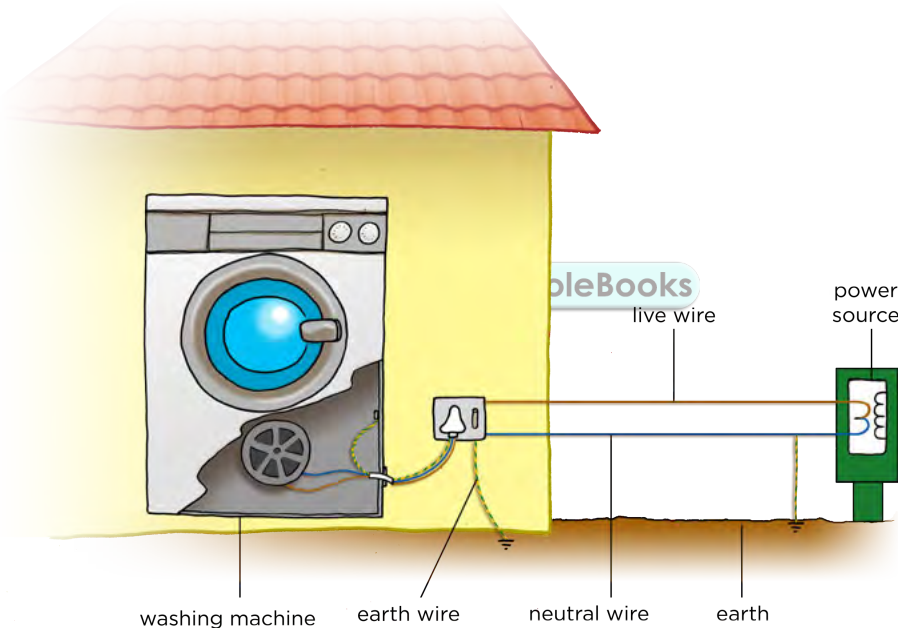

Houses and other buildings are connected to the national grid by the live wire entering the house and the neutral wire leaving the house.

TAKE NOTE

The neutral wire is earthed as it leaves the house, as shown in the diagram, to protect the national grid from lightning strikes. If lightning strikes the overhead cables or transmission lines, then the current flows into the ground rather than burning up the entire network.

VISIT

A short video showing how to wire a 3-pin plug
bit.ly/18JuoUj

The electrical plug has three metal pins. Each pin has a hole in it with a small metal screw. Loosening the screw opens the hole, tightening the screw closes the hole. Let's take a look inside a plug to see how to wire it.



ACTIVITY: Wiring a 3-pin plug

TEACHER'S NOTE

It is important that the learners get to practice this themselves. You do not need a 3-pin plug for each child. Divide the class into small groups and give each group one set of apparatus. Each learner in the group can then have a turn to wire the plug and then undo the plug for the next learner to have a turn.

Stress the importance of stripping the wires carefully. If the copper wires are cut or damaged then it can lead to an unsafe plug being used.

MATERIALS

- piece of insulated electrical cord
- wire strippers or craft knife
- 3-pin plug
- small screwdriver

Have a look at the photo of a 3-pin plug.



A South African plug.

1. Which pin is the green-yellow cable connected to?
The green and yellow earth wire is always connected to the uppermost pin.
2. Which pin is the blue neutral wire attached to?
When viewed from the underneath of the plug, the blue neutral wire is always attached to the pin on the right.
3. Which pin is the brown live wire always attached to?
When viewed from the underneath of the plug, the brown live wire is always connected to the pin on the left.

We are now going to wire our own plugs.

INSTRUCTIONS

1. Cut about 2 cm of the white insulation off the electrical cord to expose the three wires within it. Do not slice directly into the wire as though you are cutting a loaf of bread. Move the blade carefully around the cord in a circle until you have cut through the insulation.

2. Once you have exposed the three different coloured wires, cut away about half a centimeter of insulation from each of these three smaller insulated wires to expose the copper wire inside.
3. Twist the copper wires gently with your fingers so that the strand is tight.
4. Open the plug cover.
5. Unscrew the little screws on the 3 metal pins.
6. Insert the copper wire into the metal pins. The green and yellow wire goes into the top pin (often labelled 'E' for earth, or with the symbol for earthing). The blue wire must go into the pin on the right when viewed from the bottom (often labelled 'N' for neutral). The brown wire must go into the pin on the left when viewed from the underneath of the plug (often labelled 'L' for live).
7. Tighten each of the little screws to trap the wires in place.
8. Replace the plug cover.
9. You have now correctly wired a 3-pin plug and attached it to the electrical cable.
10. When you wire a 3-pin plug of an actual appliance, what safety precautions do you think you need to follow? Discuss this with your partner or class and write down your answer here.

TEACHER'S NOTE

Learners must note that here in the activity they used plugs which are not connected to an electrical appliance. So, when using an actual electrical appliance, they must make sure that the appliance is not turned on or does not have any other connection. They must also work on a dry surface.

TAKE NOTE

When viewed from the underneath with the pins facing towards you, the green and yellow earth wire is always connected to the uppermost pin, the blue neutral wire to the pin on the right and the brown live wire to the pin on the left.

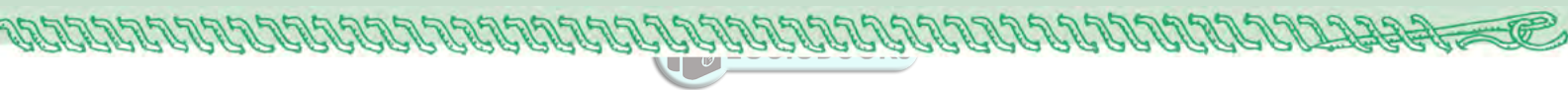

Now that we know more about the safety practices in electrical wiring in buildings, let's practice by designing the wiring for a house.

ACTIVITY: Wiring a house

TEACHER'S NOTE

It is not necessary for the learners to build a model of this circuit. The learners need to plan how they can set up a circuit for the house which would allow each room to have a light which switches on and off without breaking the entire circuit. In other words, they will need to set up a parallel circuit with switches in each branch. The house should have a main switch capable of switching off all of the lights and a fuse, in case of overload.

INSTRUCTIONS:

You have made a doll's house for a neighbour's little girl. The doll's house has 2 bedrooms, a bathroom, a lounge and a kitchen. You want to make a simple electrical circuit for the doll's house.

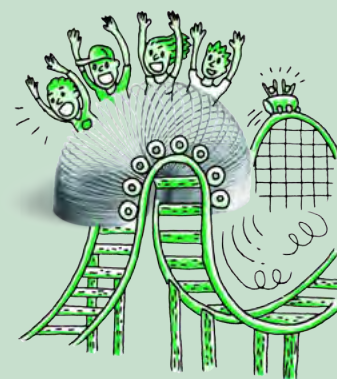

Start off by drawing the floor plan of the house. Once you have this, draw in the wiring system to show how you would put a light bulb in every room. Each light must be able to switch on and off without affecting the other lights in the house. There must be a mains switch located in the kitchen and a fuse to prevent overload.

You should practice this on rough paper before drawing the final design in your workbook. Include the labels for each room.

5.2 Illegal connections

An illegal electricity connection is made when a person attaches their home's electrical circuit to the national grid without a meter. This is done without the consent or knowledge of Eskom. Eskom cannot monitor the electricity consumption and so the electricity is being stolen as these consumers do not pay for the electricity.

Some people make money by supplying illegal connections and others have no legal way to access electricity and so they resort to illegal connections. Others have access to legal electricity, but prefer not to have to pay for it. Not only are these types of electrical connections illegal and considered energy theft, they are also very dangerous, as you will see in the next activity.



Electricity theft is illegal and also very dangerous due to the insecure connections and fire risks.

ACTIVITY: Case study on illegal electricity connections

INSTRUCTIONS:

1. Read the following newspaper article.
2. Answer the questions that follow.

Doornbach informal settlement celebrates electricity provision

WestCapeNews, July 2012

There was much celebration in Doornbach, an informal settlement just outside of Cape Town, when the City switched on about 200 new electrical connections over the period of a few months in 2012. The illegal electricity connections had previously been the only supply of electricity to the area. Authorities often encounter fierce opposition when trying to cut down illegal electricity connections in informal settlements. But, the Doornbach residents immediately took it upon themselves to cut down the massive web of illegal wires in response to finally receiving formal, legal electricity provision.

Besides the mass of wires running through the informal settlement, many of the wires had been strung across Potsdam Road, the main road running through. This was very dangerous as the wires hung very low and would often catch on trucks passing through and snap. Fire threats and electrical shocks to passers-by and vehicles was also a safety concern. The use of legal electricity will also help to prevent shack fires as residents will rely less on candles and paraffin stoves.

A fifty-two-year-old Doornbach resident, celebrating the end of illegal connections in the settlement, said that she had lived there for 18 years and never received any municipal services from the City. The reason being that they had originally settled on privately owned land, which meant that the City could not, in terms of National legislation, install services on privately owned land. However, the City bought the land in May 2011, and Eskom could therefore begin the process of providing electricity to households in Doornbach. The fifty-two-year old was very excited about being able to use an electric iron and installing a refrigerator.

As a symbolic gesture, the residents took it upon themselves to remove the illegal wires. Many of the youth climbed up the dangerous makeshift poles in order to collect the wire which they would then sell to scrap yards. Not everyone was celebrating the switching on legal electricity connections in Doornbach. Many residents in neighbouring settlements, living in formal housing, were making money by selling and supplying electricity illegally to Doornbach. Street lighting has also been installed in Doornbach and it is hoped this will help to reduce the crime rate.

Lastly, the City of Cape Town extended their sincere thanks to the community of Doornbach, as without their support, involvement and cooperation, such a project would not have been possible.

QUESTIONS:

1. What is an informal settlement?

An informal settlement is a settlement that has not been planned by city planners. This means that there are no proper roads or housing developments. There are also no sanitary, water or electrical services in place before people settle on the land.

2. After reading this article, what do you think is the main reason that the people of Doornbach originally set up illegal connections?

The residents settled on privately owned land which did not have electrical connections on site.

VISIT

Why does open education matter? Watch this video.

bit.ly/1fQgh3W

3. Why is it dangerous for youths to climb the makeshift electricity poles?
The wires are not always insulated and touching live electrical wire can cause electrical shock.
4. What were some of the physical dangers of the illegal connections in Doornbach?
The illegal connections can electrocute passers-by, cause fires, and the wires hung very low over the main road which would then catch on trucks passing through.
5. Aside from the physical dangers associated with illegal electrical connections, why else are they illegal?
Eskom is not being paid for the electricity used by the residents. This means that they are losing money because they are indirectly providing the electricity.



SUMMARY:

Key Concepts

- Electricity can be dangerous and so we need safety devices such as fuses, circuit breakers and earth leakages to reduce risk.
- A fuse is a safety device with a very low resistance wire, designed to melt if it experiences a large enough current. This breaks the circuit and protects the appliance, as well as preventing a possible fire hazard.
- A circuit breaker is like a fuse, but acts as a switch which breaks the circuit in response to an electrical fault or overload. It can be reset.
- Many electrical appliances with a metal casing have an earth wire attached to prevent electric shocks if there is a short circuit.
- A three-pin plug has three wires: a brown live wire, a blue neutral wire and a green and yellow striped earth wire.
- The earth wire has a very low resistance and is connected through the plug socket to the earth leakage system of the house, and into the ground.
- A plug must be connected properly in order to make sure that it is safe to use.
- Illegal electricity connections are both dangerous and illegal. It is a crime to steal electricity.

Concept Map

Complete the concept map on the following page to summarize what you know about safety with electricity.



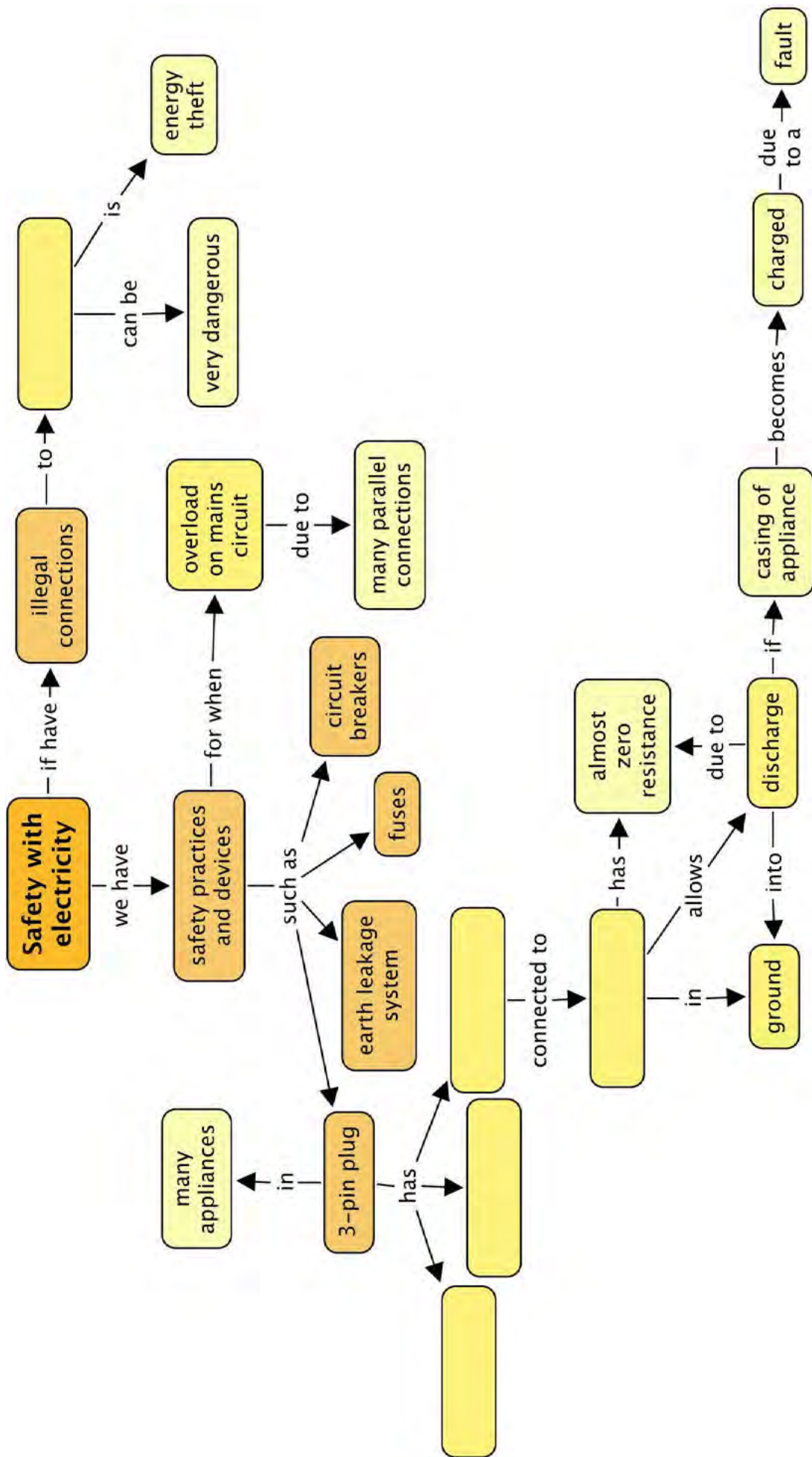

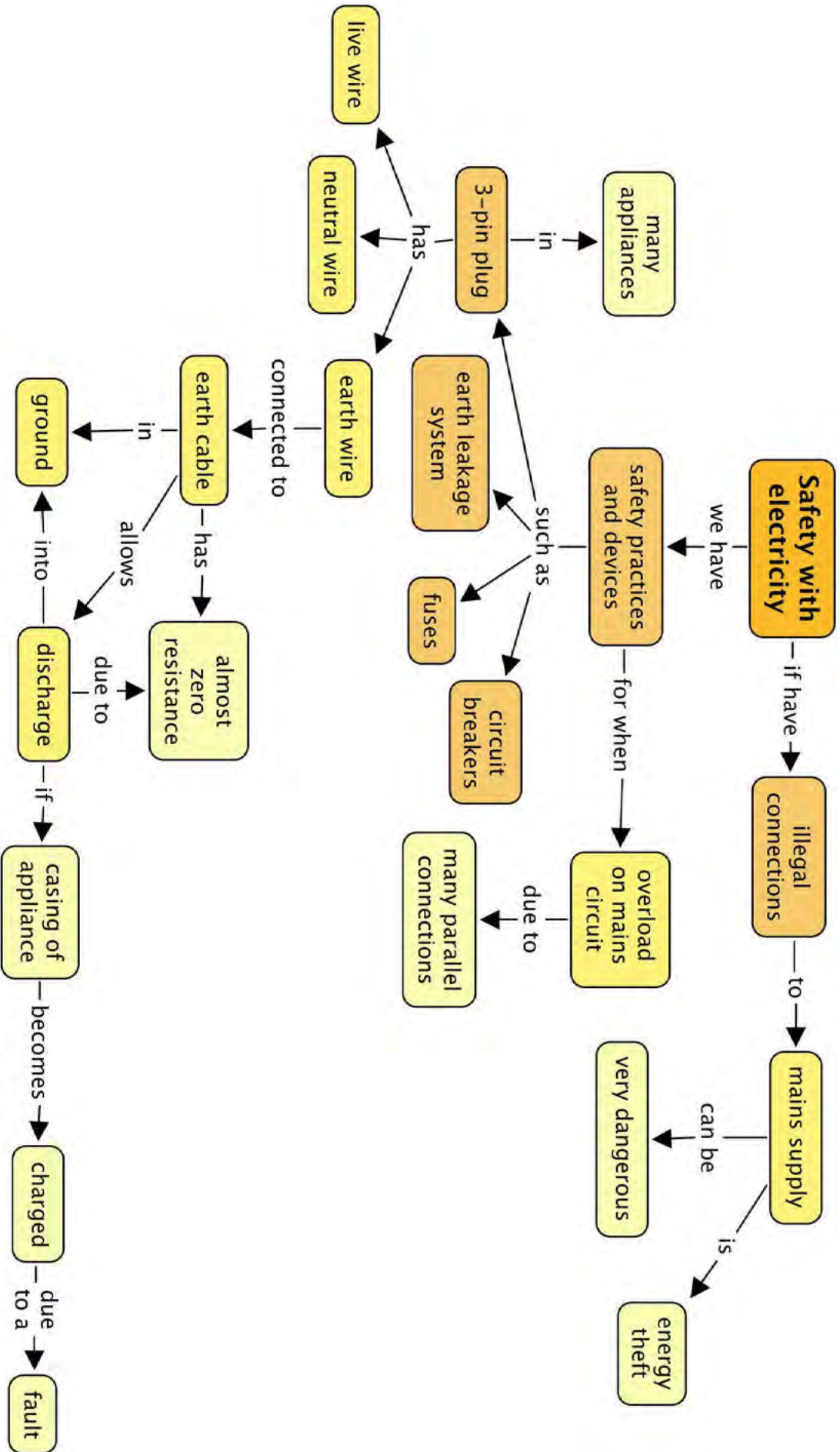

REVISION:

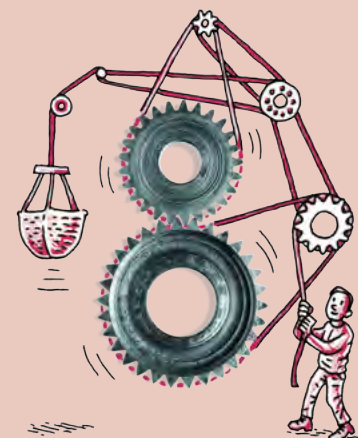

1. Explain how a fuse functions to protect an electric circuit. [4 marks]
A fuse is a low resistance wire which will melt if the current is too strong. The fuse melts and breaks the circuit. This stops the electric current and prevents fires or other safety hazards.
2. What would happen if you used a 3 A fuse in an electrical fan heater that needs a current of 8A to function? [1 mark]
The 3 A fuse would burn out and the fan would not work.
3. What type of fuse should you use in the 8 A fan heater? [1 mark]
The fuse should have a rating higher than 8 A so that it would only burn out if the current was bigger than 8 A.
4. Why are circuit breakers more convenient to use than fuses? [2 marks]
The circuit breaker can be reset but the fuse is destroyed and so needs to be replaced each time.
5. When a fuse "blows", why do you think it is important to fix the problem before replacing the fuse? [2 marks]
If the problem is not fixed then the current will still be too big and the new fuse will also "blow". The circuit might be dangerous to operate. You might risk an electric shock.
6. What is a short circuit? [3 marks]
A short circuit is an alternative pathway with an extremely low resistance. All of the current will move through the short circuit. Because of the low resistance the current increases and can cause an overload on the circuit.
7. Why is a short circuit dangerous? [2 marks]
The current is very strong in the short circuit and there is a danger of electrocution. If someone touches the short circuit or acts as the short circuit then they could get badly hurt or killed.
8. What is the colour of the live wire in an electrical cable? [1 mark]
Brown.
9. Write down one safety precaution that should be followed when wiring a 3-pin plug. [1 mark]
*Make sure that the electrical supply is switched off.
Work on a dry surface.*
10. What is the purpose of the green and yellow wire in an electrical cable? [2 marks]
The green and yellow wire is the earth wire. It ensures that any surge in current due to an electrical fault is safely grounded.
11. Draw an outline of a 3-pin plug and label where each wire is connected and what colour each wire is. [6 marks]
Learners must draw a basic outline of a plug with three circles. The top wire is the green-yellow striped earth wire. The blue neutral wire is always attached to the pin on the right when viewed from the bottom. The brown live wire is always connected to the pin on the left when viewed from the bottom.
12. Draw a circuit diagram for the following circuits:
 - a) A series circuit with 2 cells and three light bulbs. Insert a fuse that will break the circuit and all the bulbs won't work if there is a short circuit. [3 marks]
 - b) A circuit with a cell and two light bulbs in parallel with each other. Insert a fuse into the circuit so that if the fuse breaks, only one of the light bulbs will switch off. [3 marks]

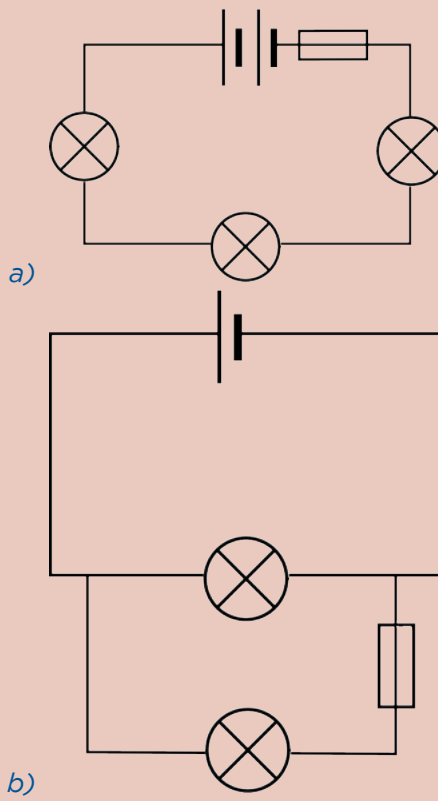

Total [31 marks]





TEACHER'S NOTE**Chapter overview**

1 week

This chapter revises the work covered in Grades 7 and 8, with an emphasis on nuclear fuel. Try to arrange an excursion to a power plant or ask if an engineer is able to come to the school to explain how the power plant operates and to answer questions posed by the learners. This would provide an opportunity for the learners to ask questions about careers in the electrical industry. Here is a link to the Wikipedia article which lists all the power stations in South Africa. bit.ly/15vo5Vk

Here is a table summarising some of the various power stations in South Africa and which province they are located in, for your reference. The only nuclear power station is Koeberg Power Station in Cape Town.

Coal-powered stations

Power station	Province
Arnot Power Station	Mpumalanga
Bloemfontein Power Station	Free State
Camden Power Station	Mpumalanga
Duvha Power Station	Mpumalanga
Kelvin Power Station	Gauteng
Lethabo Power Station	Free State
Matimba Power Station	Limpopo
Pretoria West Power Station	Gauteng

Hydroelectric Power Stations

Power station	Province
Drakensberg Pumped Storage Scheme	Free State
Gariiep Dam	Free State-Eastern Cape border
Ingula Pumped Storage Scheme	Kwa-Zulu Natal
Kouga Dam	Eastern Cape
Palmiet Pumped Storage Scheme	Western Cape
Steenbras Pumped Storage Scheme	Western Cape
Vanderkloof Dam	Northern Cape

6.1 Electricity generation (1 hour)

Tasks	Skills	Recommendation
Activity: Hydroelectric power	Following instructions, observing, identifying, describing, explaining	Suggested
Activity: Alternative energy power stations	Research, summarising, comparing, discussing, writing	CAPS suggested (this can be used as a possible project)

6.2 Nuclear power in South Africa (1.5 hours)

Tasks	Skills	Recommendation
Activity: Advantages and disadvantages of nuclear power	Researching, comparing, discussing, debating, writing, working in groups	Suggested

6.3 National electricity grid (0.5 hours)



KEY QUESTIONS:

- How is electricity generated in a power station?
- What energy sources are used in South Africa to generate electricity?
- Is nuclear energy the best way to solve the energy crisis?
- What are the advantages and disadvantages of nuclear power?
- How is electricity distributed from power stations to our homes?

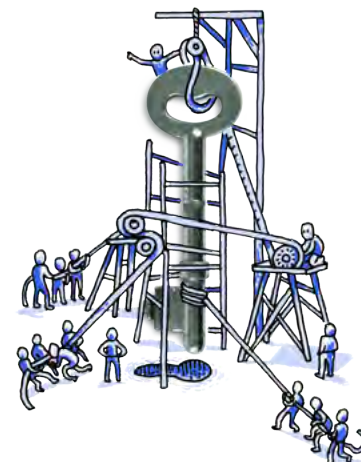

6.1 Electricity generation

VISIT

Electricity generation
(video). bit.ly/GY3JbX

Electricity is generated in a power station. In previous grades, we have looked at how electricity is generated within coal-powered power stations and distributed to the country in the national electricity grid. We are going to revise some of these concepts.



A coal-powered power station.

The general method for producing electricity is to turn a turbine which will turn a generator. In South Africa most of the power stations use coal for fuel. The coal is mined out of the earth. The coal is transported to the power station in large trucks or trains.

Let's take a closer look at what happens inside a coal-powered power station. Have a look at the following diagram.

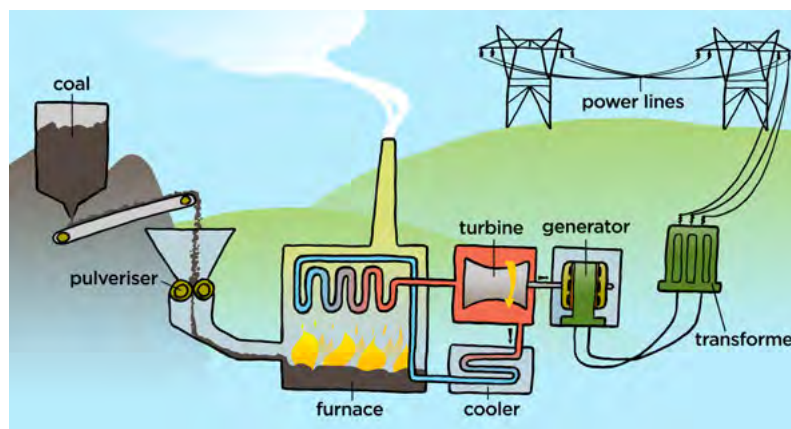

An overview of the steps in a coal-powered station:

1. The large chunks of coal are first crushed into a fine powder. This is called **pulverisation**.
2. The coal is then transported to a **furnace** where it is burnt.
3. The thermal energy from the burning coal is used to boil water and generate **steam**.
4. The steam pushes the blades of the **turbine** and so the turbine spins.
5. The turbine is connected to the shaft of the **generator** which then rotates large magnets within wire coils, which generates electricity.
6. The **electric current** is sent through the **power lines** to businesses and homes.



This is the Orlando Power Station in Soweto, which served Johannesburg for 50 years from 1951. It is not used anymore. The painted cooling towers are seen the most prominently, but the building to the right is also part of the power station.

Is coal a renewable or non-renewable energy source? Explain your answer.

TEACHER'S NOTE

It is non-renewable as there is a finite amount and it cannot be replenished.



What are the disadvantages of South Africa's reliance on coal as the main source of energy in power stations?

TEACHER'S NOTE

Discuss this with your class. This is revision of what learners have covered in previous grades. The main disadvantages are:

- The use of coal is not sustainable as coal is a non-renewable energy source.
- The use of coal has serious negative environmental impacts. Burning coal releases greenhouse gases which build up in the atmosphere. This contributes to the formation of acid rain and the greenhouse effect, leading to global warming.

VISIT

Learn more about the greenhouse effect with this simulation. bit.ly/16gEHQY

TAKE NOTE

In Gr. 8 you might have made miniature turbines and seen how steam is able to make the blades of the turbine turn. You can refer back to this by looking online at www.curious.org.za



A modern day steam turbine connected to a generator.

VISIT

How a coal power station works (video)

bit.ly/1a7rqJB

There are many different ways to get enough energy to turn the turbine. What are some of the alternative energy sources which can be used instead of coal? List them below.

TEACHER'S NOTE

Alternative energy sources include:

- wind
- falling water (hydroelectric)
- sun-heated steam
- nuclear fission
- tidal energy (waves in the sea)
- biofuels

VISIT

How hydroelectricity works.

bit.ly/19YgYE6

The Gariiep Dam on the border of the Free-State and Eastern Cape provinces is a hydroelectric power station which uses the water falling out of the dam to turn the turbine. How does the falling water make the turbine turn? Let's investigate that a little more.

ACTIVITY: Hydroelectric power

MATERIALS:

- aluminium foil plate or cooking tray
- scissors
- pencil
- adhesive tape or packaging tape
- piece of string about 45 cm long
- eraser
- nut, bolt, or other small mass piece
- source of running water, such as a tap



TEACHER'S NOTE

If you cannot get an aluminium foil plate then you could use thick cardboard. The cardboard wheel will not last long when exposed to water so you will have to take that into account. You cannot use the same wheel over again.

INSTRUCTIONS:

1. Cut out the circular bottom of an aluminium foil plate. If it isn't circular then use a compass to draw a circle in the base and cut it out.
2. Make eight equally spaced cuts toward the centre of the foil circle, as shown with the solid lines in the diagram. End each cut about 2 cm from the centre. You now have eight triangular sections.

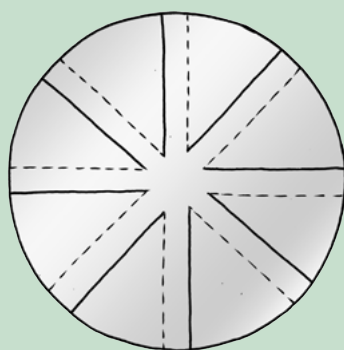

1. Fold each of the sections upwards. Use a ruler to help you get a straight edge. Use the dotted lines in the diagram as a guide.
2. Make a small hole in the centre of the plate. Push a pencil through the hole. The pencil should fit tightly into the hole. Use adhesive tape to stick the wheel to the pencil so that if you rotate the pencil, the wheel rotates.
3. Tie a piece of string around one end of the pencil. Tie the small nut or bolt to the other end of the string.
4. Hold each end of the pencil lightly between your thumbs and index fingers.
5. Hold the wheel under a slow stream of water from a running tap. Make sure to hold the wheel so that the blades are in the water, as shown in the diagram.

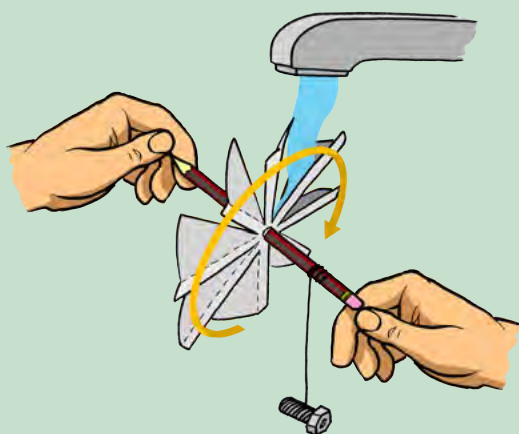

QUESTIONS:

1. What happens to the aluminium wheel when it is placed in the stream of water?
The wheel turns.
2. What happens to the mass piece when the aluminium wheel is in the water stream?
The mass piece is pulled upwards by the turning pencil, as the string wraps around the pencil.
3. Explain the energy transfers between the falling water and the mass piece lifting.
The water has gravitational potential energy which is converted to kinetic energy as it falls from the tap. The kinetic energy is transferred to the blades of the wheel. The kinetic energy of the turning blades is transferred to the pencil. The spinning pencil pulls the string upwards, which pulls the mass piece. The kinetic energy of the pencil is transferred to the gravitational potential energy of the mass piece as it moves upwards.
4. The following diagram shows an example of a hydroelectric power station. Answer the questions that follow.

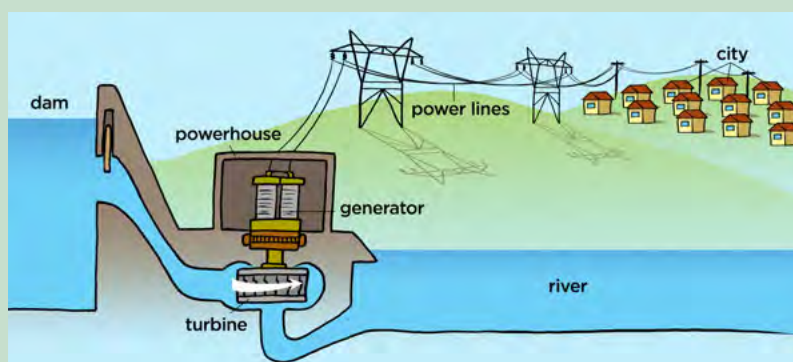

- a) The water in the dam on the left is high up. It has the ability to fall down. What kind of energy does the water have?
- b) As the water flows down the outlet from the dam, describe the transfer of energy.
- c) The flowing water then turns the turbine. This is a mechanical system. What energy does the turbine have?
- d) The generator then transfers the energy between two systems. The kinetic energy in the mechanical system is transferred to electrical energy in the electrical system as it generates electricity. What parts make up the electrical system in the diagram?
- e) What is the output from this whole system? In other words, what does the city get?

NOTE: *The following questions can be used as a revision task the next day in class or as a homework task.*

The water has gravitational potential energy.

- a) *The gravitational potential energy is transferred to kinetic energy as the water moves/flows down.*
- b) *It has kinetic energy.*
- c) *The electrical system is made up of the generator, the power lines and then the houses/buildings in the city.*
- d) *The city gets electricity to run appliances, machines, equipment, lights and heating systems.*

A large dam wall is often built to collect the water. The water then flows

through the hydroelectric power plant.

VISIT

The largest dam in the world. bit.ly/1fQukXr



A large dam wall with a hydroelectric power plant.



The generators inside the hydroelectric power plant.



The water then flows out the bottom of the power station and continues down the river.

VISIT

Generate electricity with a bar magnet with this simulation. Discover the physics behind the phenomena by exploring magnets and how you can use them to make a bulb light. bit.ly/1gRKMpj

VISIT

How to make your own simple generator. bit.ly/1i2Itn

A turbine can be used to transfer kinetic energy from the falling water to the generator. A generator is a device which converts mechanical energy to electrical energy. A generator consists of large metal coils which move within a magnetic field. In some generators the coils are stationary and the magnet is rotated and in other generators the magnets are stationary and the coil is rotated. Turning a set of conducting metal coils inside a magnetic field generates an electric current.

The modern-day generator works on the principle of electromagnetic induction discovered by Michael Faraday in 1831-32. Faraday discovered that you could cause an electric current to flow by moving an electrical conductor, such as a wire that contains electric charges, in a magnetic field. The movement creates a

potential difference between the two ends of the wire or electrical conductor. This then causes the electric charges to flow through the conductor as current.

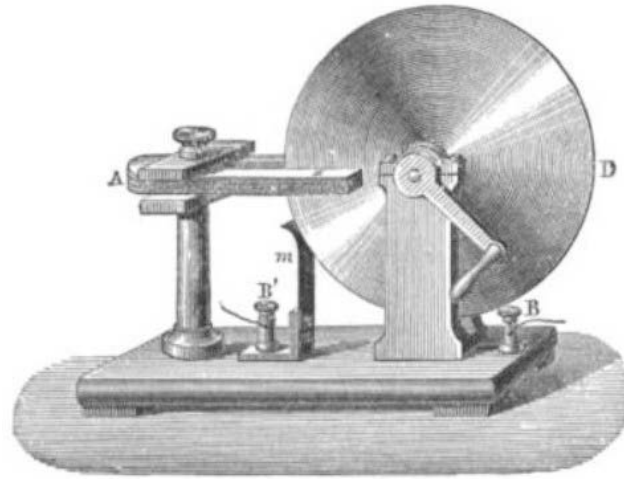

A drawing of the Faraday Disk, the first electromagnetic generator. It consisted of a copper disk rotated between the poles of a horseshoe shaped magnet to generate electricity.



A portable generator used in a home.

There are many different types of generators used in different situations, not only in power stations. Some yachts and boats use water or wind-powered generators to charge their batteries through the use of small propellers in the water or a wind turbine. Portable generators are often used in homes and businesses when there are power outages to keep certain appliances running, such as the lights and refrigerator. Portable generators run on fuel, such as petrol, diesel or gasoline to turn the shaft to generate electricity.

Small generators, called dynamos, can be rotated by a person rotating a crank and are used in devices such as portable radios and torches, especially on mining helmets. Dynamos are also used in bicycle lights. The dynamo in a bicycle consists of a permanent magnet and some surrounding coils of wire, and is attached to the wheel, which rotates as the bicycle moves. As the dynamo rotates it generates a changing magnetic field that generates electricity in the surrounding coils of wire.



A dynamo on the wheel of a bicycle.

TAKE NOTE

Portable generators produce exhaust fumes which contain poisonous gases that can kill if in high enough levels. When using a portable generator, make sure it is in a well-ventilated area, and away from water as much as possible.

As we have seen, most of the electricity generated in South Africa uses the burning of coal to provide steam to turn the turbines. Some of the electricity is generated using alternative energy sources. Why are they called alternative energies? This is because they are not the main source of energy. Most alternative energy sources are renewable forms of energy.



Wind turbines out at sea are an alternative energy source.

VISIT

A list of the different power stations in South Africa.
bit.ly/16gF4eg

ACTIVITY: Alternative energy power stations

TEACHER'S NOTE

This can be used as a possible research project where learners research one of the alternative power stations in South Africa and present a poster on their findings. They must find out information about the sustainability and environmental impact of the alternative energy power station and compare this to a coal-powered power station.

INSTRUCTIONS:

1. Research the different types of power stations in South Africa.
2. Choose one of the alternative energy sources used in South Africa.



3. Alternatively, your teacher may ask you to do this as a research project and present a poster.
4. Write a paragraph here where you discuss the alternative energy source power station you have researched. In your paragraph, include the following information:
 - a) Compare the alternative energy power station to a coal-powered station in terms of sustainability and environmental impact.
 - b) Discuss the advantages and disadvantages of using the alternative energy source rather than coal for generating electricity.
 - c) Include your references.

TEACHER'S NOTE

Learner-dependent answer.

6.2 Nuclear power in South Africa

South Africa only has one commercial nuclear power station, the Koeberg Power Station in Cape Town. We are going to take a closer look at nuclear power.

VISIT

Eskom's article on the Koeberg power station.
bit.ly/19Yhmm6



The Koeberg Nuclear Power Station outside Cape Town.

Before we look at nuclear fission, let's revise the model of an atom which we have already learnt about. Label the following diagram of the model of an atom.

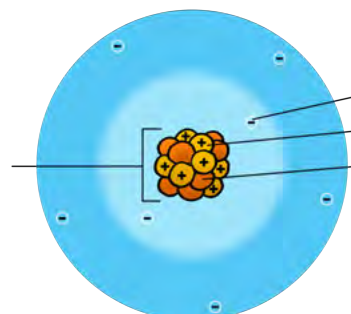

TEACHER'S NOTE

The labelled atom should look as follows:

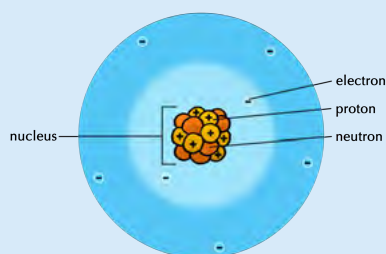

Most atomic nuclei are stable. But, there are some elements which are not stable. The nuclei in these unstable elements spontaneously emit particles, which is referred to as radiation. A nucleus that emits radiation is said to be **radioactive**. Radioactive decay is the process when an unstable nucleus of an atom emits particles. It then 'decays' into another type of atom with a different mass.

Nuclear power was first pursued for electricity generation in the beginning of the 20th century when researchers discovered that radioactive materials, such as radium and uranium, release large amounts of energy when they decay. For a long time, however, the use of nuclear power was not seen as practical or possible to generate electricity.

This changed in the 1930's with the discovery of **nuclear fission**. During nuclear fission, scientists split the nucleus of an atom into two smaller atoms. This releases a huge amount of energy. There is also another way in which the energy in an atom can be released during nuclear fusion. **Nuclear fusion** is when two atoms are brought together to make a new, bigger atom. During both of these nuclear reactions, huge amounts of heat and radiation are released.

TAKE NOTE

You might have first learnt about nuclear fusion in Gr. 8 Planet Earth and Beyond, when looking at where the energy in our Sun comes from.

VISIT

Learn more about radioactive decay by playing with this simulation.
bit.ly/19QuXtL

VISIT

How nuclear power works.
bit.ly/16I2eLo

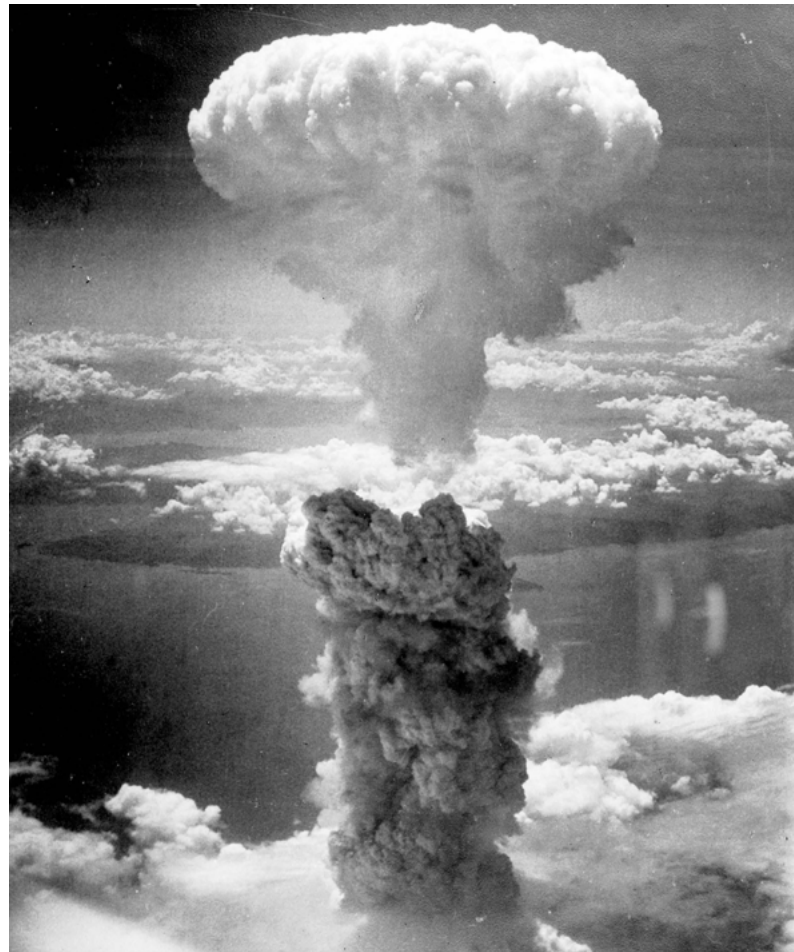

Atomic bombing of Nagasaki on August 9, 1945.

Nuclear power uses nuclear fission, nuclear fusion and nuclear (radioactive) decay. Uranium is an element which is unstable and undergoes radioactive decay at a very slow rate. This makes uranium a good choice to use as a fuel in nuclear power stations. Nuclear power stations therefore use uranium and induce nuclear fission to release the heat and radiation. Let's take a look inside a nuclear power plant, such as Koeberg Power Station.

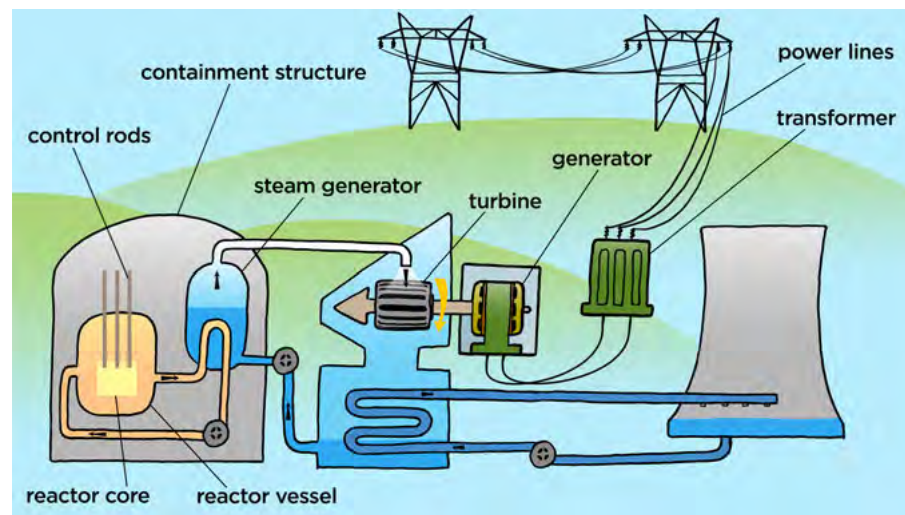

VISIT

Read more about how nuclear bombs work.

bit.ly/1aWleSR

The main difference between a nuclear power station and other power stations, such as coal power stations, is the way in which the water is heated to produce the steam.

A nuclear power station has a nuclear reactor vessel. The nuclear power station needs to control the huge amount of energy given off during nuclear fission of uranium in order to generate electrical energy. The nuclear reactor is the device in which the nuclear reactions take place and are controlled. The uranium is formed into pellets which are arranged into long rods, called the reactor core. The rods together make a bundle which is inserted into water to prevent overheating and melting. The bundle of uranium rods also contains control rods which help to control the process.

The large amounts of energy produced by the nuclear fission reactions in the uranium fuel rods heat the water to produce steam. The steam is used to turn large turbines which transfer the kinetic energy to generators, which produce electricity in the same way as in other power stations.

Most of South Africa's power stations use the burning of coal to produce enough heat to boil the water. The only difference in a nuclear power station is how the energy is produced to heat the water and produce steam.

As was mentioned before, the nuclear fuel is radioactive. The radiation that the fuel emits is dangerous and can be very harmful as it can enter our bodies and damage our cells. The workers in nuclear power plants therefore need to take extra precautions. The nuclear reactor is also contained within a special container that acts as a barrier to radiation.

You might have heard some of the debate surrounding the use of nuclear fuel in power stations. There are many supporters but also many critics. Let's look at some of the advantages and disadvantages of using nuclear fuel.

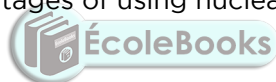

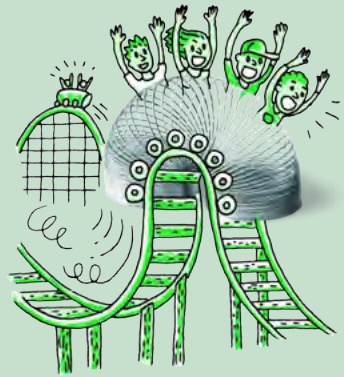

ACTIVITY: Advantages and disadvantages of nuclear power

INSTRUCTIONS:

1. Discuss and answer the questions that follow.
2. You will then be divided into groups to do some extra reading and research and host a debate for and against the advancement and development of nuclear power in South Africa.

What are some of the advantages of nuclear fuel? Discuss this with your partner and write down your answers below.

TEACHER'S NOTE

The biggest advantage is that nuclear power does not depend on fossil fuels. Fossil fuel power stations release huge amounts of carbon dioxide into the atmosphere which contribute to the greenhouse effect and climate change. It is therefore also not affected by the constantly changing oil and gas price. The use of nuclear fuel is also very efficient as huge amounts of electricity are generated using only a small amount of fuel. This is due to the extremely large amounts of energy released during nuclear fission. We are not about to run out of nuclear fuel.

One of the major disadvantages is that once the nuclear fuel has been used, it cannot just be thrown away in a city dump. The spent nuclear fuel is high-level radioactive waste. The radiation can also damage animals and plants. This nuclear waste needs to be disposed of carefully and correctly so that the radiation is not able to cause a lot of damage. Over time, the nuclear waste will decay to safe levels of radioactivity, but this takes thousands of years. In the meantime, it has to be stored so that it does not cause any damage or fall into the hands of nuclear arms manufacturers. This adds to the cost of using nuclear fuels. Some people also have reservations about nuclear power plants as the potential for a nuclear reactor meltdown are catastrophic.

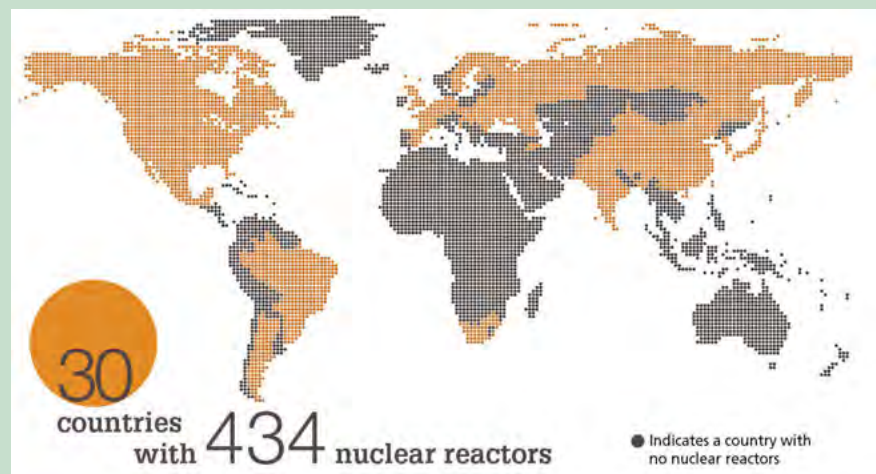

Operating nuclear power stations worldwide.

Research and Debate:

TEACHER'S NOTE

The debate over whether or not nuclear energy is the answer to a growing international energy crisis is very relevant. This is an opportunity for the learners to do some research into the pros and cons of increasing the world's reliance on nuclear energy. It would be a good idea to encourage the learners to find reputable sources of information. They should look at articles and research written by scientists and those with real expertise and knowledge rather than lay people. Arrange the class into two groups; those for the use of nuclear energy and those against the use of nuclear energy. Allow each group to research evidence to support their stance and then let them debate as a class. There is no correct conclusion to the debate. It would be interesting to see if the research and debate causes some of them to change their stance, whether they are for or against. A suggestion is to watch the TED talk on nuclear energy.

You need to conduct further research into the advantages and disadvantages of nuclear power. Your teacher will put you into a group which is either in favour or not in favour of using nuclear power, and developing it further in South Africa. Debate, with your classmates, whether or not nuclear power is the solution to our developing energy crisis. You need to substantiate your point of view and justify your statements either in support of or against nuclear power.



We are now going to look at what happens to the electricity that is generated in a power station, whether it is coal, nuclear or a hydroelectric power plant.

6.3 National electricity grid



The national power lines transmit electricity across the country from the power stations.

The national energy grid is a network of interacting parts which form one big system to provide electricity to all sectors of the economy. It starts at the power stations where the electricity is generated. The power stations then feed the electric current into large power lines called transmission lines. There is a massive network of transmission lines that extends throughout the entire country. The transmission lines are supported by pylons.

The following diagram illustrates a coal-powered power station connected to the national electricity grid.

TAKE NOTE

In a debate, each person must be given a chance to voice his or her opinion and a chance to respond to other opinions.

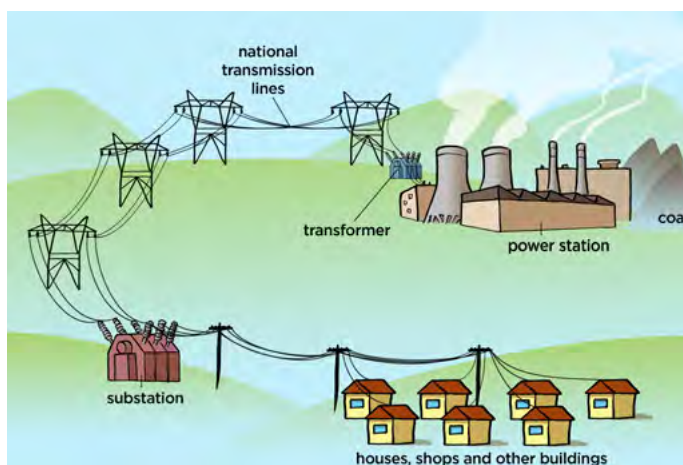

Very high currents are generated at the power stations. The transmission lines have some resistance. If the power stations transferred electricity at high currents, what do you think would happen in the transmission lines? Hint: Remember what we learnt about the effects of resistance.

TEACHER'S NOTE

Transferring electricity at very high currents through wires that have resistance would cause the wires to become hot and so a lot of energy would be wasted in the form of heat to the surroundings.

To prevent the waste of energy, the electric current is rather sent through the transmission lines at very high voltages and low current.

However, these voltages are too high for use in both private homes and commercial buildings. In our homes and buildings we need a low voltage and high current again.

Transformers are used to change the voltages at different points in the grid. As you can see in the previous diagram, the electricity first goes through a transformer before entering the national transmission lines. This is a step-up transformer as it increases the voltage and lowers the current. When the electricity reaches the substation to be distributed locally, there is a step-down transformer which decreases the voltage again and increases the current.

All the systems in the national electricity grid are connected and this means that a power surge or a grid overload can cause blackouts and disruptions throughout the network. What is a power surge?

A power surge is a sudden increase in the voltage somewhere in an electric circuit. The power surge causes an increase in the current strength. This sudden increase in the current strength can damage sensitive circuits.

Lightning strikes near a transmission line can cause a power surge. Other causes of power surges or a grid overload include faulty wiring, or appliances or equipment that require a lot of energy when they are switched on and off. These sudden demands or excesses of energy cause brief changes in voltage that can cause a surge. There are several points in the national grid which can detect a power surge or grid overload. If these are detected then the power supply to that area is cut off.

VISIT

A TED talk on the nuclear energy debate.
bit.ly/1flOpie

VISIT

A documentary on the Fukushima meltdown.
bit.ly/1exijwF

SUMMARY:

Key Concepts

- The national grid is a network of interacting parts. If one part of the system is damaged, it will affect the entire network.
- Electricity in South Africa is mainly produced using coal-fired power stations.
- In a coal station, coal is burned to heat water to produce steam. The steam turns a turbine, which turns a generator to produce electricity.
- There are alternative sources of energy besides coal, to drive turbines, such as wind, hydropower, sun-heated steam, nuclear power and tidal energy.
- Koeberg is the only nuclear power station in South Africa.
- Nuclear power stations use nuclear fuels, such as uranium, to generate heat and radiation by nuclear fission. This heats the water to produce steam to turn the turbine.
- Nuclear fuels are very energy-efficient as a large amount of energy is obtained from a very small mass of nuclear fuel. There is no emission of greenhouse gases in the use of nuclear fuels.
- Nuclear power stations generate radioactive waste materials which need to be properly disposed of. There is much debate around the use of nuclear fuels.
- The national electricity grid is a system to deliver electricity around the country.
- Electricity is carried at high voltages and low current through the national transmission lines to reduce the heating effect of the wires and minimise the energy wasted.
- Transformers are needed to step-up the voltage as the electricity leaves the power station and enters the national grid, and to step-down the voltage for local distributors and consumers.

Concept Map

Complete the concept map on the following page to summarise this chapter on electricity production and delivery.



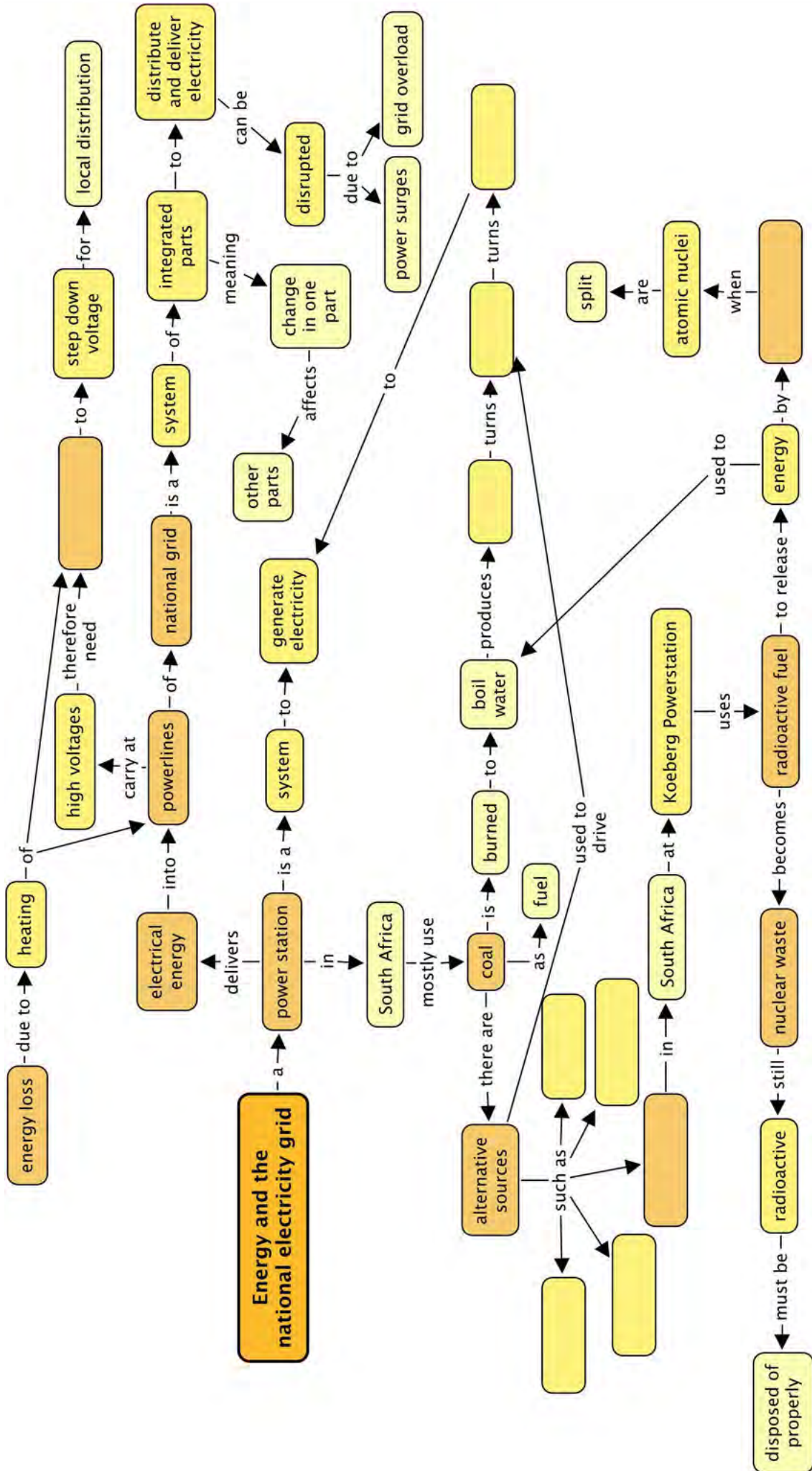

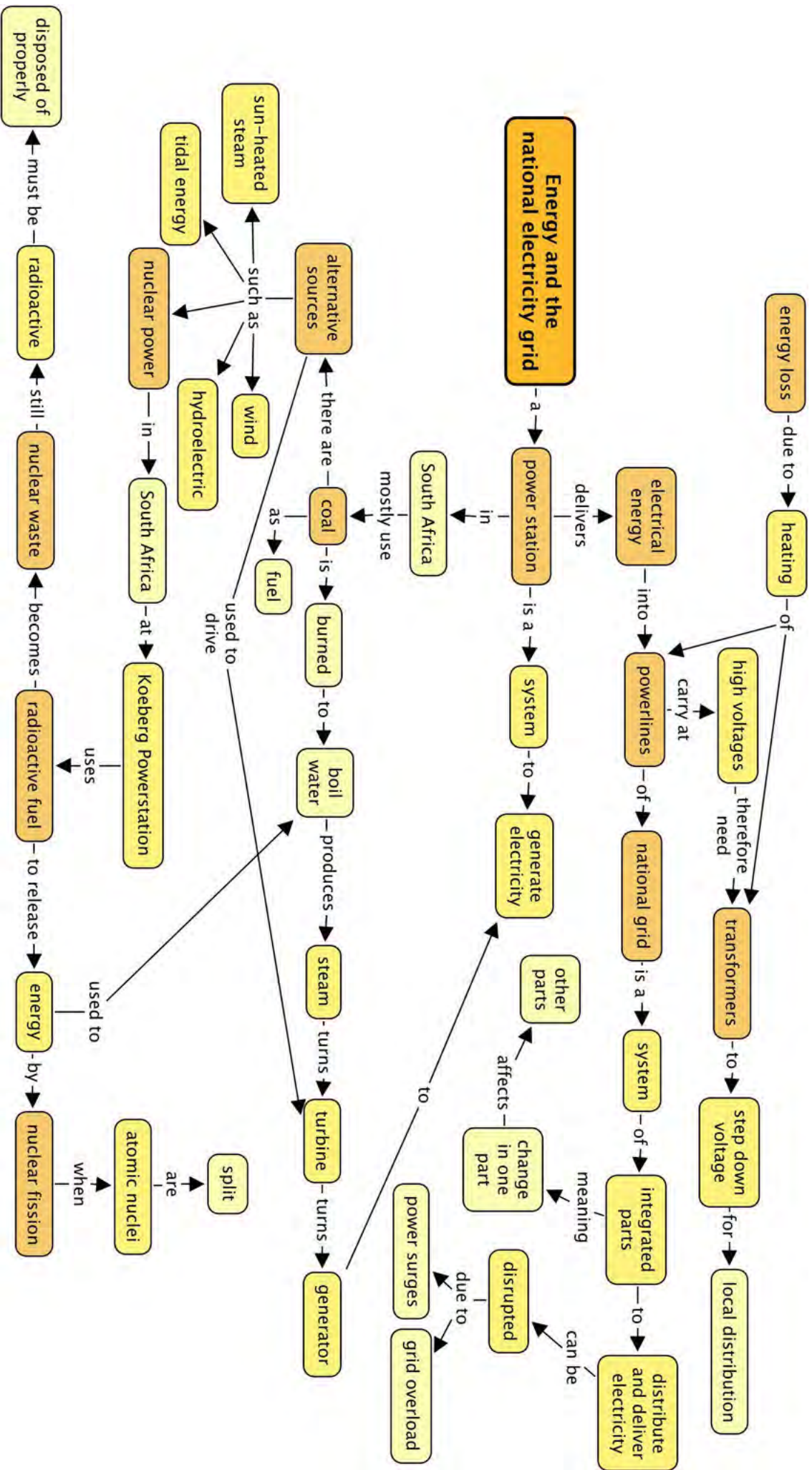

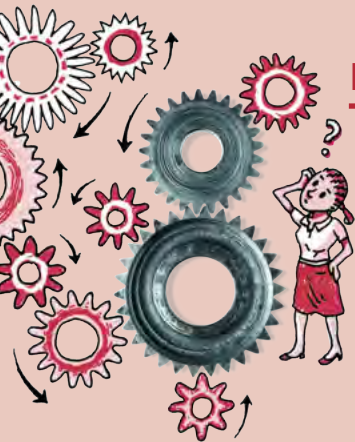

REVISION:

1. Why do you think we can refer to the national electricity supply as a **grid**? [2 marks]
This is because the power lines make up a grid across the country which is a closed circuit. It is a system.
2. What is the main source of energy for power stations in South Africa? [1 mark]
Coal.
3. Why are renewable sources of energy referred to as alternative forms of energy? [2 marks]
This is because the main source of energy is still coal. Any other form of energy is an alternative to the main form of coal.
4. Look at the diagram of a power station. Write a paragraph to describe the process by which electricity is produced in a coal power station. [6 marks]

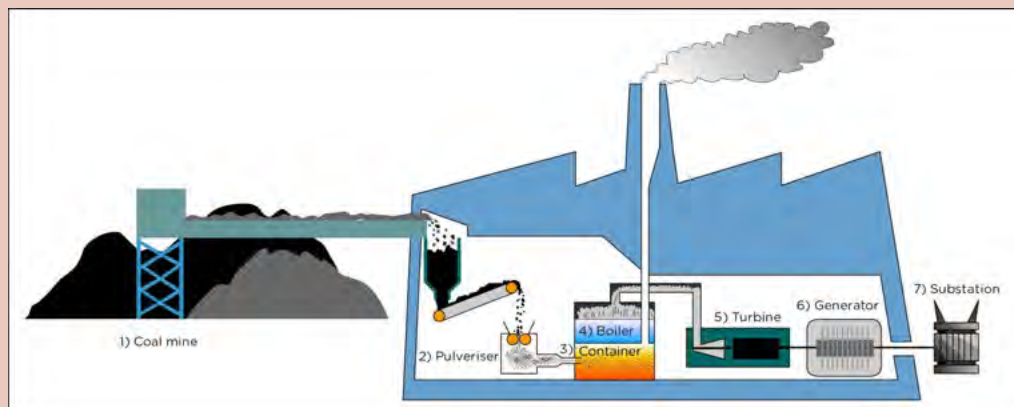

The paragraph must contain the following points:

- the coal is mined and delivered to the coal station
 - the coal is pulverised to make it finer
 - the coal is burned in a furnace
 - the energy is used to boil water
 - the steam turns the turbine
 - the turbine turns a generator which produces electricity
5. Explain the energy transfers which occur in a coal-fired power station. [4 marks]
The coal is burned and releases energy. The energy released by the burning coal is used to heat the water. The water particles have enough energy to change from liquid to vapour. The steam rises and the kinetic energy of the steam particles is transferred to the blades of the turbine. The turbine blades gain kinetic energy and turn.
 6. What is nuclear power? [2 marks]
Nuclear power is the use of nuclear reactions (nuclear fission) to produce useful heat and radiation.
 7. Where is South Africa's nuclear power station? [1 mark]
In Koeberg, just outside Cape Town.

8. What is the difference between nuclear fission and nuclear fusion? [2 marks]

Nuclear fission is when an atomic nucleus is split into two smaller nuclei and nuclear fusion is when two atomic nuclei are joined together to form a bigger one.

9. Write a paragraph to explain the differences and similarities between a coal-fired power station and a nuclear power station. [4 marks]

The paragraph should include the following points:

- *Coal-fired power station burns coal to produce heat needed to boil water to produce the steam that turns the turbine.*
- *Nuclear power stations use nuclear fuel to generate heat by nuclear fission to heat the water to produce steam to push the blades of the turbine.*
- *Both stations turn a turbine which turns a generator.*

10. Write a paragraph to compare how the use of coal impacts on the environment when compared to how the use of nuclear fuels impacts the environment. [4 marks]

Learners should discuss how the mining of coal damages the environment. They must also discuss the fact that the burning of fossil fuels generates an increase in the amount of greenhouse gases in the atmosphere which contributes to climate change. Learners can discuss the fact that nuclear fuels do not generate greenhouse gases. However, the spent nuclear fuel is still radioactive and therefore needs to be stored safely for very long periods of time so that it does not damage the environment or any organisms.

11. Study the following diagram and answer the questions that follow.



The proportion of electricity generated using nuclear fuels in each country in 2013.

- Which country has the highest percentage of its electricity being produced using nuclear fuels? [1 mark]
- What is the percentage of South Africa's energy generated using nuclear fuels? [1 mark]
- Why are all the countries in the world not shown here in this diagram? [1 mark]
- Draw a bar graph to compare the percentage of electricity generated using nuclear fuels to compare South Africa, France, United States of America, United Kingdom, India and China. [6 marks]

- France.
- It is 5%.

- c) *Not all countries have nuclear power stations, so only those with nuclear power are shown here.*
- d) *Learners must draw a bar graph with the bars which do not touch [1 mark]. They must provide a heading [1 mark], labels for each of the axes [2 marks], and plot the correct percentages for each country listed [3 marks].*

12. Why can we consider the national electricity grid as a system? [2 marks]
The national grid is a system as it is made of different parts working together to deliver electricity. A change in one part of the grid will affect other parts.
13. We can divide the national electricity grid up into 4 main stages. These are:
A: Generation (this is where electricity is generated)
B: Transmission (the electricity enters the power lines of the national grids and is transmitted)
C: Distribution (the electricity is distributed from substations to various towns and areas)
D: Consumers (this is where the electricity is transferred to useful energy outputs)
- Use this information to write the letters A, B, C and D on the diagram of the national electricity grid to label these stages. [4 marks]

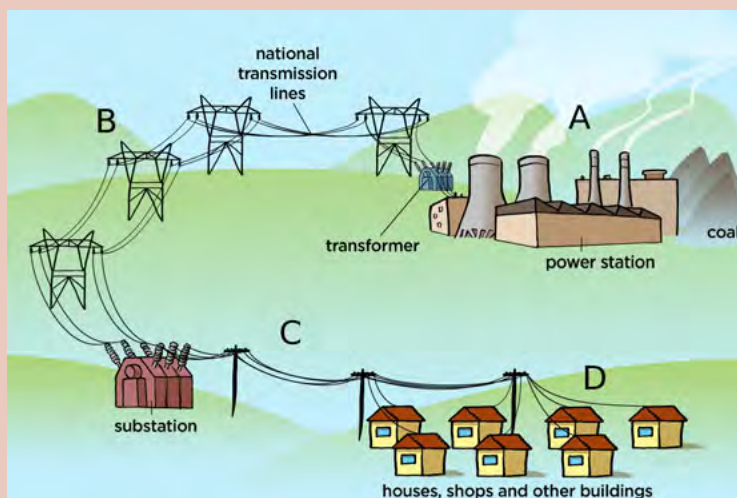

14. Why is electricity transmitted through the power lines at high voltages and low current strength? [3 marks]
There is resistance in the transmission lines. If the current is very high then a lot of energy is lost to the lines in the form of heat. It is expensive to produce electricity and we don't want to waste any. If the current is low then less energy is wasted in the lines.
15. Most household appliances need a voltage of 220 - 240 V. If the electricity in the transmission lines is very high then how are we able to use it? [2 marks]
Transformers are used to change the voltage from high to a low voltage so that the appliances in our homes are not damaged.
16. Why should you protect your computer from power surges? [2 marks]
The sensitive circuits in a computer require small currents. A power surge puts a large current into the circuit. This can damage the wiring in the circuit and stop it from working.

Total [50 marks]





TEACHER'S NOTE**Chapter overview**

2 weeks

This chapter deals with the costs involved when using electricity. Some learners will have prepaid electricity meters in their homes, while others will be billed monthly according to their usage. Which ever way they are billed, they need to have an understanding of how the charges are calculated. In order to simplify the calculations we need to assign a tariff. Eskom uses a sliding tariff scale and so it can sometimes be tricky to calculate exact costs.

IMPORTANT NOTE:

This chapter has rather been called '**Cost of electrical energy**' and not 'Cost of electrical power' as in CAPS. We do not pay for power, we pay for electrical energy.

The following statements in CAPS are **incorrect**:

- consumers pay for the quantity of *power* they use
- quantity of electrical *power* used is measured in kWh (kilowatt hour)

The points should rather read:

- consumers pay for the quantity of *energy* they use
- quantity of electrical *energy* used is measured in kWh (kilowatt hour)

The kilowatt hour is not a measure of power (which is measured in watts). 1 kWh is equal to 3,6 million joules. Joules is the SI unit of energy, but it is a small unit and is therefore not a suitable unit to use on electricity bills. We therefore use the kilowatt hour to measure the energy consumed.

7.1 What is electrical power? (1 hour)

Tasks	Skills	Recommendation
Activity: Power rating of different appliances	Observing, researching, comparing, listing, calculating	CAPS suggested

7.2 The cost of energy consumption (5 hours)

Tasks	Skills	Recommendation
Activity: Calculating energy consumption	Comparing, calculating	CAPS suggested
Activity: Calculating the cost of electrical energy	Comparing, calculating, analysing, justifying, explaining	CAPS suggested
Activity: Home survey	Researching, collecting data, calculating, analysing	Suggested
Activity: Comparing the energy efficiency of different light bulbs	Comparing, describing, calculating, explaining	Suggested
Activity: Career research	Researching, working in groups, writing, presenting	CAPS suggested

KEY QUESTIONS:

- What is electrical power?
- How do we measure electrical power?
- Do different appliances use different amounts of energy?
- How do we know how much power we are using?
- How do we measure our use of electrical energy?
- How can we work out how much our electricity costs?
- How can we reduce our energy consumption?



7.1 What is electrical power?

Electrical power is the rate of electrical energy supply. It is the amount of energy supplied per unit of time. In simpler terms, it is how fast the electrical energy is supplied.

Power is measured in **watts (W)**.

We can calculate the power using the formula:

Power = energy/time

Energy is measured in joules and so this means that power is the amount of joules supplied in a certain period of time. When doing calculations of power, you need to have the energy measured in joules and time measured in seconds.

1 watt is the same as 1 joule of energy transferred in a second. (1 watt = 1 joule per second)

There are 1000 watts in 1 kilowatt (kW).

Different appliances use different amounts of power, depending on their function. All electrical appliances have a stamp or a sticker which indicates the power rating. If you look at your hairdryer or kettle you should find it easily.



The label on an electric pan indicating a power rating of 1400 W.



The label on a fan indicating a power rating of 120 W.

Which of the above two appliances uses more power to operate?

TEACHER'S NOTE

The electric pan uses much more power than the fan.

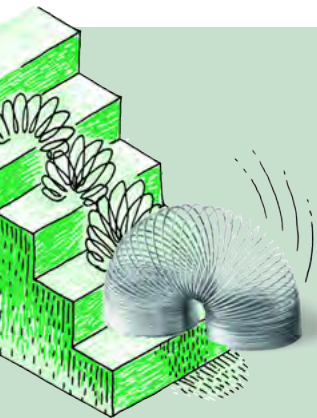

ACTIVITY: Power rating of different appliances

TEACHER'S NOTE

If possible, bring some different appliances to class, such as a kettle, toaster or iron, to show learners the labels with the power ratings on them. You can also walk around the school and identify the different power ratings on appliances around the school. Bring newspapers to school to use the advertisements section to allow learners to also study the appliances and to identify the power ratings. Bring in different light bulbs which have different power ratings to show these to learners.

INSTRUCTIONS:

1. Depending on your class and teacher, you might be able to walk around the school or your classroom and look at different appliances.
2. You might also have advertisements from newspapers or magazines to study.
3. Write down the power rating of each appliance that you find. Complete the table to record your findings.
4. Some photographs of the labels on various appliances have been given below. Include these power ratings in your table.
5. Answer the questions that follow.



The label on the under side of a toaster.



The box for an electric beater.

VISIT
 This video has a few great tips on how you can save electricity, money and the planet! bit.ly/18JylZc



The label on the back of a television.



The label on an urn, for heating water.

TAKE NOTE
 A rate is ratio where one quantity is compared to time, for example km/h which is comparing distance (in kilometers) to time (in hours).

Fill the power ratings of the various appliances into the following table.

Appliance	Power (W)
Toaster	
Electric beater	
Television	
Urn	

TEACHER'S NOTE

Below are the power ratings for the appliances given here. Learners must also identify others.

Appliance	Power (W)
Toaster	700
Electric beater	175
Television	54
Urn	1500

QUESTIONS:

- Complete the following table to convert between joules and kilojoules:

Joules (J)	Kilojoules (kJ)
120	0,12
34 000	34
1 230	1,23
24 600	24,6

- Complete the following table to convert between watts and kilowatts:

Watts (W)	Kilowatts (kW)
1 760	1,76
4 560	4,56
25	0,025
560	0,56

- Sequence the appliances listed in your table above from those that use the most power to those that use the least power.
Learner-dependent answer, depending on the appliances listed. Learners will find that appliances which provide heat use much more energy than appliances, like a fan or radio, which supply movement and sound respectively.
- Did you record the power ratings of any other appliances which involve heating? What do you notice about the power for these appliances?
Appliances involving heating, such as kettles, toasters, irons, heaters, use a lot of power.
- The following questions involve calculations based on the equation:

$$\text{power} = \frac{\text{energy}}{\text{time}}$$

TAKE NOTE
If you are given the amount of energy transferred in kilojoules, you need to convert it to joules to calculate the power in watts.

- a) If 180 kJ of energy is transferred to your bedroom lamp in half an hour, what is the power rating of your lamp? Show your calculations.
- b) 100 000 kJ of energy passes through a power station every minute. What is the power rating of the power station? Show your calculations.
- a) $power = energy/time = 180\ 000 / 1\ 800 = 100\ W$
- b) $power = energy/time = 100\ 000\ 000 / 60 = 1\ 666\ 666,67\ W$

We pay for the electricity that we use in our homes. How do we calculate how much we pay based on our energy consumption?

7.2 The cost of energy consumption

Eskom charges us for the electrical energy we use in our homes. Eskom charges us based on our energy consumption. The more electrical energy we use to run our household **electrical appliances**, the more Eskom charges us.

How do we work out how much energy we use? Think for example of using a 1000 W microwave to warm your food for 1 minute. How much energy is transferred? We can rearrange the following equation:

$$power = \frac{energy}{time}$$

So that we have:

$$energy = power \times time$$

In this formula, energy is measured in joules, time is measured in seconds and power in watts.

Therefore to calculate the energy consumption of using a 1000 W microwave, we can calculate it as follows:

$$\begin{aligned} energy &= power \times time \\ &= 1000\ W \times 60\ s \\ &= 60\ 000\ J \end{aligned}$$

Eskom now wants to work out our energy consumption for the whole month for all the appliances in your home. If 60 000 J of energy were used to warm food for 1 minute, then you can see that we would calculate an extremely large number for our energy consumption for the whole month in joules. This is not practical for electricity bills. We therefore have an alternative unit for energy consumption.

The quantity used for energy consumption is the **kilowatt-hour** (kWh). 1 kWh is the energy used if a 1000 W appliance is used for 1 hour.

We can calculate the energy consumption of different appliances by multiplying the power rating by the amount of time it was used in hours.

TAKE NOTE

The kilowatt-hour is a measure of energy consumption as it is calculated by multiplying power in kilowatts by time in hours.



ACTIVITY: Calculating energy consumption

INSTRUCTIONS:

1. Complete the following table to convert between seconds, minutes and hours.
2. Answer the questions on power consumption showing your calculations.

TEACHER'S NOTE

Seconds (s)	Minutes (min)	Hours (h)
620	10,33	0,172
120	2	0,033
7 620	127	2,12
56 400	940	15,67
16 200	270	4,5
44 100	735	12,25

QUESTIONS:

1. An oven with a power rating of 3600 W is used to bake a cake for 1 hour. What is the energy consumption?
 $3600\text{ W} = 3,6\text{ kW}$
 $\text{energy consumption} = \text{power} \times \text{time} = 3,6 \times 1 = 3,6\text{ kWh}$
2. A kettle with a power rating of 2200 W is used to boil water for 6 minutes. What is the energy consumption?
 $2200\text{ W} = 2,2\text{ kW}$
 $6\text{ minutes} = 0.1\text{ hours}$
 $\text{energy consumption} = 2,2 \times 0.1 = 0,22\text{ kWh}$
3. You use a 3600 W oven to bake a cake for 1,5 hours. What is the energy consumption?
 $3600\text{ W} = 3,6\text{ kW}$
 $\text{energy consumption} = 3,6 \times 1,5 = 5,4\text{ kWh}$
4. A 120 W light bulb is left on for 2 hours. A 60 W light bulb is left on for 3.5 hours. Which light bulb has a higher energy consumption? Show your calculations.
120 W light bulb:
 $120\text{ W} = 0,12\text{ kW}$
 $\text{energy consumption} = 0,12 \times 2 = 0,24\text{ kWh}$
60 W light bulb:
 $60\text{ W} = 0,06\text{ kW}$
 $\text{energy consumption} = 0,06 \times 3,5 = 0,21\text{ kWh}$
 Therefore, the 120 W light bulb uses more power.

TAKE NOTE

A kilowatt-hour requires that the unit of the time is in hours. You must therefore convert any times that you are given into hours for your calculations.

We are charged for the number of kilowatt-hours that we use. The cost of energy consumption is charged in cents per kilowatt-hour (c/kWh). The following table gives us the rates at which homeowners are charged for purchasing their power directly from Eskom. As you can see, there are different 'blocks'. The more energy you use per month, the more you pay per kilowatt-hour. This is called a **tiered tariff** system.

Eskom Homepower Tariffs 2013

Different energy consumptions per month	Energy charge (c/kWh)	Environmental levy charge (c/kWh)	Total (c/kWh)
Block 1 [≤ 50 kWh]	67.07	2.28	69.35
Block 2 [51 - 350 kWh]	83.32	2.28	85.60
Block 3 [351 - 600 kWh]	124.74	2.28	127.02
Block 4 [> 600 kWh]	137.03	2.28	139.31

In order to calculate your electricity costs, choose the block that applies to your home. For example, if your home uses 252 kWh of electricity in a month then you fall into Block 2.

Let's calculate the cost if your home used 252 kWh in April 2013. The first 50 kWh are charged at the lower rate so:
 $50 \times 69,35 = 3\,467,5$ cents

The rest of the units are charged at the block 2 rate:
 $(252 - 50) = 202$

Therefore, $202 \times 85,60 = 17\,291,2$ cents
 So, in total you would have to pay $3\,467,5 + 17\,291,2 = 20\,758,7$ cents

Remember, the tariffs are quoted in cents, not rands, so you need to do a conversion.
 $20\,758,7/100 = R207,59$

This means that your total bill would be R207,59 for the month of April 2013

What if you do not want to work out your entire bill, just how much one particular appliance is costing you? The average per unit price of electricity in 2013 is 71,65 c/kWh. This is the per unit price we will use for our calculations.

TEACHER'S NOTE

The unit price of electricity varies with consumption. The price indicated here was as it was in 2013 for a particular usage. You can also use other rates in your calculations with your class and specify them upfront.

If we want to know how much we will pay for using a particular appliance we would use the following calculation:

VISIT

This table is adapted from bit.ly/GUaTxS

TAKE NOTE

The tiered tariff system is used to encourage people to save electricity and use it wisely as the less you use, the less you pay per unit of electricity.

TAKE NOTE

Remember that we can find the power rating for an appliance on the labels. Did you notice that both of the labels indicated power in watts (W) and not kilowatts (kW)? That means that if you use them to calculate the cost of electricity you must first convert them to kilowatts.

cost = power rating of appliance x number of hours it was used for x unit price of electricity

Let's try an example calculation for the microwave.

We want to work out the cost of using a small oven (1500 W) for a total of 1 hour in a day. The following steps outline what you should do.

Step 1: Write down the formula

cost = power rating x time x price

Step 2: List all the given values in a problem

power rating = 1500 W = 1,5 kW

time = 1 hour

price = 71,65 c/kWh

Step 3: Substitute the given values into the formula to find the unknown

cost = 1,5 kW x 1 hour x 71,65 c/kWh

= 107,475 cents

= R1,07

Step 4: Write down the solution on its own line with the units.

The cost is R1,07 to run a small oven for 1 hour.

Let's try another example.

Have you ever notice your fridge start humming after a period of silence? Fridges are extremely energy-expensive electrical appliances. To keep the temperature at a constant cool temperature, fridges contain a thermostat that measure how cool the air is inside your fridge. When the temperature inside the fridge warms beyond a certain point the thermostat will switch on the energy-expensive compressor and condenser. Fridges are specially insulated so try keep cool air inside, and the energy demands of a fridge varies greatly depending on how often the doors are opened, and what is kept inside.

Imagine now, that you left the fridge door open by accident as you rushed to school and didn't notice until the next day! We now want to work out how much it costs to run a fridge with a power rating of 2200 W for a day.

cost = power rating x time x price

power rating = 2200 W = 2,2 kW

time = 24 hours

price = 71,65 c/kWh

cost = 2,2 kW x 24 hours x 71,65 c/kWh

= 3 783,12 cents

= R37,83 per day

The cost is R37,83 to run a fridge for 1 day.

ACTIVITY: Calculating the cost of energy consumption



INSTRUCTIONS:

1. Use the information in the following table to answer the questions that follow.
2. Use a cost per unit of electricity of 71,65 cents/kWh in all your calculations.

Appliance	Power rating
Microwave oven	1 360 W
Conventional oven	6 000 W
Television	105 W
Geyser	4 800 W
Incandescent light bulb	100 W
Fluorescent light tube	40 W
Vacuum cleaner	1600 W
Washing machine	2200 W

QUESTIONS:

1. Imagine that your family has used 320 kWh of electricity this month. Calculate the cost of the 320 kWh.
 $cost = 320 kWh \times 71,65$
 $= 22928 cents$
 $= R229,28$
2. A potato takes about 1 hour to cook in a conventional oven. In a microwave it takes approximately 12 minutes. Calculate the cost of cooking the potato in each appliance and write down which one is the cheaper option.
 $12 minutes = 0,2 hours$
 $1\ 360\ W = 1,36\ kW$
 $6\ 000\ W = 6\ kW$
 $microwave\ oven: cost = 1,36 \times 0,2 \times 71,65 = 19,49 cents = R0,19$
 $conventional\ oven: cost = 6 \times 1 \times 71,65 = 429,9 cents = R4,30$
The microwave is cheaper to run than a conventional oven.

3. Which light bulb is cheaper to run for an hour, the incandescent light bulb or the fluorescent light bulb? Justify your answer with a calculation.
 $100\text{ W} = 0,1\text{ kW}$
 $40\text{ W} = 0,04\text{ kW}$
incandescent light bulb = $0,1 \times 1 \times 71,65 = 7,165\text{ cents} = R0,07$
fluorescent light bulb = $0,04 \times 1 \times 71,65 = 2,866\text{ cents} = R0,03$
The fluorescent light bulb is cheaper.
4. If you have a prepaid electricity voucher for R15, how long could you watch TV?
 $R15 = 1\,500\text{ cents}$
 $105\text{ W} = 0,105\text{ kW}$
Number of kWh = $1500/71,65 = 20,94\text{ kWh}$
number of hours = $20,94/0,105 = 199,43\text{ hours}$
5. You need to vacuum your room and it takes you 30 minutes to do this. What does this cost?
 $1600\text{ W} = 1,6\text{ kW}$
 $30\text{ minutes} = 0.5\text{ hours}$
cost = $1,6 \times 0.5 \times 71,65$
 = $57,32\text{ cents}$
 = $R0,57$
6. It takes the geyser to two and a half hours to heat water from 20 °C to 65 °C. How much does it cost to heat the water?
 $4800\text{ W} = 4,8\text{ kW}$
cost = $4,8 \times 2,5 \times 71,65$
 = $537,375\text{ cents}$
 = $R5,37$
7. What alternative appliance could a family use to heat water which would not demand such a high use of electricity?
A family can install a solar water heater to use to heat water instead of a geyser. This uses solar power and therefore reduces the family's energy consumption, saving electricity and money.

We can see that different appliances have different power ratings and so require more electricity to run. This means that some appliances are more expensive to run than others. An incandescent light bulb, for example, is more expensive to use than a fluorescent light bulb. If you remember, an incandescent light bulb loses most of its energy as heat, instead of light.

Do you know how much electricity your family consumes? Let's find out.

ACTIVITY: Home survey

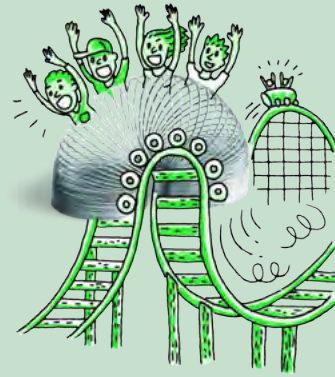

INSTRUCTIONS:

1. List, in a table similar to the one above, all the electrical appliances in your home. The 4 column headings should read: Appliance, power rating, number of hours and cost.
2. Estimate the number of hours for which each appliance is used on a typical day.
3. Calculate the daily cost of each appliance, using 71,65 c/kWh as the unit price. Remember to count the number of light bulbs you have in your home and multiply that by the cost for 1 light bulb.

Use the following space for your table.

TEACHER'S NOTE

The length of the table will depend on the number of appliances in each learner's home. Learners answers will vary. They should perform a separate calculation for each appliance in their home and then add the amounts together to get the total cost of electricity.

Here is an example of what a calculation might look like for a light bulb of 120 W which runs for 2 hours per day. You should encourage learners to follow these steps:

Step 1: Write down the formula

cost = power rating x time x price

Step 2: List all the given values in a problem

power rating = 120 W = 0,12 kW

time = 2 hours

price = 71,65 c/kWh

Step 3: Substitute the given values into the formula to find the unknown

cost = 0,12 x 2 x 71,65

= 17,196 cents

Step 4: Write down the solution on its own line with the units.

Cost of electricity is 17 cents (R0,17)

QUESTIONS:

VISIT
Some more tips on
conserving electricity
bit.ly/1gEctUP

TEACHER'S NOTE

All of these answers will depend of the electrical appliances used in the learner's home. It is important to check that they are using the formula correctly and that they are converting watts to kilowatts and cents into rands.

1. What was your total estimated electricity cost for one day?
Learner-dependent answer.
2. If there are 30 days in an average month, what would your estimated monthly bill be?
Learner-dependent answer.
3. Can you think of any ways that your family could reduce the amount of electricity you use?
This answer is learner-dependant. Some learners might only have a few electrical appliances and would not be in a position to reduce usage. Some learners may indicate that they could be more efficient in their use of electricity. They could switch off unnecessary lighting. Use blankets and other forms of insulation rather than using electrical heaters in winter etc. You may find that some learners are already using geyser blankets and solar panels. Those learners may indicate that they are already doing what they can to reduce electricity use.

There are many different ways in which we can try to conserve electricity in order to save money. Our choice of light bulbs can affect our electricity bills. LED light bulbs are the most energy efficient. They have lower power ratings than normal light bulbs but most of their energy is transferred as light and very little as heat (unlike incandescent light bulbs). Light transmitted from the bulb is measured in lumens.

ACTIVITY: Comparing the energy efficiency of different light bulbs

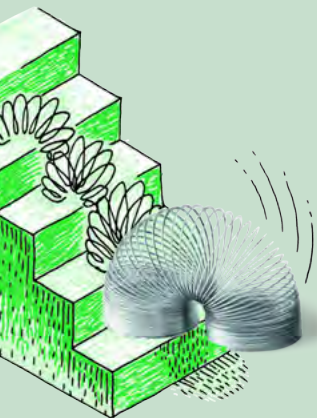



TEACHER'S NOTE

More information comparing these three types of lights is available here:
bit.ly/17ytE0y

INSTRUCTIONS:

Read the information in the table and use it to answer the questions.

	LED	Compact Fluorescent Light bulbs (CFLs)	Incandescent light bulbs
Example			
Average life span (in hours)	50 000	8 000	1 200
Watts	8	15	60
Lumens	800	800	800

1. Which of the three light bulbs will last the longest?

LED

2. Which of the three light bulbs has the highest power rating?

incandescent

3. How do the three light bulbs compare in terms of how much light they can provide?

These three light bulbs all emit the same number of lumens, so they can all provide the same amount of light.

4. Calculate how much it would cost to run each light bulb in a house for 5 hours a day for an entire year (365 days). Use 71,65 cents/kWh.

LED: cost = 0,008 x 5 x 365 x 71,65 = 1046,09 cents = R10,46

Fluorescent: cost = 0,015 x 5 x 365 x 71,65 = 1962,42 cents = R19,61

Incandescent: cost = 0,065 x 5 x 365 x 71,65 = 784,68 cents = R78,46

5. Which light bulb would you choose to use? Explain your choice.

The answer is learner-dependant. Learners should recognise that the LEDs are cheaper to run from day-to-day, although their initial cost is relatively expensive.

6. Which bulb is the best for the environment? Explain your choice.

The LED light uses less electricity for the same light output. This means that less electricity is consumed. If everyone is using LED lights then the overall demand for electricity would be lower and so if less electricity is produced there would be less pollution.



**TEACHER'S NOTE**

This is an opportunity for the learners to be made aware of the many different career paths available in the electrical energy sector. There is a short list of suggested careers to research, but encourage the learners to find more. Have the learners work in small groups to do their research and then have them report their findings back to the class.

INSTRUCTIONS:

1. Divide into groups of 3.
2. Use the library or the internet to research a career from the following list:
 - a) electrician
 - b) electrical engineer
 - c) IT specialist
3. Try to find information about what someone in that career spends their day doing and what qualifications are needed to do the job.
4. Report your findings to the class.

VISIT

Want to take part in some real science research? Check out these citizen science projects to get involved easily. bit.ly/1aFwEJv

QUESTIONS:

1. Write down the career path that you found the most interesting.
Learner-dependent answer.
2. What did you like about that particular career path?
Learner-dependent answer.

**TEACHER'S NOTE**

The Zooniverse website provides a great overview of the various citizen science projects that learners can get involved in. There is a huge variety of projects, from helping to identify possible planets around stars, analysing real life cancer data, looking at tropical cyclone data, or listening to the calls from whales or bats. And there are also many others. Citizen science is scientific research which is conducted in whole or in part by nonprofessional scientists, specifically the general public. Encouraging learners to get involved in some of these projects will open their eyes to the possibilities out there, and also add meaning and value to what they learn within the Natural Sciences classroom. bit.ly/14JxLsw

Did you know that these workbooks were created at **Siyavula** with the input from many contributors and volunteers? Just turn to the front of your workbook to see the long list! Read more about Siyavula at our website: <http://www.siyavula.com> and like our Facebook page.

Siyavula has also created a **range of textbooks** for other grades and subjects, and we are going to be producing more. These textbooks and workbooks are **openly-licensed and freely available** for you to use and download.

Look out for Siyavula's **Everything Science** and **Everything Maths** textbooks next year in Gr 10. These textbooks are available for free at www.everythingscience.co.za and www.everythingmaths.co.za and also on your mobile phone and on Mxit!



SUMMARY:

Key Concepts

- Electrical power is the rate of energy supply, measured in watts (W).
- 1 watt of power is equal to 1 joule per second.
- Different appliances use different amounts of power.
- Electrical energy is sold in units called kilowatt-hours (kWh), a measure of the energy consumption.
- 1 kWh is the energy used by a 1000 W appliance in 1 hour.
- Eskom sells electricity using tiered tariffs to discourage people from using too much electricity.
- We can calculate the cost of using a single appliance by multiplying the power rating by the number of hours and the unit cost of electricity.

Concept Map

Use the following page to design your own concept map to summarise this chapter on the cost of electrical energy.



Cost of electrical
energy

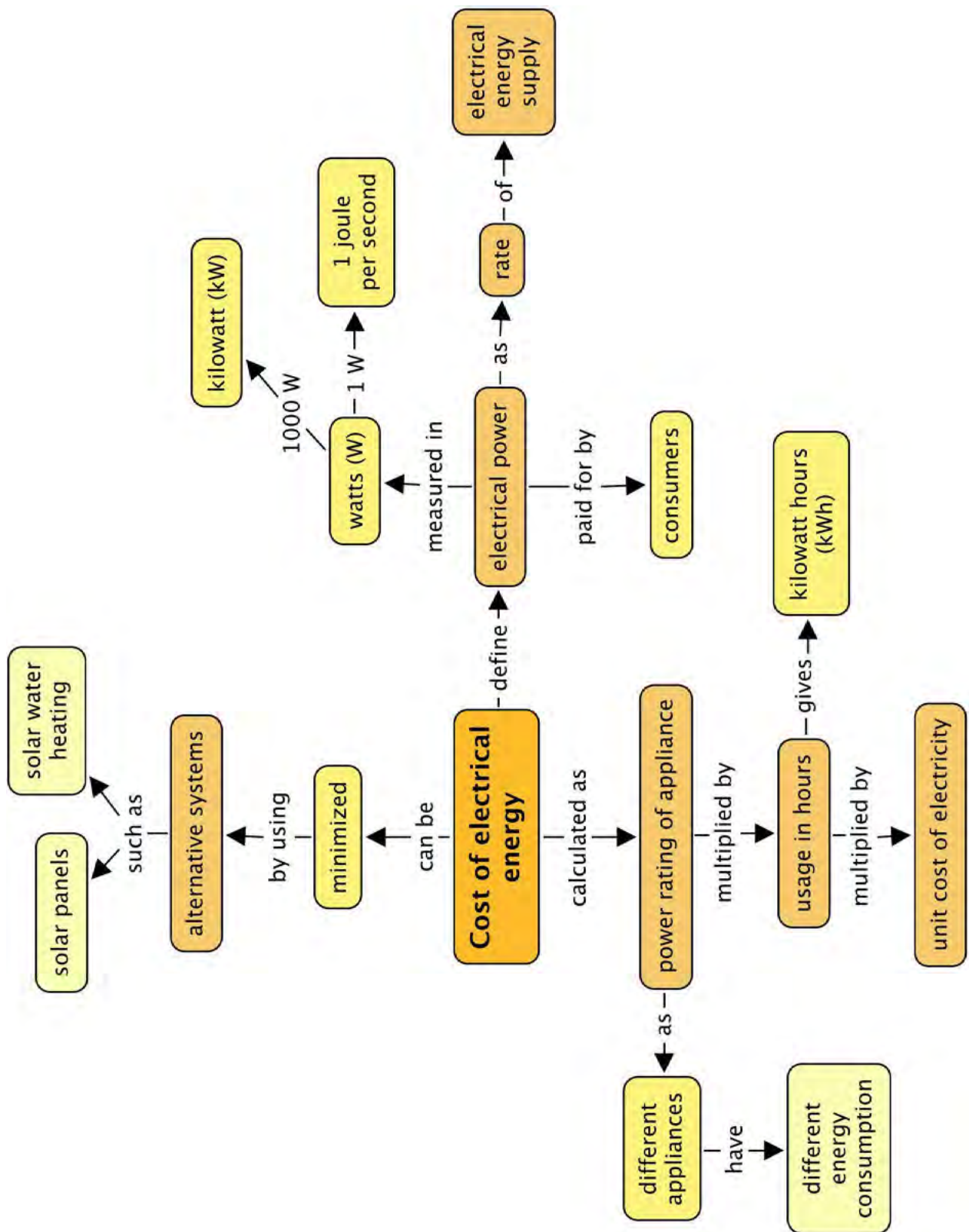



REVISION:

1. What is the power rating on the following two appliances? [2 marks]
 a) A frying pan.



- b) A fan.



- a) 1400 W
 b) 120 W

2. Refer to the table of power ratings for common appliances. List the appliances in sequence from those that use the least power to those that use the most. [2 marks]

Appliance	Power rating (W)
Stove	3600
Microwave	1200
Washing machine	2200
Kettle	2200
Fridge	230
Toaster	750
Energy saver globe	40
Incandescent light bulb	120
Vacuum cleaner	1600

Energy saver globe, incandescent light bulb, fridge, toaster, microwave, vacuum cleaner, washing machine, kettle, stove.

3. What is electrical power? Explain in your own words. [2 marks]
Learners should explain that it is the amount of electrical energy transferred per second.
4. Explain what is meant by 1 watt of power. [2 marks]
1 watt of power is equal to 1 joule of energy supplied in 1 second.
5. What does it mean that a stove has a power rating of 3600 W and a microwave has a power rating of 1200 W? Compare these two appliances in terms of the energy supplied. [3 marks]
This means that the stove uses more power than the microwave as the stove uses 3600 joules of energy per second, whereas a microwave uses 1200 joules of energy per second.
6. Complete the following table [8 marks]

Joules (J)	Kilojoules (kJ)
145	0,145
134 000	134
1 650	1,65
32 120	32,12
Watts (W)	Kilowatts (kW)
1 850	1,85
3 790	3,79
32	0,032
485	0,485

7. An electric iron is rated at 1500 W. If the iron is used for 3 hours every day, find the number of units of electrical energy it consumes in the month of February. [3 marks]
power rating = 1500 / 1000 = 1,5 kW
time = 3 x 28 = 84 hours
energy consumption = 1,5 x 84 = 126 kWh
8. An electric kettle is rated at 1000 W. If it is used for 1 hour every day, find the number of units of electrical energy it consumes for the month of August. [3 marks]
power rating = 1000/1000 = 1 kW
time = 1 x 31 = 31 hours
energy consumption = 1 x 31 = 31 kWh
9. Your house's electricity meter in March was 3456 and in April it was 4566.
 - a) How much electrical energy did your household use in that one month period? [2 marks]
 - b) If electrical energy is charged at 71,65 c/kWh, what will your bill be for that one month period? [3 marks]
a) Energy consumed = 4566 - 3456 = 1110 kWh
b) energy = 1110 kWh
price = 71,65 c/kWh
Cost = 1110 x 71,65 = 79531,5 cents = R795,32
10. A 120 W electric blanket is left on for 8 hours
 - a) How many kilowatt hours of electrical energy is used by the blanket? [3 marks]
 - b) If the unit cost of electricity is 71,65 cents, what is the cost, in rands, of

- using the electric blanket for 8 hours? [3 marks]
- a) *power rating = 120 W = 0,12 kW*
time = 8 hours
energy = power x time = 0,12 x 8 = 0,96 kWh
- b) *Cost = 0.96 x 71,65 = 68,784 cents = R0,69*
11. A 2600 W kettle in a school staffroom is used 8 times a day for five minutes each time.
- a) What is the total time that the kettle is switched on during each 5 day school week? [2 marks]
- b) How much energy is consumed to run the kettle for this period (in kilowatt hours)? [2 marks]
- c) If the cost of a unit is 71,65 cents, what is the cost of running the kettle for this period? [3 marks]
- a) *time = 8 x 5 x 5 = 200 minutes = 3,33 hours per 5 day school week.*
- b) *power rating = 2 600 W = 2,6 kW*
time = 3,33 hours
energy = 2,6 x 3,33 = 8,66 kWh
- c) *cost = 8,66 x 71,65 = 620,35 cents = R6,20*
12. If you had a prepaid electricity voucher with a value of R35, calculate the following.
- a) How long could you run a 230 W fridge for if electricity costs 71,65 cents per kWh. [5 marks]
- b) How long could you run six 60 W incandescent light bulbs? [5 marks]
- a) *cost = R35 = 3500 cents*
power rating = 230 W = 0,23 kW
price of electricity = 71,65 c/kWh
Number of available units (kWh) on voucher = 3500/71,65 = 48,85 kWh
time = energy/power = 48,85 kWh / 0,23 kW = 212 hours
- b) *Number of available units (kWh) on voucher = 3500/71,65 = 48,85 kWh*
power rating for one bulb = 60 W = 0,06 kW
power rating for six bulbs = 0,06 x 6 = 0,36 kW
time = energy/power = 48,85 / 0,36 = 135,69 hours
13. Which light bulb, 15 W CFL or an 8 W LED, would you choose to use? Explain your answer. [3 marks]
- Both light bulbs produce the same amount of light but because the power rating of the LED is lower, the cost of the electricity to run the light is less. The LED is cheaper to use. Learners may also mention that CFLs contain mercury while LEDs do not.*
14. A tumble dryer has a power rating of 4 500 W. How long did it take to dry a load of wet washing if electricity costs 71,65 cents per kWh and the cost of running the dryer was R4,84? [6 marks]
- cost = R4,84 = 484 cents*
power rating = 4 500 W = 4,5 kW
cost = energy consumed x price per unit
energy consumed = cost/price per unit = 484/71,65 = 6,755 kWh
time = energy/power = 6,755/4,5 = 1,5 hours

Total [62 marks]



GLOSSARY

acceleration:	the rate of change of velocity with time, as an object speeds up or slows down
alloy:	a mixture of different metals; the alloy will have properties from the different metals in the mixture
alternative energy:	a form of energy which is different to the main energy source used in the country
armature:	any moving part of an electrical machine in which a current is produced by a magnetic field
attraction:	a force which causes objects to move towards each other
battery:	a group of two or more electric cells connected together
circuit breaker:	like a fuse, the circuit breaker switches off the current in the case of an electrical fault
compression:	a force which attempts to flatten or deform (squash) an object
conductor:	a substance which allows heat, sound or electric charge to pass through it easily; a good conductor allows free passage whilst a poor conductor allows partial passage
contact force:	objects are in contact with each other and exert forces on each other
deformation:	to cause an object to change its shape
delocalised:	not limited to a particular place, free to move
earth leakage:	is a circuit breaker which will switch off all the electricity to a household or business if there is an electrical fault
earthing:	a circuit is earthed when there is a direct connection to the ground; this connection is usually through the earth wire in an electrical socket
electric cell:	a system in which chemical reactions occur to generate electricity
electric charge:	the physical property of matter that causes it to experience a force when close to other electrically charged matter; there are two types of electric charges: positive and negative
electric current:	the rate of flow of charge in an electric circuit
electrical appliance:	an electrical device
electrical power:	the rate at which energy is transferred
electrode:	an electric conductor used to make contact with a non-metal part of the circuit, such as a copper coin or iron nail in a lemon, or zinc or copper plates in a cell
electrolyte:	a special type of solution which is able to conduct electricity
electrostatic force:	force of attraction or repulsion between electrostatic charges

Eskom:	Electricity Supply Commission of South Africa
estimate:	a value which is not exact
excess:	more than is needed
field forces:	non-contact forces
force:	a push or a pull exerted on an object by an agent
free-fall:	when the only force acting on an object is the gravitational force
friction:	a force that opposes or tries to oppose the motion
fuse:	a safety device which switches off an appliance if the current in the circuit is too strong
generator:	a machine which produces an electric current by rotating a conducting coil in a magnetic field
gravitational acceleration:	a measure of how an object changes its speed every second; on Earth gravitational acceleration is $9,8 \text{ m/s}^2$
gravitational force:	force of attraction between two objects because of their masses
half cell:	a setup that consists of an electrode surrounded by an electrolyte; for example, a zinc half cell could consist of a zinc metal plate (the electrode) in a zinc sulphate solution (the electrolyte)
illegal:	forbidden by law; against the law
input energy:	the energy that enters a system and is altered by the system to produce an output energy
kilowatt-hour:	a unit of energy that is useful for measuring energy consumption
LED:	light emitting diode (a diode is an electrical component that only allows current flow in one direction only and blocks the flow in the opposite direction)
lumens:	the unit of measurement for light output
magnet:	a material with a strong magnetic field around it
magnetic force:	a force exerted by a magnet on a ferromagnetic material
magnetic material:	a material which is strongly attracted to a magnet
mass:	a measure of the amount of matter making up an object
motor:	a device that can convert electrical energy into mechanical energy
national electricity grid:	the network of cables, pylons and transformers which transfer electricity throughout the country
net force:	the overall result of several forces acting on the same object at the same time
newton:	the unit of measurement of a force
non-contact force:	a force which can act over a distance without touching the object experiencing the force
normal force:	the reaction force of the surface to an object
nuclear fission:	when an atomic nucleus is split to produce two separate atomic nuclei; a large amount of energy is released during the separation

nuclear fusion:	when two small atomic nuclei are combined to produce one atomic nucleus; a large amount of energy is released as the nuclei are fused together
nuclear power:	the use of nuclear reactions to generate useful heat and electricity
ohm:	unit of measurement for resistance (Ω)
output energy:	the energy that a system produces due to an input energy
potential difference:	the difference in potential energy per charge between two points in an electric circuit
power consumption:	the amount of electrical power used by an appliance or household
power station:	a system for generating electricity
power surge:	a sudden increase in the voltage somewhere in an electric circuit which can disrupt the power supply
provision:	supplying something
pylon:	a large vertical steel tower which supports electrical power cables
radioactive:	the spontaneous release of a stream of particles or electromagnetic waves from an unstable nucleus
rate:	a ratio where one quantity is compared to time, for example km/h or m/s
repulsion:	a force that causes objects to move apart
reset:	to start something again from its start
resistance:	the opposition to the flow of electrical current through a material
resistor:	an electrical component in a circuit that opposes the flow current in the circuit
rheostat:	a variable resistor. The amount of resistance offered by the rheostat can be adjusted
salt bridge:	a device that is used to connect the two half cells in an electric cell so that their electrolytes do not mix
Sankey diagram:	a Sankey diagram is used to show the difference between input and output energy
series circuit:	a circuit which provides only one path for electric current
short circuit:	a short circuit is a low resistance path which causes all of the current to flow through the low resistance path and not through the rest of the circuit
speed:	the rate of change of distance of an object
survey:	information gathered from a wide range of people
tariff:	the amount of money charged for every unit
tension:	the force transmitted through a rope, string or chain. It is a contact force
tiered tariff:	the amount of money charged changes if more units are used; there are different levels of tariffs
transformer:	an electrical device to transfer energy between two parts of the circuit in the national electricity grid
transmission lines:	power cables which transmit electricity across the country

turbine:	a machine which consists of a large wheel that is made to turn using steam
variable resistance:	resistance which is able to be changed
VAT:	Value Added Tax; this is a tax imposed by the government on all consumable goods
velocity:	the rate of change of the position of an object, specifying the object's speed and direction
voltage:	the difference in potential energy per charge between two points in an electric circuit
watt:	unit of measurement for power; 1 watt is 1 joule per second
weight:	the gravitational force of attraction exerted on an object by the Earth (or Moon or any other planet)

What can you transform our Earth into? Be curious!





Download more resources like this on ECOLEBOOKS.COM





PLANET EARTH AND BEYOND

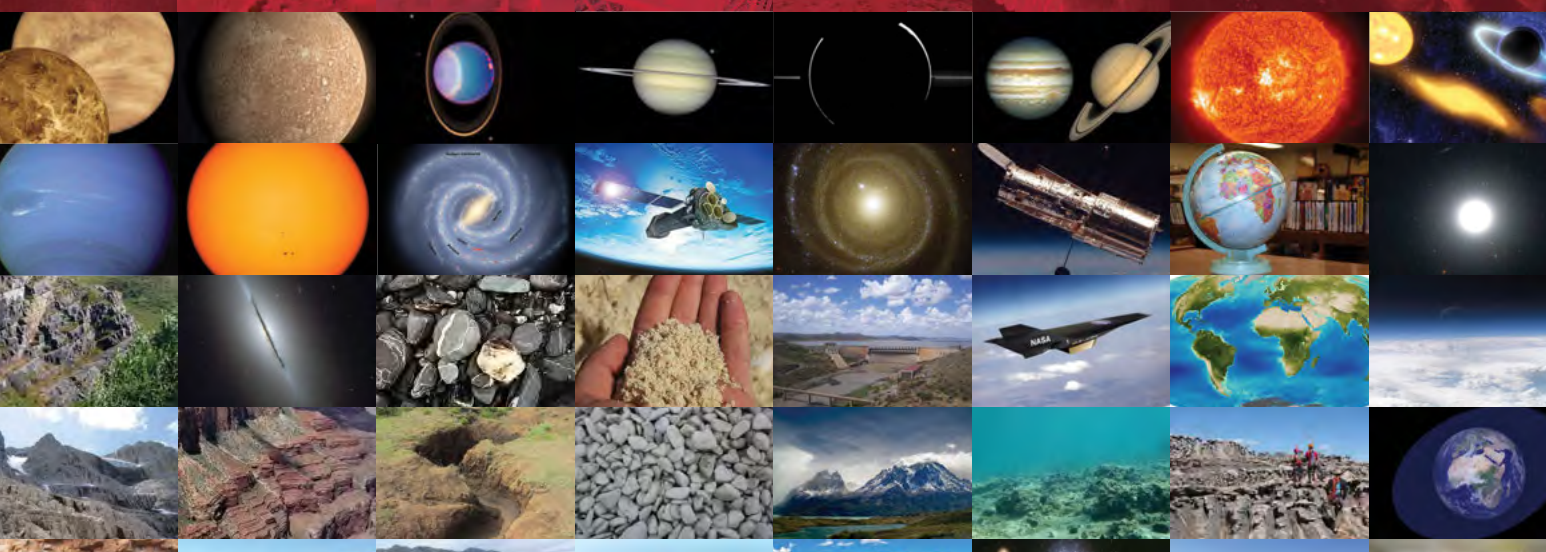

DOWNLOAD MORE RESOURCES LIKE THIS ON ECOLEBOOKS.COM

TEACHER'S NOTE**Chapter overview**

1 week

In Grade 7 the learners investigated the relationship between the Earth and the Sun, day and night, the seasons and how the Sun's energy is utilized by plants, and how fossil fuels are formed. In Grade 8 they looked at the Earth as part of a bigger system, namely the solar system. This year they will study the Earth as a system itself and the different parts that make up this system. 'Systems' is an important theme that runs through all of science and here we learn about systems in yet another application.

In the first chapter the parts of the Earth's system (the spheres) and how the parts work together are examined. The hydrosphere and water cycle were studied in earlier grades and revised here. The biosphere is also studied throughout Natural Sciences. The remaining two spheres are investigated this year - the lithosphere (Chapter 2 and 3) and the atmosphere (Chapter 4). In the lithosphere we look at how rocks are formed, the minerals found in rocks, how we extract these minerals and the impact our interactions with the lithosphere has on the other spheres. The layers of the atmosphere are studied in the last chapter.

The study of the lithosphere and atmosphere links up with what learners have learnt about the atom and compounds in the Energy and Change section, as well as phases of matter and knowledge about gases, like oxygen, carbon dioxide and methane.

This will prepare learners for study in Grade 10 and further, where the different branches of Natural Sciences separate into Life Sciences (Biology and Environmental Sciences), Physical Sciences (Chemistry and Physics) and Earth Sciences (Geography).

Concept maps: The concept maps in these workbooks were created at Siyavula using an open source programme called CMapTools. You can download the programme from this link if you would like to use it to create your own concept maps.¹ cmap.ihmc.us/download/

Citizen science offers you a free, easily accessible and inspiring opportunity to bring real science into the classroom. Find out more about incorporating real science into your classroom with Zooniverse citizen science projects at ZooTeach:² www.zooteach.org/. ZooTeach is a website where teachers and educators can share high quality lesson plans and resources that complement the Zooniverse citizen science projects.

1.1 Spheres of the Earth (3 hours)

Tasks	Skills	Recommendation
Activity: Exploring the spheres of the Earth	Observation, data collection, writing	CAPS suggested
Activity: Interaction between the spheres	Application	CAPS suggested
Activity: Identifying the interactions of the spheres on Earth	Interpreting information, analysis	CAPS suggested
Activity: Upsetting the balance	Analysis, Application, Prediction	Suggested

KEY QUESTIONS:

- What are the different parts of the Earth?
- How do these parts interact?
- Why can we refer to the Earth as a system?

In Grade 7 you learnt about the relationship between the Earth and the Sun and the importance of the Sun for life on Earth. In Grade 8 you looked at the relationship between the Earth and other planets in our solar system. This year we will look at the Earth as a system and all the parts of this system.

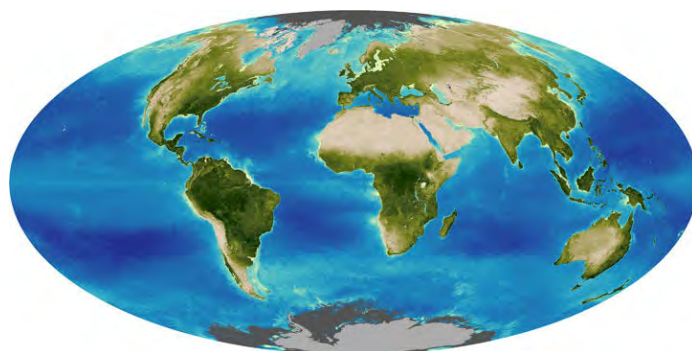

1.1 Spheres of the Earth

You have learnt about systems and cycles throughout your studies of Natural Sciences over the past 5 years. For example, you have learnt about the life cycle of a butterfly, energy systems in food webs or electric circuits, and the solar system. Much of what we observe in nature is part of one or many systems or cycles. In this chapter we are going to learn about the Earth as a closed system and the four different parts (spheres) of this system.



VISIT

The story of our planet.

bit.ly/1dhCQLy

Earth's four spheres

The Earth is made up of four systems, or spheres. The biosphere (life), the lithosphere (land), the hydrosphere (water) and the atmosphere (air). On Earth land, water, air and life interact with one another. As humans, we are also part of this interaction. There is a fine balance between these four systems - if the one becomes altered, it has an effect on all the others.

The Biosphere

The biosphere includes all life on Earth - plants, animals and humans. Most of what is studied in Life and Living is about the biosphere. The biosphere also includes life in the oceans, and under the soil.

For example bacteria living on decaying plant material and the smallest sea creatures and plants are part of the biosphere. Almost all the life on the planet is found between 3 meters below the surface of the Earth, up to 30 meters above the ground, and in the top 200 meters of the oceans.



Biosphere 2 is a man-made research centre in America, in the Arizona Desert, where scientists have built a large enclosed artificial biosphere.

VISIT

Read more about Biosphere 2 here bit.ly/1eZtvZj and watch a TED talk on living in Biosphere 2 for 2 years. bit.ly/1eZtG70

TEACHER'S NOTE

An interesting study was done by a research team in Arizona, USA, where they built a self-contained facility called Biosphere 2 to study the relationship between living things and their environment. The facility had absolutely no contact with anything on Earth, except the Sun. The first group of people lived inside, without exiting, for 2 years. The project wasn't as successful as they planned and they realised that we do not know enough about the interactions between the systems on Earth. The project is still ongoing and used for extensive research. More information is available here (³ bit.ly/1eZtvZj). This can be given as an extension reading for your learners.

All living things and their habitats form part of the biosphere. The following photographs provide examples of different organisms in their habitats, living in the biosphere.



A grasshopper



Dolphins in the sea.

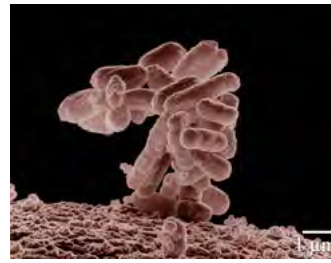

Escherichia coli bacteria.



Sugar cane fields.



An earthworm in the soil.



Limpets in a rock pool.

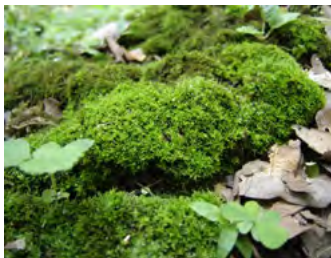

Moss in a forest.

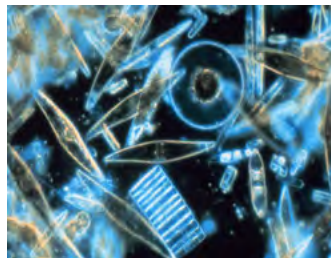

Phytoplankton in the sea.



A blue crane on the river's edge.



Mushrooms in a field.



Children at school.

VISIT

Something interesting - the biggest organism on Earth.

bit.ly/Hr5XR9

The hydrosphere

The hydrosphere includes all water on the planet - the oceans, lakes, rivers, groundwater, rain, clouds, glaciers and ice caps. About 70% of the surface of the Earth is covered with water. The oceans contain most of this water, with only a small portion of it being fresh water. All the water on Earth forms part of the hydrosphere.



An iceberg.



A river.



Clouds.

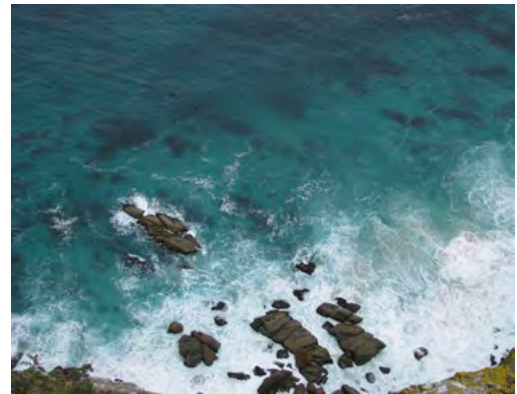

The sea.



The atmosphere

The atmosphere includes all the air above the surface of the Earth all the way to space. All the gases that are present in the air are included in the atmosphere. Most of the atmosphere is found close to the surface of the Earth where the air is most dense. The air contains 79% nitrogen, less than 21% oxygen, and a small amount of carbon dioxide and other gases. We will look more closely at the atmosphere later on in this chapter.

VISIT

Which came first - the rain or the rain forest?

bit.ly/1a9Twx1

VISIT

Blue planet - a look at water on our planet.

bit.ly/16GgYEL



The top of Earth's atmosphere.

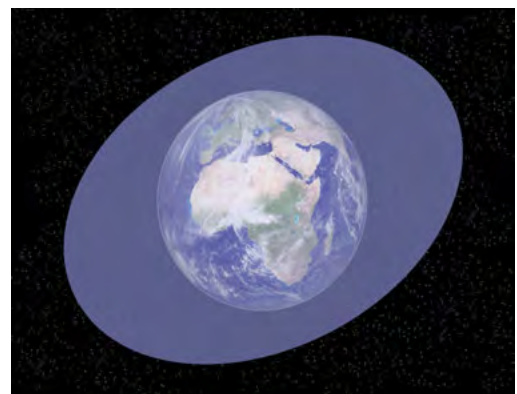

The region of space occupied by Earth's atmosphere.

The lithosphere

The lithosphere includes the Earth's crust and the upper part of the mantle. All mountains, rocks, soil and minerals included in the Earth's crust are part of the lithosphere. Even the seafloor is part of the lithosphere, because it is also made up of sediments of sand and rock. We will look more closely at the lithosphere in the next section.

All the rocks, soil and sand on Earth form part of the lithosphere, as shown in the following photographs.



Rock formations.



Sand dunes.



Soil.

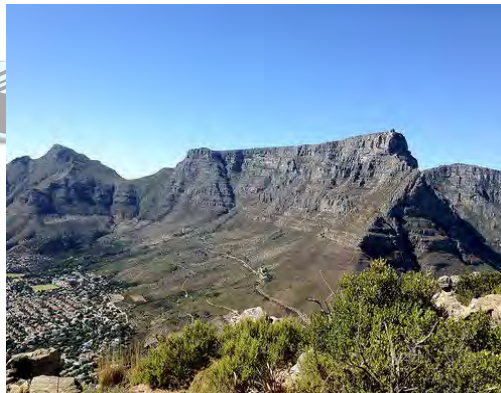

Mountains.



Minerals.



Seafloor.

TAKE NOTE

The word 'sphere' is used in Mathematics to describe a round shape. The Earth has the shape of a sphere. When we talk about the four spheres of the Earth, we do not mean a ball shape, but rather we refer to the touching and overlapping layers within Earth.

The following collage shows the four spheres of the Earth.



VISIT
Watch this video for a summary of the four spheres of the Earth.
bit.ly/1cmwBcn

TEACHER'S NOTE

This is a very short (2:07 min) video of the four spheres of the Earth.
⁴ abt.cm/16Ghu5N

It summarises what was covered so far in this chapter. If you have facilities, this can be played to the class at the end of the lesson. If not, the content is covered in the text in this section.



ACTIVITY: Exploring the spheres of the Earth

INSTRUCTIONS:

1. Find an example on your school ground or at home where all four spheres are present. For example a tree growing in your garden.
2. Describe the location and what you have included in your example.
3. Identify each of the spheres in a short paragraph.
4. Your teacher might also ask you to present your example as a poster with illustrations and short descriptions, identifying each sphere.

TEACHER'S NOTE

This activity is only about identifying the different spheres. The next section will look at the interactions of the spheres. You can use the examples which the learners have chosen to build the next lesson upon.

Learner-dependent answer. The learners needs to be able to identify the various spheres within the example they have chosen, for example: A plant in a pot.



The soil/sand is part of the lithosphere. The soil contains water, which is part of the hydrosphere, the plant is part of the biosphere and the air around the plant is part of the atmosphere. The plant takes in carbon dioxide and gives off oxygen when photosynthesis takes place, and the reverse during respiration. Oxygen and carbon dioxide are part of the atmosphere.

Alternative options are: A tree growing on the school grounds, a frog in a pond, etc.

Instead of being a written task, you can also ask learners to do a small poster with a drawing of their example, with annotations describing the different sphere.

Interaction between the spheres

TEACHER'S NOTE

This section can be covered by doing the activity and giving learners the opportunity to discover the interaction between the different spheres. The activity also links up with the previous activity where they explored the different spheres.

The different spheres of the Earth are closely linked and interact with each other. Let's investigate this in the following activity.

VISIT

Fly along with NASA satellites and view the Earth with this interactive website.
bit.ly/17TuG7u

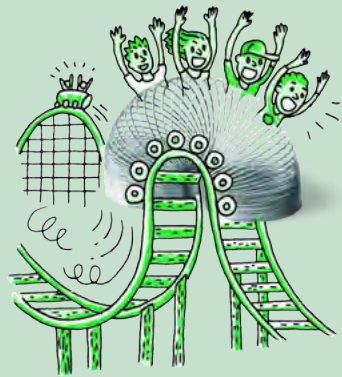

ACTIVITY: Interaction between the spheres

INSTRUCTIONS:

1. Study the photo of thorn trees on the savannah.
2. Answer the questions that follow.



Thorn trees.

QUESTIONS:

1. Identify the four different spheres of the Earth in the example.
Biosphere - the tree, grasses and other plants
Lithosphere - the sand, rocks and minerals in the soil
Hydrosphere - the groundwater (or water in the soil)
Atmosphere - the air around the tree
2. What will happen if the trees do not get enough water?
They will wither and die. They need water to photosynthesise.
3. Describe the interaction between the hydrosphere and the biosphere in this example?
The trees and other plants (biosphere) interact with the hydrosphere when they absorb water through their roots.
4. What will happen if the carbon dioxide levels change dramatically?
The plants will not flourish, their growth will be affected as photosynthesis will be affected. Depending on how dramatically levels change, the plants might die.
5. Describe the interaction between the atmosphere and the biosphere in this example?
The carbon dioxide in the atmosphere is needed by the plants for photosynthesis. The plants also produce oxygen, which is given off into the atmosphere.
6. Is there any interaction between the lithosphere and the hydrosphere in this example?
Yes, the minerals (lithosphere) in the soil are dissolved in the groundwater (hydrosphere). The groundwater (hydrosphere) also wets the soil (lithosphere) so that the roots of the plants can absorb it.
7. Use the example you have chosen in the previous activity (Exploring the spheres of the Earth) and describe three different interactions between the different spheres.
Learner-dependent answer. Any three combinations can be described. For example:
 1. *The pot plant (biosphere) absorbs water (hydrosphere) through its roots and uses it for photosynthesis.*
 2. *The plant (biosphere) uses carbon dioxide (atmosphere) and gives off oxygen (atmosphere) during photosynthesis.*
 3. *The plant (biosphere) uses the soil, sand and rocks (lithosphere) to anchor itself.*
 4. *The minerals (lithosphere) dissolve in the groundwater (hydrosphere) so that the plant (biosphere) can absorb it.*

TEACHER'S NOTE

The easiest interactions to describe are those between the biosphere and the other spheres respectively. In the next activity the idea is to explore the interaction between the other spheres as well.

There is an interaction between the tree and other plants (biosphere) and the air (atmosphere) as they use carbon dioxide from the air during photosynthesis and give off oxygen. There is an interaction between the plants (biosphere) and the soil (lithosphere) when they absorb water (hydrosphere) and minerals (lithosphere) from the soil (lithosphere). The soil is also used to anchor the plants. The tree (biosphere) produces flowers and then fruit. Animals eat the fruit and the leaves of the trees and other plants.

ACTIVITY: Identifying the interactions of the spheres on Earth

TEACHER'S NOTE

For this activity let the learners discuss amongst themselves first. The activity can be part of your teaching. The idea is that the learners discover the interactions by themselves (with your guidance) before you 'give them the answers'. Give them 5 minutes to talk to each other and then another 10 minutes so that they can complete the map. Afterwards the interactions can be discussed as a class.

They might need some assistance in how to complete the map. One example is given. It might be necessary to do one more example as a class before they try it on their own.

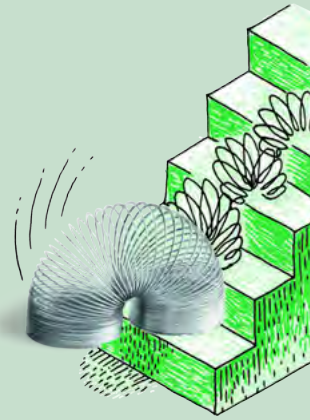

INSTRUCTIONS:

1. The picture below is of the dam wall that was built for the Gariep Dam on the border between the Free State and the Eastern Cape. The wall is used to generate hydroelectric power, as we learnt about in Energy and Change.
2. Answer the questions below.



Gariep Dam in the Orange River.

QUESTIONS:

1. Discuss in pairs all the possible interactions between the spheres of the Earth.
2. Work on your own to complete the following map. Write a description of the interaction on each of the arrows. One example was done for you: There is an interaction between the lithosphere and the atmosphere in that the wind (moving air) will cause erosion of the rocks surrounding the dam. Where possible include more than one interaction on the arrow linking the spheres.

TEACHER'S NOTE

Learner-dependent answer. Some possible solutions are given below. Learners could also include other options.

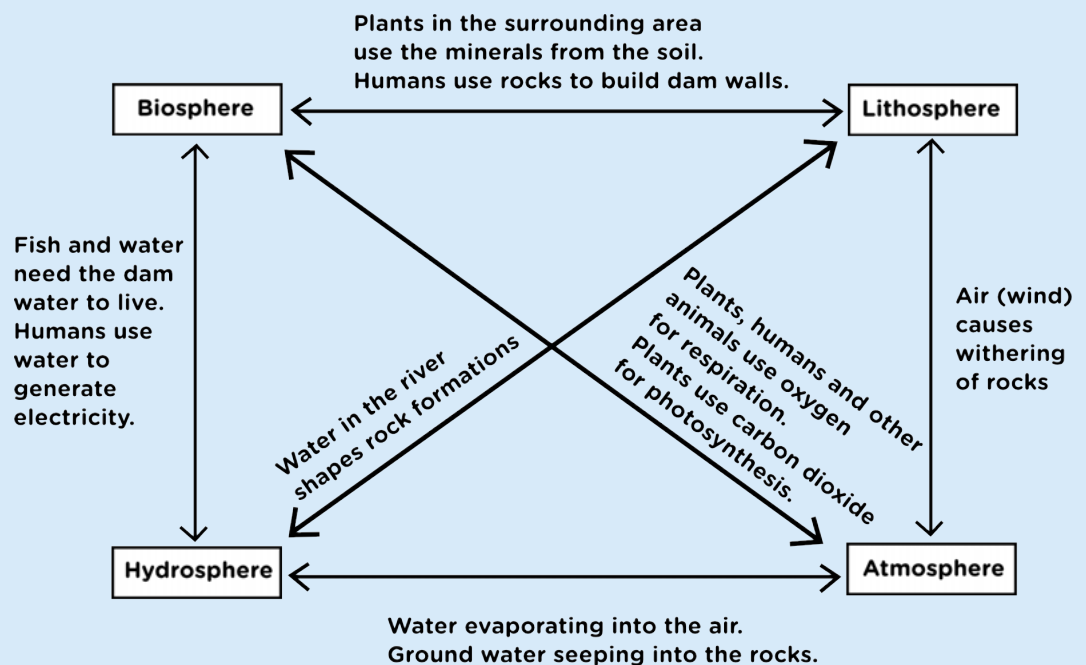

The pictures below show how crops are harvested. The process of growing and harvesting crops are good examples of how the different spheres of the Earth interact. The hydrosphere provides water for the crops to grow. The soil provides minerals for the crops to give a good yield. The air provides carbon dioxide to the crops for photosynthesis and in return the plants give off oxygen to the air. The people (biosphere) make use of the materials from the lithosphere to build machinery or make sharp tools (metal from the lithosphere) for cutting wheat for example. Many interactions play a role in ensuring a healthy crop.



Growing wheat in fields.



A harvester cutting and gathering the wheat.

Upsetting the balance

Let's look at our example of the thorn trees in a savannah ecosystem again. If the balance in any part of the system is changed, it affects the whole system. For example, if there is not enough water, the tree won't flourish and produce fruit (in this case, seed pods). If the air is polluted, it affects the availability of carbon dioxide to the tree. If there are not sufficient minerals in the soil, the plants cannot grow.

ACTIVITY: Upsetting the balance

TEACHER'S NOTE

This activity will require the learners to think and apply what they have learnt in the section so far as well as knowledge from previous chapters. You could use the activity to guide a classroom discussion, or let the learners work in pairs or small groups. The important message for this section is that a disturbance in one of the spheres has an effect on all the others. The disturbance can be due to natural causes, or due to the influence of human interactions. As humans we have a responsibility to understand how the interactions work, what impact humans have on the planet, and what we need to do today to make life possible for future generations.

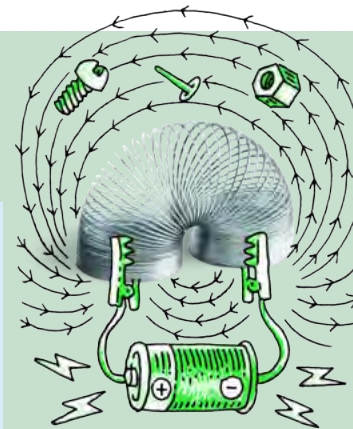

Interactions between the spheres of Earth.

TAKE NOTE

Think back to the definition of a system which we discussed in Energy and Change. A system is a set of parts working together where a change in one part affects other parts. This also applies when talking about the Earth as a whole system.

QUESTIONS:

1. Identify the four spheres of the Earth from the photograph.
Biosphere - plants
Hydrosphere - river and snow
Lithosphere - rocks, soil, mountains
Atmosphere - air
2. Predict what the influence of the following scenarios on each sphere would be:
 - a) Large deposits of coal are found here.
 - b) The average temperature rises considerably as a result of global warming.
 - a) *Learners could suggest that the ecosystem would be destroyed as the earth would be mined, plants and animals would lose their habitat, the water could be polluted from the mining, as well as the atmosphere from exhaust gases from vehicles and machinery.*
 - b) *Global climate change would follow, for example, the snow would melt, the river might dry up, the plants and animals would suffer from an increase in average temperature.*
3. What is our responsibility as humans in the two scenarios in the previous question?
Learner-dependent answer. Learners must discuss this and write down some of their thoughts. Some points to raise include being environmentally aware of our impact, assessing our impact before embarking on a project such as a new mine, looking for alternative solutions, such as renewable energy sources.

VISIT

The concept maps in your workbooks were created at Siyavula using an open source programme. You can download it from this link if you want to use it to create your own concept maps for your other subjects and for next year. bit.ly/1aR0oTN

As you have seen in the activity, all the spheres on Earth interact closely with each other. When there is a change in one of the spheres, the others are also affected. The changes can be due to natural causes, for example floods or earthquakes, but more often these changes are due to human influence. As human we have a responsibility to understand the interactions on Earth and to look after the planet so that future generations will be able to live on Earth.

SUMMARY:

Key Concepts

- The Earth is a complex system where all the parts (spheres) interact.
- The Earth consists of four spheres: the lithosphere, the hydrosphere, the atmosphere and the biosphere.
- The lithosphere consists of solid rock, soil and minerals.
- The hydrosphere consists of water in all its forms.
- The atmosphere is the layer of gases around the Earth.
- The biosphere consists of all living plants and animals and their interactions with the rocks, soil, air and water in their habitats.

Concept Map

Use the following page to draw your own concept map for this chapter.



Spheres of the Earth

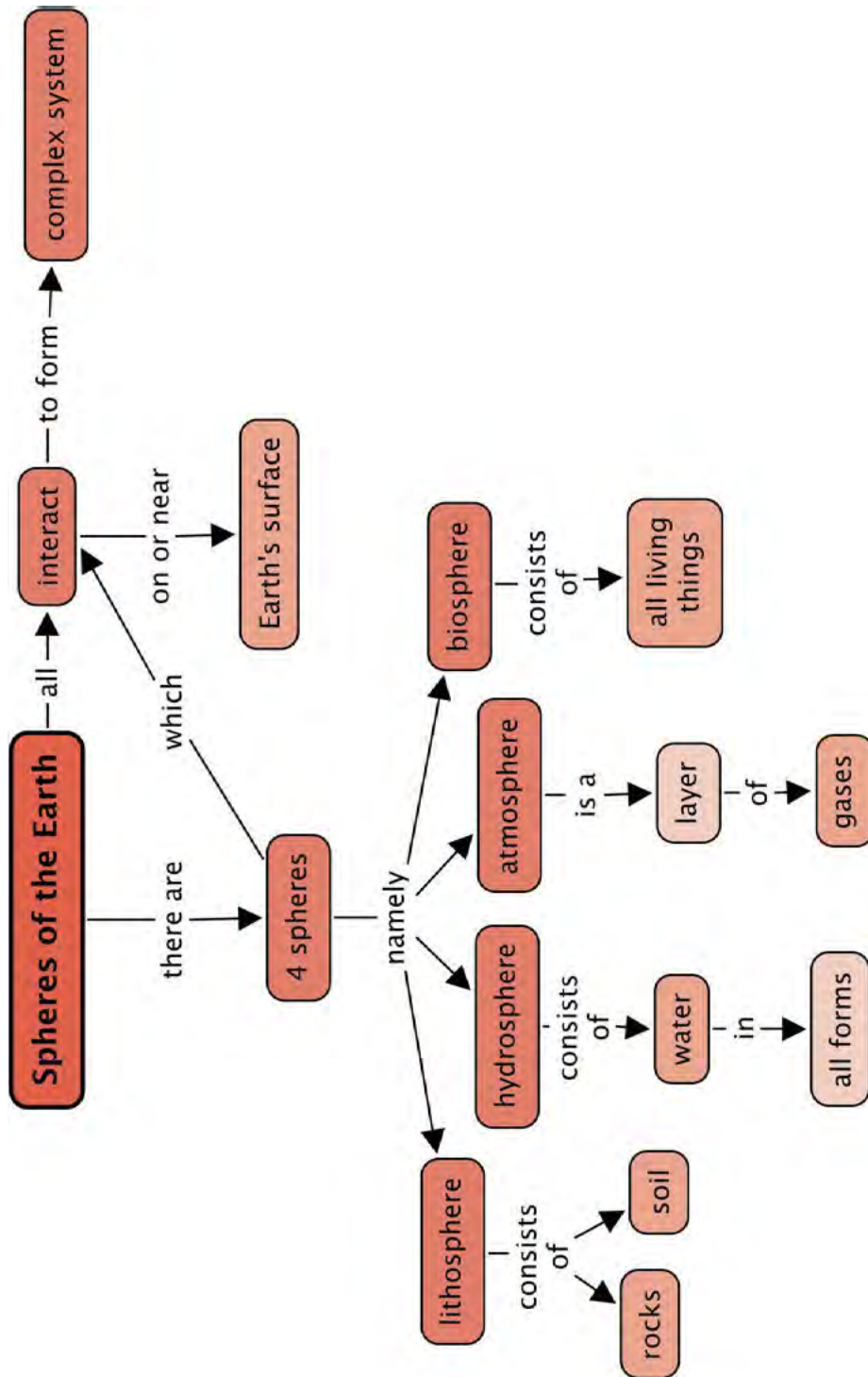

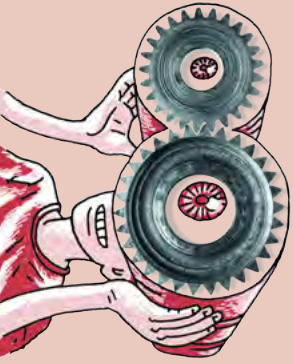

REVISION:

1. Identify the four spheres of the Earth. What is each sphere composed of? List only three components for each. [8 marks]

The lithosphere consists of solid rock: mountains, sand and minerals.

The hydrosphere consists of water in all its forms: ice, snow, lakes, dams, rivers and the ocean.

The atmosphere is a layer of gases around the Earth, for example carbon dioxide, oxygen and nitrogen.

The biosphere consists of all living plants and animals and their interactions with the rocks, soil, air and water: all plants and animals on land, underground and in water - plants, animals, and humans are part of the biosphere.

2. How does the lithosphere interact with the hydrosphere, biosphere and atmosphere in the photographs below? [6 marks]



a)

A large open copper mine.

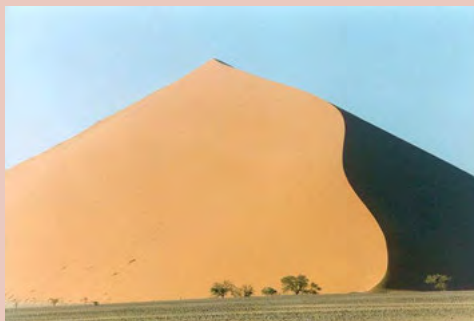

b)

A sand dune in the Namib Desert

- a) *The copper (mineral, lithosphere) in this area is extracted by humans (biosphere) through mining activity.*

Mining activities need a lot of water (hydrosphere).

A lot of dust is created during mining activities polluting the air (atmosphere). Additional carbon dioxide is also formed due to the mine trucks driving in and out of the mine daily. Mines use a lot of energy to drive the machinery and electricity generation has negative effects on the environment.

The shape of the landscape (lithosphere) was changed due to the actions of humans (biosphere).

b) *The sand (lithosphere) is blown by the wind (moving air, atmosphere) to form sand dunes.*

Very little water (hydrosphere) is available in desert areas. On occasion it will rain (hydrosphere), or there might be underground water (hydrosphere) sources which plants (trees at the foothills of the dune, biosphere) will use. Some desert animals like insects or snakes (biosphere) may be found under the sand (lithosphere) which provides them with protection from the heat of the Sun.

3. You have a wet towel which you hang outside to dry. Describe and compare the interaction between the hydrosphere (water droplets on your towel) and the atmosphere (temperature and air movement around you), if you live in a dry area, and if you live in a humid area. [2 marks]

In a dry area, evaporation of water droplets (hydrosphere) take place fast because the air (lithosphere) is quite dry and the air temperature is high.

Alternatively, in a humid area, evaporation will not take place as fast.

Total [16 marks]



TEACHER'S NOTE**Chapter overview**

2 weeks

The focus for this chapter is the lithosphere and the processes involved in its formation. The lithosphere is part of a larger sphere called the geosphere. The geosphere consists of the three concentric layers of the Earth: the core, the mantle and the crust. The lithosphere refers to the outer part of the geosphere, which includes the upper part of the mantle and the crust. The lithosphere is also part of the Earth where the rock cycle is found.

The first section on 'What is the lithosphere?' gets learners to investigate their environment first, discovering that the lithosphere is found all around them. We then step back and look at the concentric layers which make up the Earth. This gives the background information need to introduce the rock cycle which involves the upper part of the mantle and the crust. The three rock types are introduced, which is followed by investigating what rocks are really made of - minerals. This sets the scene for the next chapter on mining the mineral resources.

2.1 What is the lithosphere? (2 hours)

Tasks	Skills	Recommendation
Activity: Investigating stones	Observation, writing, describing	CAPS suggested
Activity: Build a 3D model of the Earth	Design, making a model, applying knowledge, translating information	Optional This can be used as a project to be conducted throughout the term.
Activity: The layers inside the Earth	Classification, comprehension	Suggested

2.2 The rock cycle (4 hours)

Tasks	Skills	Recommendation
Activity: Summarising the rock cycle	Recall, comprehension	CAPS suggested
Activity: Explaining the rock cycle	Writing, comprehension	CAPS suggested
Activity: Building a model of the formation of sedimentary rock	Making a model, translating information	CAPS suggested

Tasks	Skills	Recommendation
Activity: Comparing the properties of igneous rocks	Comparing, observation, application	Optional
Activity: Classifying rocks	Classification, organising information, making deductions	Optional extension
Activity: What minerals are found on Earth?	Researching, reading, writing	CAPS suggested



KEY QUESTIONS:

- What does the centre of the Earth look like?
- Why is it important to know about the structure of the Earth?
- Why is there so much variety in the rocks you see around you?
- How do rocks form?
- Why do we need to know about rocks?
- Why are rocks important?



The Earth is a system consisting of many parts. In the previous chapter we looked at how these parts or spheres interact. In this section we are going to look more closely at one of these spheres, namely the **lithosphere**.

2.1 What is the lithosphere?

On Earth, water, air, stone and life interact. Let's think about the stone part of this statement. Where on Earth do we find stone? What are the different forms of stone that are found on Earth? Why is it important to know about this part of the Earth? Let's investigate these questions.



Sand.



Pebbles.

TAKE NOTE

'lithos' comes from the Ancient Greek word meaning 'stone'.



Stones.



Large boulders.



ACTIVITY: Investigating stones

TEACHER'S NOTE

During this activity learners will be required to observe carefully and put their observations into words. Encourage learners to look carefully and to capture as much detail as possible.

This activity can be done as an introduction to the section, before the content is discussed. Learners need to be asked before the lesson to bring these items to school. Some learners might be tempted to bring in pieces of brick and cement as examples of rock. Make sure to point out to learners that concrete and brick are made-made materials, although they have similar properties to rocks.

Alternatively learners can be sent out onto the school grounds to find the items (about 10 minutes). You could also bring items to school yourself, ensuring that there are at least 4 items per learner. Otherwise, you could place the different items at different stations (for example, 10 similar stones at station 1, 10 sand samples at station 2, etc.) and let the learners move from one station to the next. Each learner will then have his/her own stone to observe at each station. Give them 3 minutes at each station to do the observations. Learners can also attempt to crush some of the samples using a hammer and by wrapping the sample in paper towel to avoid pieces flying off in different directions. This can also be performed outside.

If learners are not able to bring stones to the classroom, the pictures provided in this section can be used. Use this as a last resort only.

The aim of the activity is for the learners to examine real artifacts and practice writing down their observations. They should realise that all the different types of stone form part of the lithosphere, including sand which is made from stone worn down by wind and water. The lithosphere is found all around us.

The activity can lead into a discussion of one or more of the following questions:

TEACHER'S NOTE

1. What types of stone found on Earth have we not collected in the activity? (molten rock, rock from the seafloor, etc.)
2. What do we use the lithosphere for? (minerals, fuels, plant nutrients, building materials, etc.)
3. What is rock or stone actually made of? Learners might say sand. If so, the follow-up question is 'What is sand made of?' Learners might not have the answer here. The idea is not to give them the answer yet, but to keep this as an open question which will be answered at the end of this chapter and the next chapter on mining the lithosphere. The activity is meant to be exploratory and not necessarily meant to provide the answers at this stage. It sets the scene for the two major topics: Different types of rocks (the rock cycle, Chapter 2) and the minerals found in rocks (what they are and how we mine them, Chapter 3).

MATERIALS:

- magnifying glasses
- hammers
- paper towel
- samples collected, as described below

INSTRUCTIONS:

1. Collect the following items and bring them to school: sand, pebbles, a small stone/rock, a larger rock.
2. When you collect sand, stones or rock, look for the samples that look interesting and different and bring these to class.
3. Find at least four different items from different locations.
4. Study the different samples and complete the following table. If you have magnifying glasses available, use these to study the detail of the different samples.
5. Wrap some of the samples in paper towel and see if you can crush them with a hammer. Your teacher might instruct you to do this outside.

	Location Describe where you have found your sample.	Shape and colour Describe the size, shape and colour	Texture Describe the texture and hardness.	Composition Is it made of more than one material? Describe what it is made up of.
Sand				
Pebble				
Small stone/rock				
Larger rock				

TAKE NOTE

When we look at the **composition** of something, we look at what it is made up of.

TEACHER'S NOTE

An example of what learners might write for 'Sand' is given below.

	Location Describe where you have found your sample.	Shape and colour Describe the size, shape and colour	Texture Describe the texture and hardness.	Composition Can you see more than one part? Describe what it is made up of.
Sand	At building site next door to our house.	The sand has small round grains of about 1 mm in diameter on average. It is cream coloured with some darker brown grains.	The grains are all more or less the same size. The sand is dry so it feels smooth and soft. The grains are hard, but break up even further when I hit it with a hammer.	All the grains look the same, except for the variations in colour. The grains are not connected/stuck to each other and are free flowing.



In the last investigation you would have seen a lot of variety amongst the types of stone that are found in the area around your school. There is variation in shape, colour and texture amongst the different rocks on Earth.

VISIT
The strangest geological formations on Earth.
bit.ly/1cmrQzw

The lithosphere consists of all the mountains, rocks, stones, top soil and sand found on the planet. In fact, it also includes all the rocks under the sea and under the surface of the Earth. The lithosphere is found all around us and we interact quite closely with it every day.

Inside the Earth

TEACHER'S NOTE

A large poster that you can print and put up in your classroom for this section:

¹ bit.ly/1a9QXOn

TAKE NOTE
Concentric objects share the same point as their centre.

The lithosphere is considered the outer layer of the Earth. The Earth is made up of concentric layers called the **crust**, the **mantle** and the **core**.

Imagine that we cut away a slice of the Earth, as shown here:



Inside, we would then be able to see the layers of the Earth, as shown in the next diagram:

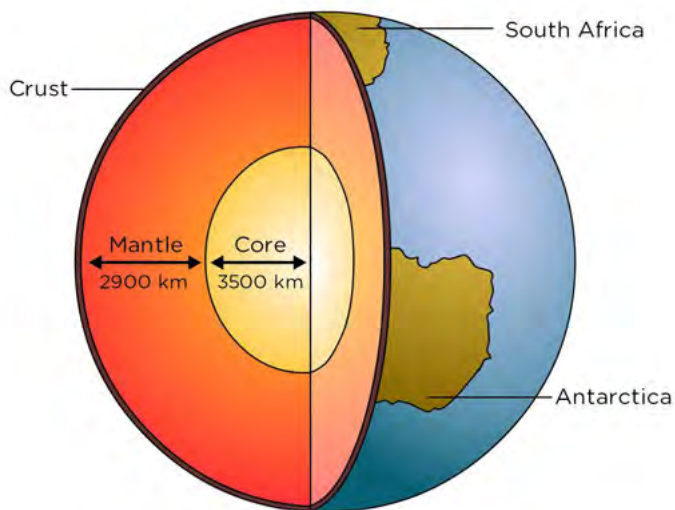

VISIT

Layers of the Earth.
bit.ly/HIXDT7

TEACHER'S NOTE

Learners might have already learnt about this in previous grades in Social Sciences.

The core has two parts, the **inner core** which is solid and the **outer core** which is liquid. The mantle can also be divided into two parts, the **lower mantle** and the **upper mantle**. Some parts of the crust are found under the oceans. This is called the **oceanic crust**. Other parts of the crust form part of the continents and is called **continental crust**.

The brittle upper part of the mantle and the crust form the **lithosphere**. The lithosphere, the mantle and the core are sometimes called the **geosphere**. The geosphere is also one of the parts of the Earth, just like the **hydrosphere**, **atmosphere** and **biosphere** that you learnt about in the previous chapter.

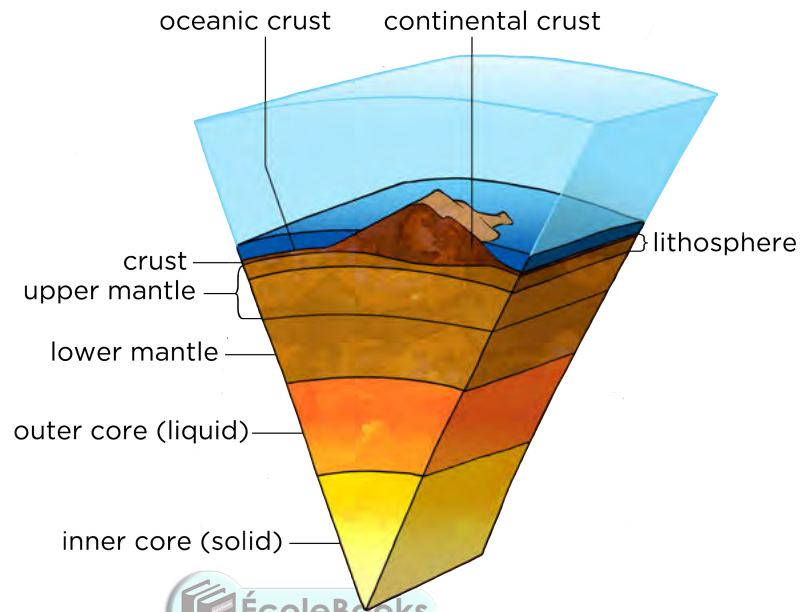

The layers inside the Earth.

VISIT

100 Greatest Discoveries:
The centre of the Earth
(video). bit.ly/1ioEuLI

ACTIVITY: Build a 3D-model of the Earth

TEACHER'S NOTE

This activity can be used as a project which can be completed over the course of the term. For this project learners can work in pairs. They need to build a labelled model of the Earth and do some additional reading to find out more about each of the layers. You can put the models up for display in your classroom and refer to them in further teaching. Coloured paper or painted paper mâché can be used as alternatives to other expensive materials. You can use Assessment Rubric 7 at the back of your Teacher's Guide to assess their models.

How to make paper mâché (video).² bit.ly/Hr23rj



INSTRUCTIONS:

1. Use recycled material and modelling clay to build a three-dimensional model of the inside of the Earth.
2. All the layers of the Earth need to be included and accurately labelled on your model.
3. Write a one page summary on the layers of the Earth. Read about each of the layers to be able to answer the following questions in your write-up. You can use the internet, library books or ask knowledgeable people in your community.
 - a) Thickness of each layer
 - b) State of matter
 - c) Temperature
 - d) Composition (what it is made up of)

ACTIVITY: The layers inside the Earth

TEACHER'S NOTE

The aim of this activity is to provide learners with some structure to make sense of all the new terminology that is introduced in this section. Some of the terms might be familiar, but learners might not have had to link it all up.

This map will be used later in the chapter again. This activity tests learner's ability to comprehend and then translate the information into a visual map. This is quite a simple activity in the sense that the basic structure of the map is provided, but later they will be required to provide their own structure. This is not a concept map, but rather a topic map to show learners how the different terms are related.

The learners have been exposed to various kinds of maps over the past 3 years in Natural Sciences. These are all attempts to support them in developing different ways of organising information to enable them to learn better. The different maps could also help learners develop their own way of summarising information for studying purposes.

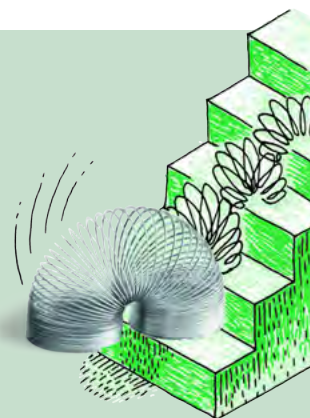

INSTRUCTIONS:

Use all the words in bold in the previous section to complete the following map:

VISIT
How tall can mountains be?
bit.ly/tioEgnP

TEACHER'S NOTE

The completed topic map.

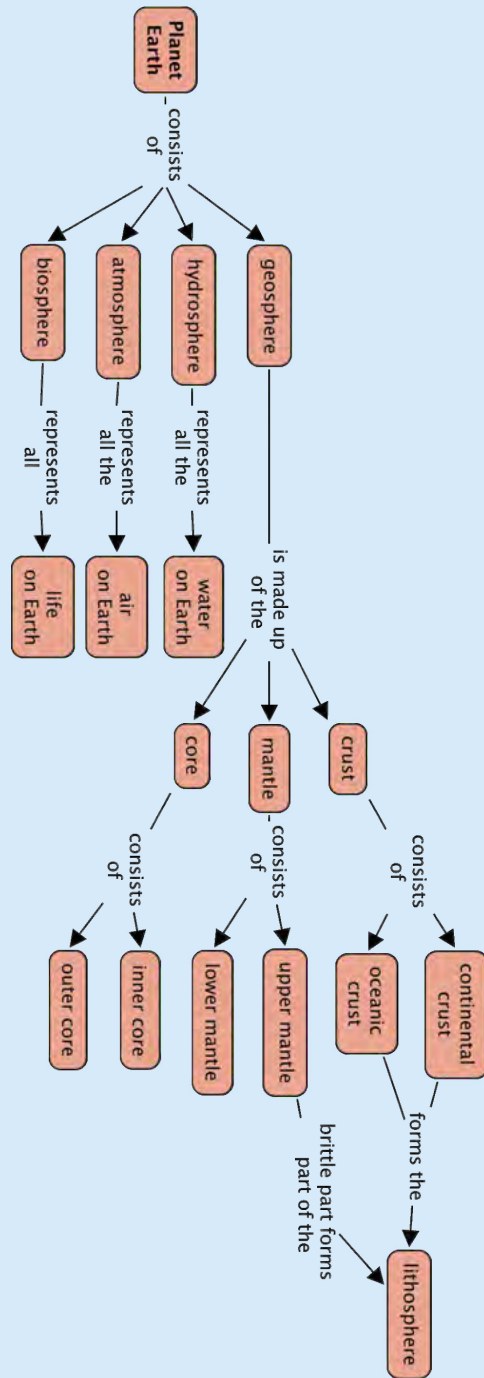

In the first activity of this chapter we collected different rocks. Why are there different types of rocks and why do they look different? These are the questions we will answer in the next section.

2.2 The rock cycle

In previous grades you learnt about the water cycle. A cycle is a combination of processes that take place in a certain sequence and which repeat over and over again from the beginning. Processes in a cycle do not stop and are therefore said to be continuous. For example, the **water cycle** which is part of the biosphere describes how water forms clouds, rain, rivers and clouds again.

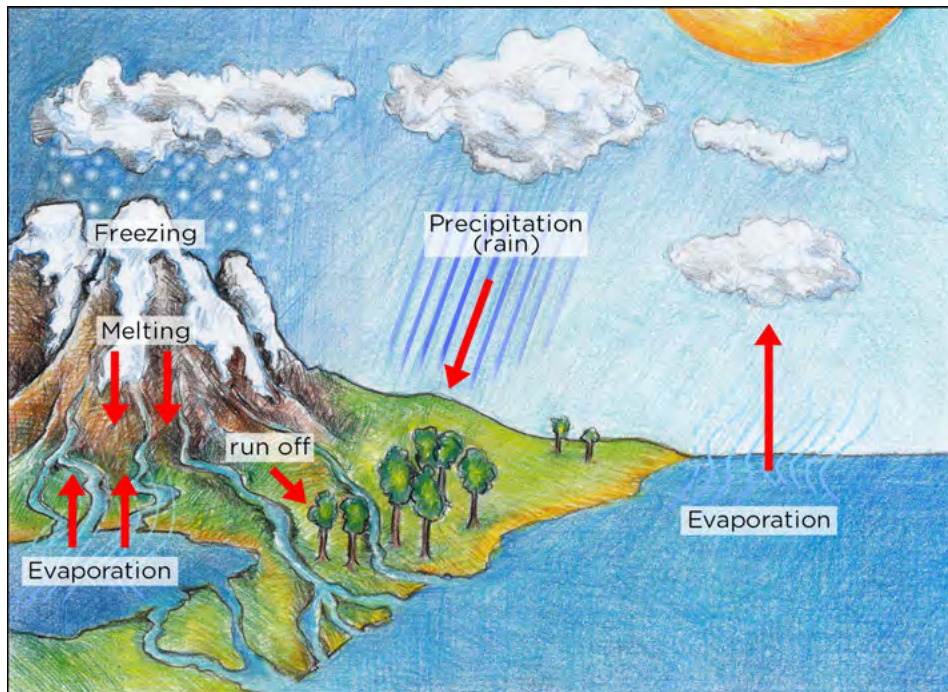

An example of a cycle, with which you are familiar, is the water cycle.

The **carbon cycle**, which takes place as part of the biosphere, describes the movement of carbon through carbon dioxide, fossil fuels and carbohydrates. The **rock cycle** is part of the lithosphere and it describes how rocks change from one form into another and eventually back into the first form.

How does the rock cycle work?

Rocks on Earth are divided into three broad categories:

1. **sedimentary rocks**
2. **metamorphic rock**
3. **igneous rock**

This classification is based on where the rocks were formed. The following diagram summarizes the rock cycle.

VISIT

The 3 types of rocks.
bit.ly/19MJOGT

TAKE NOTE

Not all rock on Earth is recycled. Thousands of tons of rock fall to Earth from space every year.

VISIT

The rock cycle (video).
bit.ly/1cms6hS

Interactive animation to show you how the rock cycle works. bit.ly/18upID6

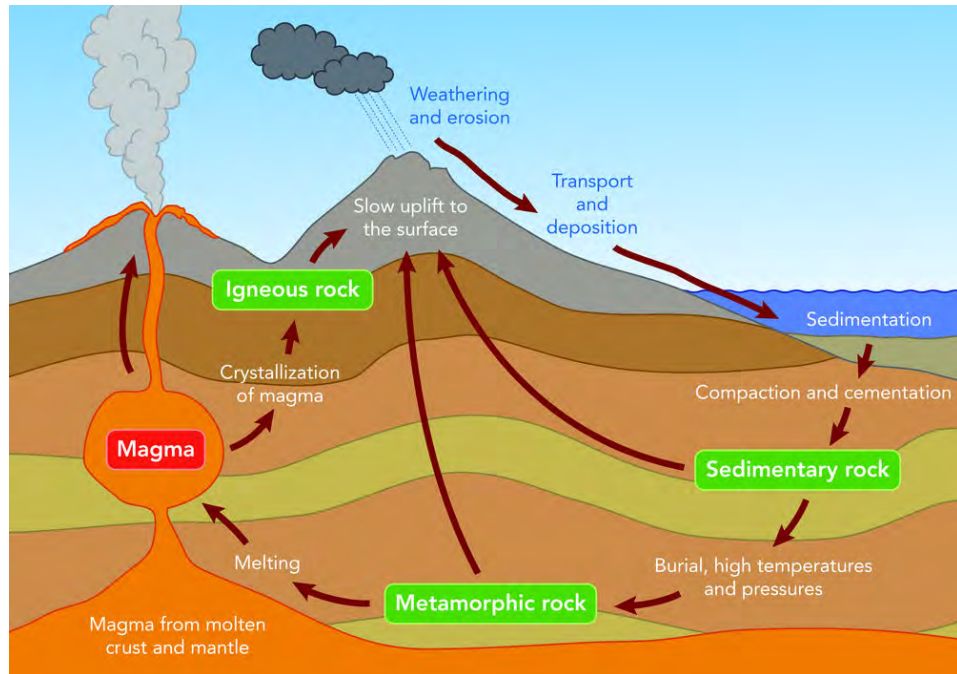

TAKE NOTE

Heat causes expansion of rocks and cold causes contraction.

The rock cycle is a natural continuous process in which rocks form, are broken down and re-form again over long periods of time. The process can be described as follows:

- Wind, water, heat and cold cause the weathering of rocks on the surface of the Earth. The rocks are broken up into smaller and smaller pieces and form sand.
- Wind and water wash the sand and small stones away and deposit them as **sediments** into lakes and the ocean. This process is called **deposition**.
- The sediments settle at the bottom of the oceans, lakes and rivers. Over time they get covered with more layers of sediment. The pressure from the additional layers causes the sediments to compact and solidify to form **sedimentary rock**.
- The sedimentary rock may be buried deeper and deeper beneath the surface of the Earth through movement in the Earth's crust (where oceanic plates and continental plates meet). The rocks can also be pushed deeper (subducted) into the Earth. As the rocks move deeper into the Earth, temperature and pressure increase.
- Rocks become more compact as processes of compaction and cementation occur. As the chemical compounds in the rocks change, due to heat and pressure, metamorphic rock is formed.
- Over time the metamorphic rock can move deeper into the Earth, melt and become **magma**.
- Magma moves towards the surface of the Earth through volcanic pipes. The hot magma cools slowly on its way to the surface and forms **igneous rock**. Magma can also break through the surface as lava in volcanoes. In this case, the lava will solidify quickly on the surface to form igneous rocks. Igneous rock can form in the crust or on the surface.
- Igneous rocks get eroded by wind and water and the whole process starts again.

Metamorphic rock is formed deeper under the surface and only becomes exposed to the surface when the layers above it are removed by erosion.

Igneous rock, just like sedimentary rock, can move deeper into the Earth and form metamorphic rock due to the increase in pressure and temperatures.

As you can see in the previous diagram, rocks of all types may move down through the mantle, melt and mix with magma. The Earth's crust is continually recycled. This is why we refer to the process as the **rock cycle**.

ACTIVITY: Summarising the rock cycle

QUESTIONS:

1. Complete the diagram by filling in which type of rock belongs where:
Sedimentary rock, Metamorphic rock, Igneous rock.

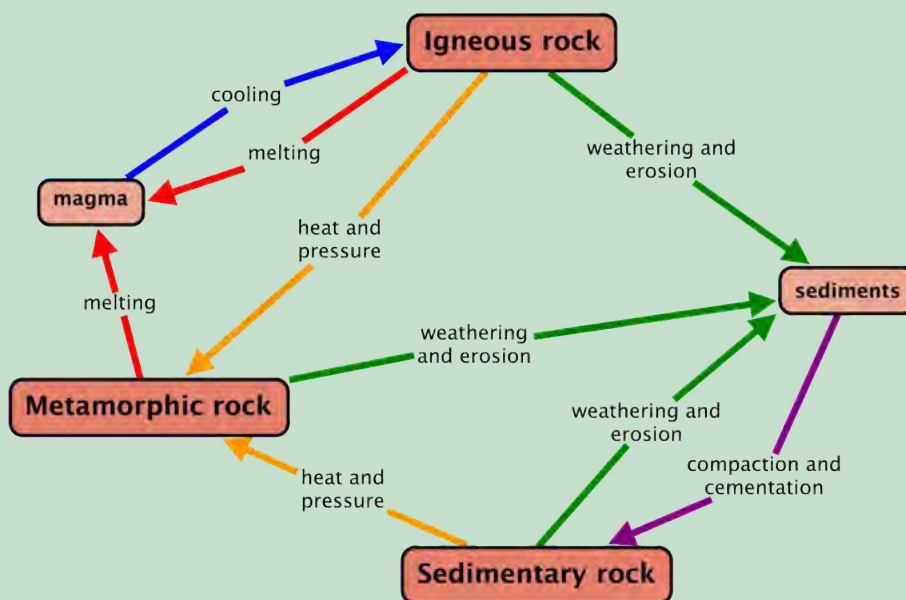

2. Name the process by which igneous rock is formed.
Cooling.
3. Which type(s) of rock form sediment?
Igneous, metamorphic as well as sedimentary (all rock types).
4. What conditions are needed for metamorphic rock to form?
Increased temperature and pressure.
5. Explain what 'weathering and erosion' of rock mean.
It is the action of wind and water which cracks and breaks up pieces of rock.
6. Explain what 'compaction' means.
It is a process where the particles are compressed closer together (for example through the action of pressure).
7. What type of rock is formed through compaction?
Sedimentary rock.
8. What is magma? Explain the role of magma in the rock cycle.
Magma is molten (melted) rock. It is called lava when it flows onto the surface of the Earth. Magma and lava form igneous rock when they cool, either above or below the Earth's surface.

TAKE NOTE

Magma and lava are both molten rock, but refer to different locations. Magma is molten rock that forms beneath the Earth's surface. When magma erupts out of a volcano onto the surface, it is referred to as lava.



ACTIVITY: Explaining the rock cycle

TEACHER'S NOTE

This is an alternative activity to the preceding one. It can be used instead of the previous one, or if you feel that your learners need more practice in writing about what they have learnt, then this is an ideal homework exercise. It could also be used as a quick class test, to check for understanding. Learners can assess their own writing, or swap with a friend.

INSTRUCTIONS:

Write a paragraph to explain the rock cycle in your own words. Start the explanation with the formation of igneous rock. Use full sentences and include the following key words in your write-up.

VISIT

A useful website which shows all the different rock types and classifications.

bit.ly/17nxyiC

Key words:

- melting
- deposition
- erosion
- cooling
- compact
- temperature
- pressure
- metamorphic rock
- igneous rock
- sedimentary rock

The words can be used more than once, and you should add your own keywords as well. You should also include a labelled diagram in your write-up.

TEACHER'S NOTE

Learner-dependent answer. Ensure that learners use the terms correctly and that the process is explained accurately. Learners should NOT copy the text from the workbook, but should write this in their own words.

The diagram on the rock cycle can be used as a guide as to what their labelled diagrams should look like.

Use the following as a guide for the answer:

The rock cycle is the natural, continuous process in which rocks form, are broken down and re-form over long periods of time. There are three rock types: igneous, sedimentary and metamorphic rocks. The rock cycle can be explained in the following steps:

TEACHER'S NOTE

- molten rock from the mantle (magma) pushes up through the crust
- pools of magma cool down slowly in the crust to form igneous rocks, like granite
- some magma escapes to the surface as lava in the form of a volcano
- lava cools to form igneous rocks
- the rate at which the lava cools affects the properties of the rocks formed
- rocks on the surface of the Earth are weathered by heat (expansion), cold (contraction), wind and water to form smaller particles
- wind and water transport these particles to floodplains and the sea by erosion
- the particles are laid down as sediments
- the sediments are covered by more layers of sediment
- the pressure of many layers turns the lower layers into sedimentary rock like sandstone
- magma heats the surrounding rock and changes its chemical structure to form metamorphic rock like slate from shale or marble from limestone
- some rock is pushed below the crust, melts and becomes magma again

We are now going to take a closer look at each of the three main types of rocks.

Sedimentary rock



TEACHER'S NOTE

Learners do not need to memorise the different names for all the examples of rocks in the following three sections, but they should be able to name one or two examples for each rock type. It is important to realise that rocks are used as materials in our daily lives. Many of the words will be familiar as they are referred to in everyday language (limestone, granite, etc.) so it will be good for learners to know the origins of these stones. This section links up with what is covered in the Matter and Materials strand. Stone is a natural material and resource that humans have used in the past and are still using today. The usefulness of a particular material, stone in this case, is due to its properties.

Sedimentary rocks are formed when layers of sediment solidify over time. Sediments are layers of particles from pre-existing rock or once-living organisms, for example, shells. Rocks on the surface of the Earth are weathered by expansion and contraction due to changes in temperature, wind and water, and also by erosion due to animals. Bigger rocks break up into smaller and smaller particles through the process of erosion.

VISIT

Rocks erode to form soil.
bit.ly/1ak9R1b



Changes in temperature cause rocks to crack and break up. Plants may grow in the cracks, causing them to break up further.



Rain wears down rocks and causes smaller pieces to break off.

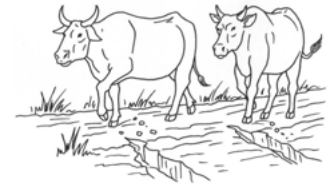

Animals break up rocks into smaller particles as they walk along.

Wind and water transport the loose, smaller particles, along with debris from living organisms, and some large stones, eventually depositing them on flood plains and in the sea. This is called erosion.

The material accumulates at the bottom of oceans, rivers, lakes and swamps. The sediment settles and forms layers. These layers build up upon each other and cause the compaction of the lower layers.



Soil erosion due to water.³

Over time, the bottom layers eventually solidify and form layers of sedimentary rock, as is shown in the following diagram.

VISIT

Formation of sedimentary rock under the sea.
bit.ly/1at0i4l

TEACHER'S NOTE

An easy demonstration to show the concept of deposition is to mix some soil in water in a glass jar and then place it on the table in front of the class and allow the particles to settle at the bottom through the course of the class. You can then also pour in different colours of sand or soil to illustrate the different sedimentary layers.

TEACHER'S NOTE

The video link provided in the **Visit** box on the 'Formation of sedimentary rock under the sea' provides a clear and easy to understand demonstration of how sediment is deposited on the bottom of the sea in layers. You can even construct something similar to this model in your classroom to show learners.

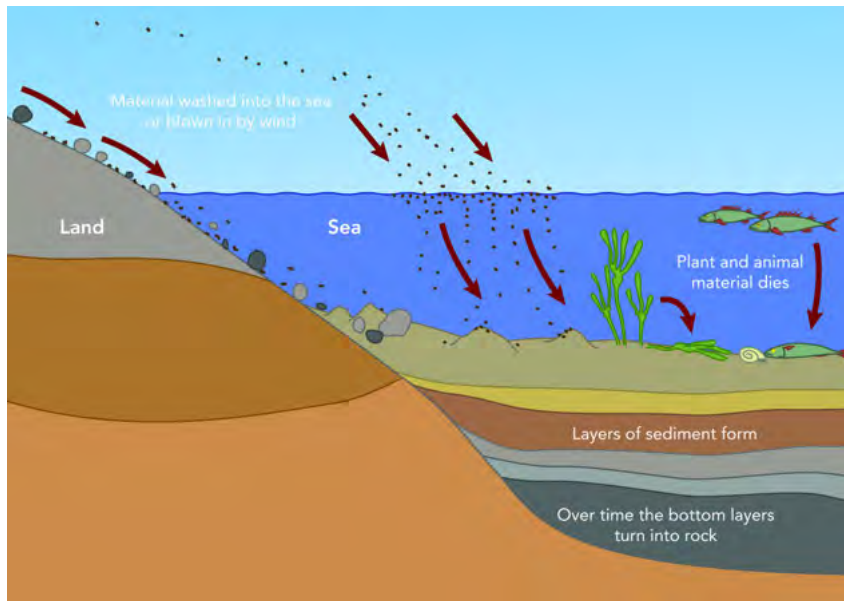

The formation of sedimentary rock.

Although sedimentary rock is found in most places on Earth, these rocks make up only 8% of the Earth's crust. Different layers of sedimentary rock may be seen in the mountains and rocks around us on a daily basis.

In the photograph you can clearly see the layers of sediment which have solidified over millions of years to form the sedimentary rocks of the Grand Canyon.



The layers in the sedimentary rock in the Grand Canyon.

You can see the layers in the sedimentary rock making up Table Mountain in Cape Town.

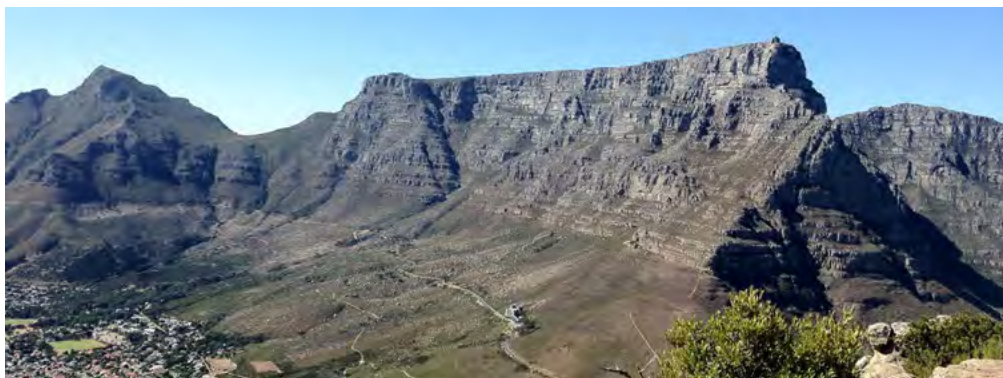

The sandstone layers of Table Mountain.

There are different types of sedimentary rock, including sandstone, limestone, dolomite, coal, shale and conglomerate.



Sandstone rock in the Cederberg in the Western Cape.



Layers of limestone sedimentary rock.

Limestone is a sedimentary rock made from the mineral calcium carbonate (CaCO_3), often formed from the remains of the skeletons of marine animals. We use limestone as building stone in the manufacture of lime (calcium carbonate), and cement.

Dolomite is a sedimentary rock made from calcium magnesium carbonate ($\text{CaMg}(\text{CO}_3)_2$). Coal is another example of sedimentary rock formed from the solidified remains of ancient plants at the bottom of swamps.

Shale is a very fine-grained sedimentary rock formed from the deposition of mud and silt. It is made up of very thin layers all stuck together. Conglomerate is a sedimentary rock made up of small stones, shells and other pieces of sediment.

Cementation is the process whereby sand and associated shells, pebbles and other sediment become cemented together to form sedimentary rock.

Sedimentary rock is softer than the other types of rock. It is eroded by the actions of wind, water or ice (glaciers). Fossils, especially of sea creatures, are often found in sedimentary rocks, lying cemented in the sediments in which they fell when they died. When plants or animals die, they are often covered in sand, which later becomes rock, capturing the fossil inside.



Dolomite mountains.



Fossils in sedimentary rock.



Limestone (creamy-brown) on top of shale (dark grey).



Conglomerate showing the layers with small pebbles embedded in the rock.

Let's take a look at how the layers of sediment are compressed and become harder over time due to pressure.

ACTIVITY: Modelling the formation of sedimentary rock

TEACHER'S NOTE

This activity can be done as a classroom demonstration. Pile books on top of a few slices of bread until they cannot be compressed further. Let the learners make observations and draw what they observe. Also show them the layers afterwards - the different layers are not distinguishable any more, they merge into one mass.

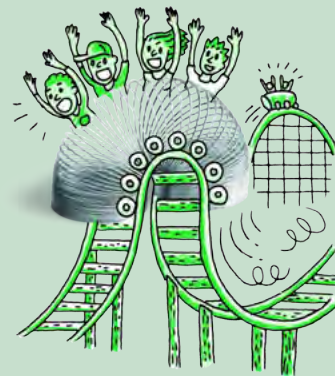

MATERIALS:

- 3 slices of white bread
- 3 slices of brown bread
- heavy books or object

INSTRUCTIONS:

1. Cut off the crust from all the sides.
2. Layer the slices on top of each other, alternating the white and brown slices. Each slice represents a different layer of sediment.
3. Draw a labelled diagram of what the stack looks like.
4. Place a piece of plastic on top of the bread stack to protect the bottom book in your bookstack, then place a pile of books on top of the bread stack. Observe what happens to the layers. Write your observations here.



5. Add more books to the pile and observe. What happens to the layers?



6. Remove the books from the bread pile. Can you distinguish the different layers now?



7. Draw a labelled diagram of the bread layer.
8. Explain how this model demonstrates the formation of sedimentary rock.

TEACHER'S NOTE

This is a good opportunity to discuss how models are used in Science to represent and explain what happens in reality. This model shows how different layers of sediment are deposited, represented by the different layers of brown and white bread. Initially the layers are quite loose, but over time as more layers are added, the bottom layers become compressed. This is represented in the model by adding on more books to increase the pressure on the layers. More books are added to represent the passing of time and more pressure. Eventually the layers of rock are squashed (cementation has taken place) and it is not as easy to recognise the different layers, as in sedimentary rock.

Metamorphic rock

TEACHER'S NOTE

A suggestion is to get samples of slate, marble, sandstone and granite from natural stone tile shops for learners to look at and handle.

Metamorphic rock makes up a large part of the Earth's crust. Metamorphic rocks are formed when sedimentary or igneous rocks are exposed to heat and pressure. Metamorphic rocks do not form on the surface of the Earth, but rather deeper underneath the surface where the temperatures and pressures are much higher. When other types of rock experience higher pressures and temperatures the rock crystals are squashed together. They undergo changes in crystal structure to form metamorphic rock.

Metamorphic rock may move deeper into the Earth where they melt, forming magma. The magma may then cool and form igneous rock.

Some examples of metamorphic rocks are slate, marble, soapstone, and quartzite.

Slate is a metamorphic rock that was formed by shale (sedimentary rock) that was metamorphosed. Slate is often used for roofing or flooring. Since it can be cut into shapes and does not absorb moisture, it makes a good material for tiles.



Roof tiles made from slate, which was formed from shale (a sedimentary rock).

Marble is a metamorphic rock that is produced from the metamorphosis of limestone. It is used for countertops, flooring and tombstones and is a very durable building material.

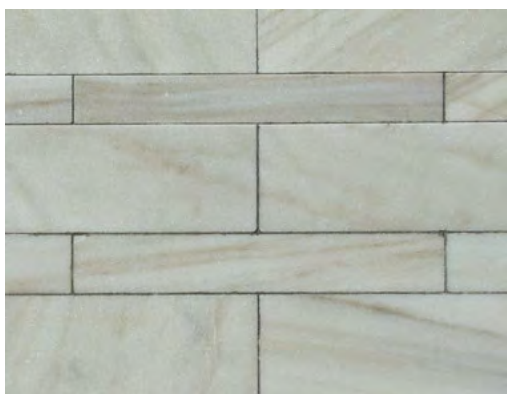

Marble blocks in a wall.



A marble arch in London.



Soapstone is a relatively soft metamorphic rock. It is often used as an alternative natural stone countertop instead of granite or marble, for example in kitchens and laboratories. In laboratories it is unaffected by acids and alkalis. In kitchens it is not stained or altered by tomatoes, wine, vinegar, grape juice and other common food items. Soapstone is unaffected by heat. That means that hotpots can be placed directly on it without fear of melting, burning or other damage. Many statues and carvings are also made from soapstone.



Soapstone carvings.



A pot made from soapstone.

Quartzite is formed through the actions of heat and temperature on sandstone. If you compare the texture of sandstone with quartzite in the pictures shown here, you will see that the process of metamorphism changes the texture from sandy to more glossy.

The crystals in the quartzite are bigger and the layers have disappeared. Quartzite is much harder than sandstone.



Sandstone.



Quartzite.

TAKE NOTE

Molten refers to liquids which are extremely hot, and whose usual form is a solid (e.g. rock). However, something **melted** need not be hot, nor a complete liquid (e.g. butter).

Igneous rock

Igneous rock is formed when magma cools down. Three factors play a role when igneous rocks are formed:

1. **Where it is formed:** The rocks are formed on the surface they are called **intrusive** rocks. If they are formed under the surface they are called **extrusive** rocks.
2. **How quickly it cools:** When magma cools quickly, small crystals are formed and the resulting rock has a fine-grained texture. When it cools slowly, larger crystals form, resulting in a more coarse-grained rock. Sometimes the individual crystals can be seen with the naked eye.
3. **How much gas is trapped:** Magma contains molten rock and lots of gas. The gas is under pressure deep in the Earth. When the magma breaks through the surface, the gas is released. Depending on how quickly the magma cools down, the gas has more or less time to escape. When the magma cools down very quickly, lots of gas is trapped resulting in cavities and openings forming in the rock.

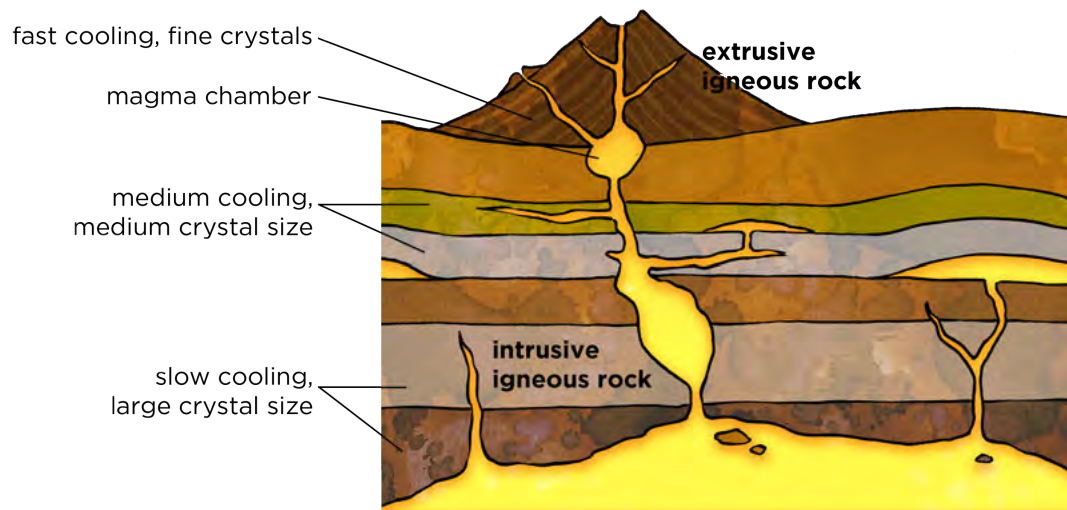

VISIT

How volcanoes are formed.
bit.ly/1eZqDf2
 A volcano expedition.
bit.ly/1hmlSDa

A volcano is an opening or rupture in the surface of the Earth's crust (or another planet) which allows hot lava and volcanic ash to escape in an eruption from the magma chamber below.



The Cleveland Volcano eruption in 2006 in Alaska, photographed from the International Space Station.



An eruption from Mount Etna in Italy in 2007.

VISIT

Pompeii (full documentary).

bit.ly/HbQULb

Examples of igneous rock are basalt, granite and pumice.

Basalt is the most common igneous rock and makes up a large part of the rocks just under the surface of the Earth. Most of the oceanic crust is basalt rock. It is a dark-coloured rock and is used as building material, particularly in building stone walls.

Basalt is not only found on Earth, but also on the Moon and Mars! The highest mountain on Mars, and also the biggest, known volcano in our solar system - Olympus Mons - was formed from basaltic lava flows.



Basalt.



Olympus Mons, a volcano on Mars.

VISIT

Mars' largest volcano.

bit.ly/IioFEn

Granite is an igneous rock with large grains. It was formed from magma which slowly crystallised below the surface of the Earth. Granite is one of the most well-known types of rock. It is used to make numerous objects such as tabletops, floor tiles and paving stone.



Various colours and patterns of granite rock.

Pumice rock is an example of extrusive igneous rock. It is formed from the lava emitted during volcanic explosions. Because the lava cools down very quickly, a lot of gas is trapped in the rock. As a result, pumice is a very porous rock, with lots of holes in it, making it the only rock that can float on water. Pumice stones are used in lightweight concrete and as an abrasive in industries and in homes.



Pumice stone used as an exfoliator.

TEACHER'S NOTE

Pumice rock is formed when volcanoes explode. A lot of gas is trapped in magma. The gas is under pressure when the magma is under the surface. When it breaks through the surface the pressure is released in a very short period of time. The suddenly exploding gas is forced up and out of the volcano, taking along all the molten rock around it. This is observed as an explosion of gas and molten rock that can be thrown kilometres away from the volcano. The magma cools very rapidly and can form rocks ranging from small pebbles to rocks the size of a house.

This process can very effectively (and dramatically) be demonstrated by using fizzy drinks. Fizzy drinks have gas dissolved under pressure. When the cap of a fizzy drink bottle is opened, the gas can escape very quickly. If the bottle is shaken before opening it, the effect of a volcanic explosion can be shown. This can be a very messy demonstration that should be done outside.

Once the demonstration is done, the analogy explaining the formation of pumice rock should be consolidated in class. Learners should note that the liquid is shot up and out of the bottle. They need to imagine that it is hot lava with gas dissolved in it. When the magma breaks through the crust, it explodes with a lot of force. The lava is shot up high into the air and will cool down very quickly to form rocks. Rocks are strewn over a very large area around the volcano.

WARNING: This demonstration should be done outside and learners should stay clear of the area.

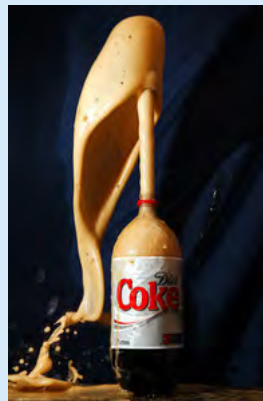

ACTIVITY: Comparing the properties of igneous rocks

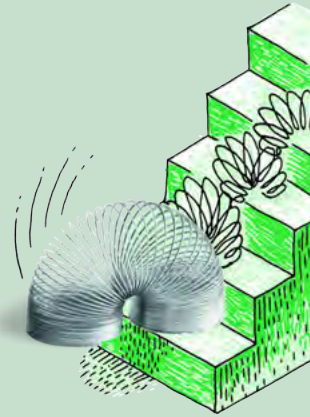

TEACHER'S NOTE

This is an optional activity.

INSTRUCTIONS:

Study the following igneous rocks and compare their similarities and differences in the following table.



Sample 1.



Sample 2.



Sample 3.



Sample 4.

TEACHER'S NOTE

Sample 1 is basalt, sample 2 is obsidian, sample 3 is granite and sample 4 is pumice.

TEACHER'S NOTE

Sample	Where was the sample formed? Extrusively or intrusively	How quickly did it cool? What evidence do you have for your answer?	Was air trapped when it was formed? What evidence do you have for your answer?	Describe the colour
Sample 1	Extrusively	Very fine crystals	No, no visible holes	Dark, green-grey
Sample 2	Extrusively	Fast, no visible crystals	No, no visible holes	Shiny black
Sample 3	Intrusively	Slowly, there are large interlocking crystals	No, no visible holes	Mottled with yellow-brown, white and black
Sample 4	Extrusively	Fast, there are no crystals	Yes, there are holes in the rock where gas bubbles were trapped	Grey-black

VISIT
Resource to use for the project on classifying rocks.
bit.ly/16gyySK
Identifying types of rocks.
bit.ly/17TqDYJ



ACTIVITY: Classifying rocks

TEACHER'S NOTE

This can be used as an optional, extension project.

INSTRUCTIONS:

1. In this project you will be working in pairs. You need to collect rocks from your neighbourhood, or borrow some rocks from someone's rock collection.
2. You will need at least 12 different samples of rock.
3. Try to find as much variety as possible, applying what you now know about the three different rock types.
4. You could also ask a geologist to provide you with a variety of rock samples to identify.
5. Go to the website provided in the **Visit** margin box and follow the flow diagram to identify all your rock samples.
6. You need to create a display of the rocks and how you have identified them using the flow diagram and their properties.



Rocks contain minerals

TEACHER'S NOTE

CAPS places this section directly after discussing the core, mantle and crust. We have moved it to the end of the chapter so that learners have a bit more knowledge about the different rock types. Placing it here also prepare learners for the next chapter on mining these minerals.

We started this chapter by collecting rocks and looking closely at their characteristics. We then looked at how rocks were formed. The question now is why do we need to know about rocks and why are rocks important. Let's look at what makes rocks so valuable.

Rocks contain **minerals**. A mineral is a chemical compound which occurs naturally, for example, in rocks. There are several thousand types of minerals which are found in different combinations in rocks. They consist of metal and non-metal atoms combined in various ratios.

Let's look at some examples. Copper is a valuable metal because it is a good conductor. It is used in electrical cabling and other electrical applications. There are about 15 different types of rock which contain copper compounds. One such compound is copper(I)sulfide or Cu_2S . When this compound is found in rocks it is called a mineral named chalcocite. Copper can also be found as the compound CuFeS_2 or chalcopyrite.

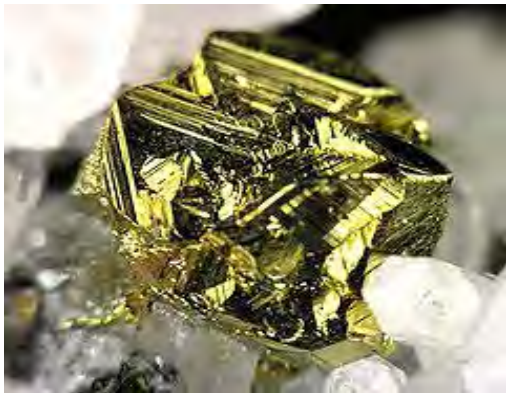

Chalcopyrite crystals.



Chalcopyrite ore.



Chalcocite crystals.



Chalcocite ore.

VISIT

A brief introduction to minerals. bit.ly/1ioFFLd

The minerals chalcocite and chalcopyrite can be found in many different types of sedimentary, metamorphic or igneous rocks. If we would like to use the copper from these rocks, we need to find a way to get it out of the rock and into the metal form. This we will discuss in the next chapter.

Quartz and feldspar are the two most abundant minerals in the crust. Quartz is the mineral form of silicon dioxide (SiO_2). Potassium feldspar has the formula KAlSi_3O_8 . A rock may be composed almost entirely of one mineral or could be made of a combination of different minerals. Different combinations of different minerals in rock will result in a different types of rock.



ACTIVITY: What minerals are found on Earth?

TEACHER'S NOTE

This can be used as a research project. It can be presented as a written report. A useful resource giving the relevant information for this activity can be found here: ⁴ rsc.li/17rVgrL

This link also includes a very useful worksheet that can be used as an end of section exercise.

INSTRUCTIONS:

In this chapter you have learnt about the Earth's crust and minerals that occur in rocks. Read more about the Earth's crust and answer the following questions:

1. What are the most abundant elements in the Earth's crust?
2. Why are these elements so abundant?
3. How did the elements get into the Earth's crust?
4. Why are the elements important?
5. What do you think are the most important element(s) in the Earth's crust?
Give a reason for your answer.



SUMMARY:

Key Concepts

- The Earth consists of four concentric layers called the inner core, the outer core, the mantle and the crust.
- The lithosphere consists of the solid outermost part of the mantle, the crust and sediments covering it.
- The rock cycle is the natural continuous process in which rocks form, are broken down and re-form over long periods of time. The rock cycle has a number of steps.
- There are three rock types: igneous rock, sedimentary rock and metamorphic rock.
- Sedimentary rock is formed when rocks on the surface are weathered and the small particles, along with plant and animal material, are deposited in sediments at the bottom of lakes, oceans and rivers. Over time, more and more layers of sediment are deposited. The resulting increase in pressure causes compaction and the formation of hard layers of sedimentary rock.
- Fossils are often found in sedimentary rock as when some organisms die, they become incorporated into the layers of sediment..
- Hot magma is found deep below the surface of the Earth. When magma cools slowly, below the surface of the Earth, it forms intrusive igneous rock. When the magma pushes up through the crust (for example in a volcano), it cools rapidly and forms extrusive igneous rock.
- Hot magma can heat the surrounding rock and change other types of rock into metamorphic rock.
- Different combinations of elements and compounds form the minerals in the crust.

Concept Map

Use the concept map on the next page to summarise what you learned about the lithosphere and rock cycle in this chapter. If you want to add more links or information into the concept map, you should do so.

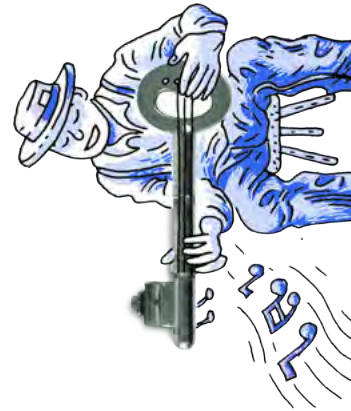

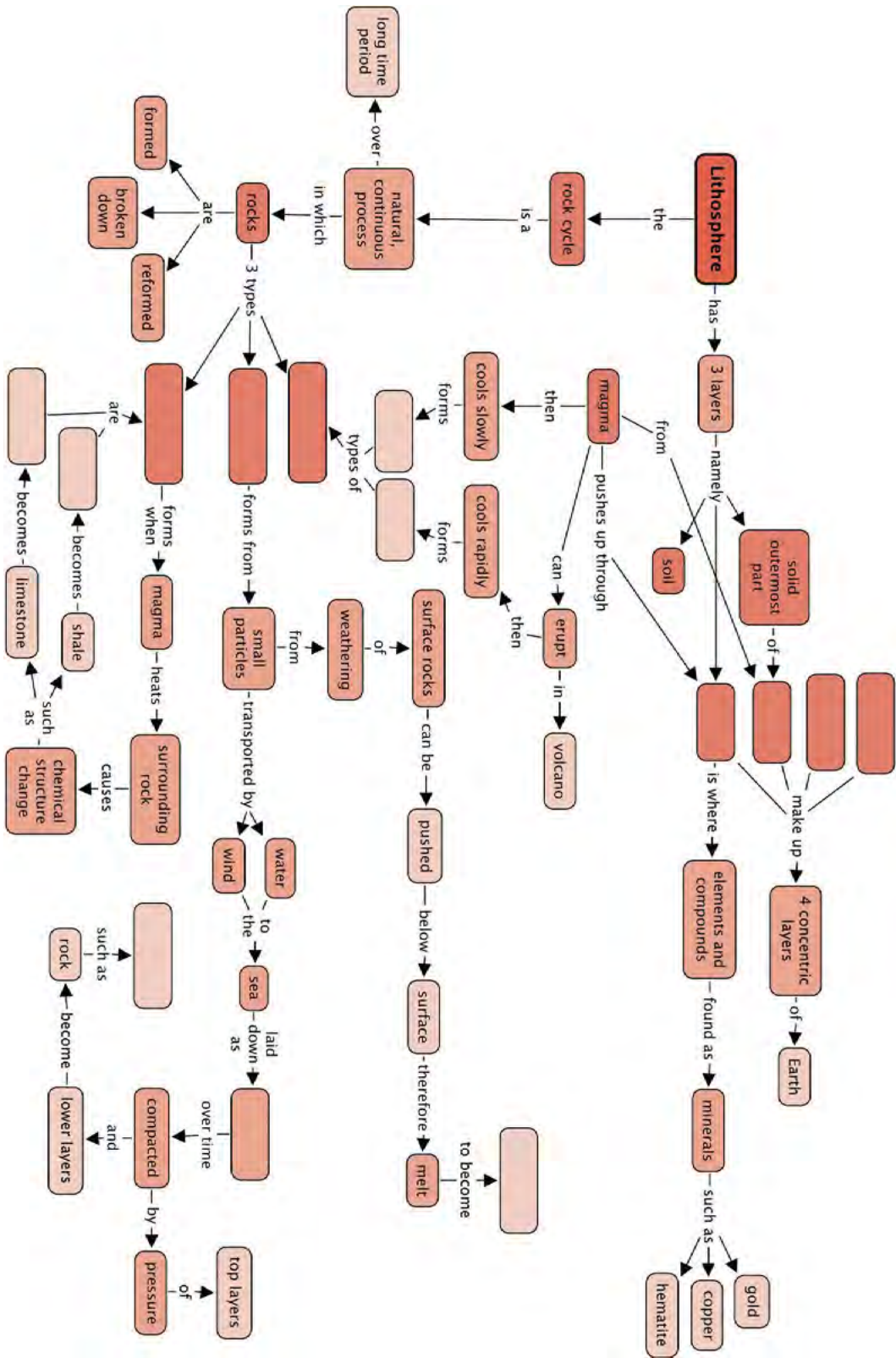

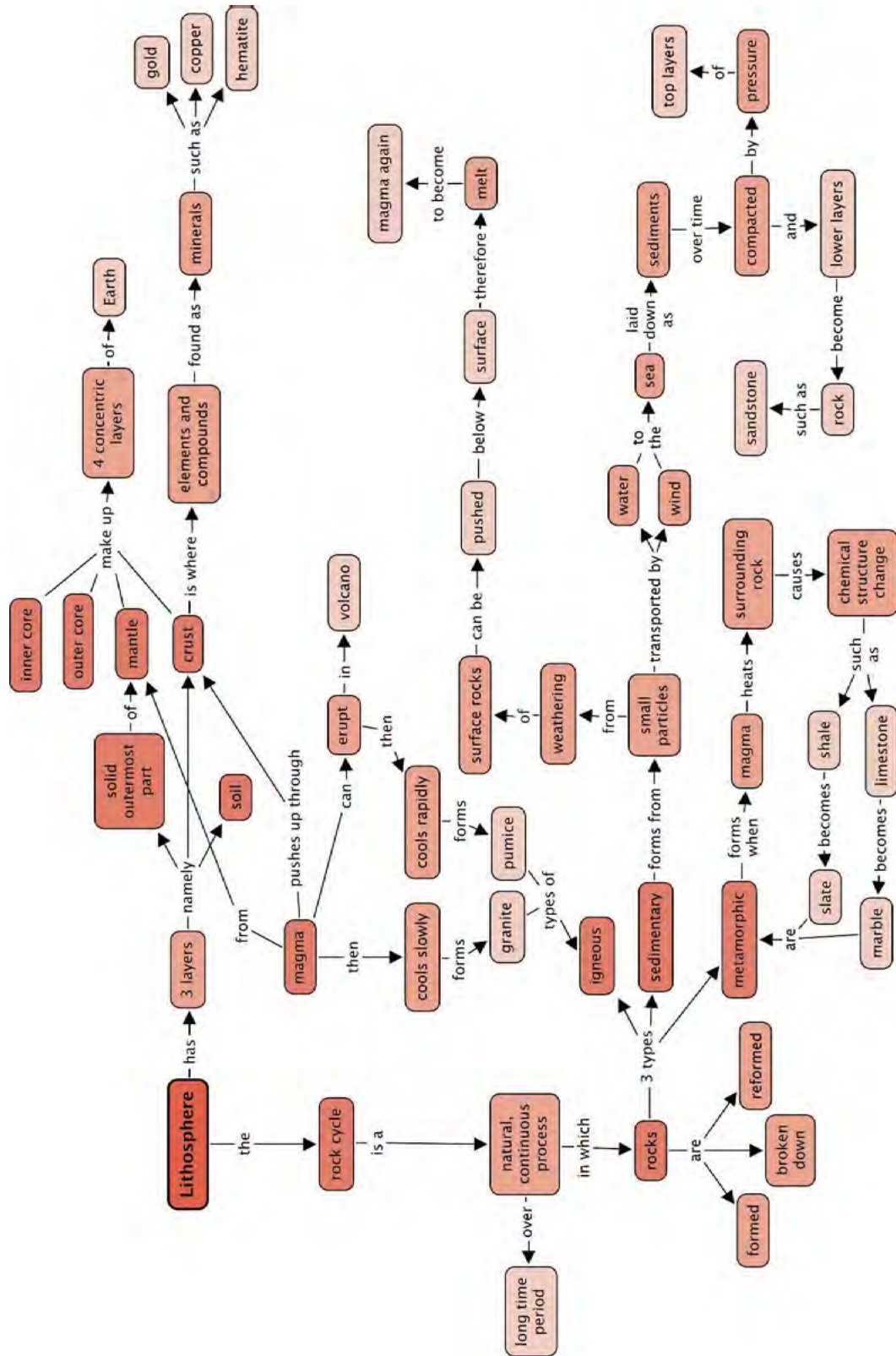

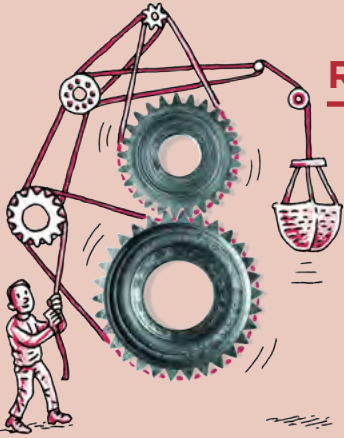

REVISION:

1. The Earth consists of different layers.
 - a) Label the following diagram: [4 marks]
 - b) What is the difference between parts C and D? [2 marks]
 - c) What does part B consist of? [1 mark]
 - d) Give three examples of things found around your school that form part of part A. [3 marks]

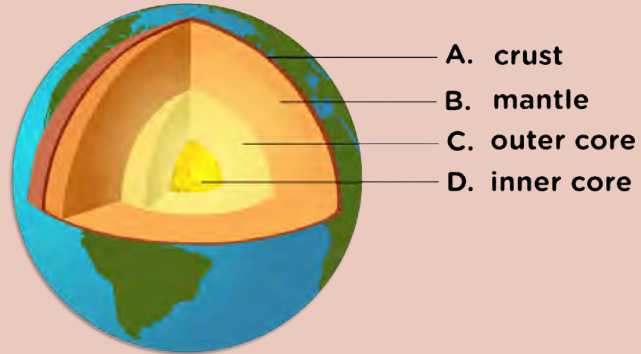

- a)
 - b) *C (the outer core) is liquid and D (the inner core) is solid.*
 - c) *Magma or molten rock.*
 - d) *sand, stone, rocks, pebbles, clay (any three).*
2. Why are there so many different rocks found on Earth? [2 marks]
Rocks are formed through many different processes resulting in a large variety of different combinations of rock minerals.
3. The diagram below shows the formation of one of the rock types. Study the diagram and answer the question that follow.

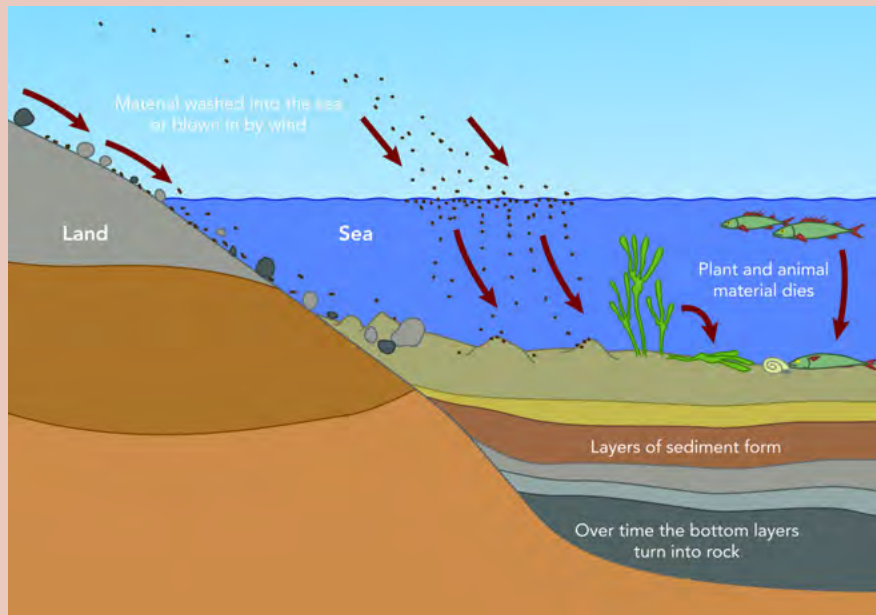

- a) What type of rock formation is shown in the diagram? Give a reason for your answer. [2 marks]
- b) What processes are involved in the formation of this type of rock? [2 marks]

- c) What will happen if the rocks formed here move deeper into the Earth? [3 marks]
- a) *Sedimentary rock. The layers of sediment can be seen forming at the bottom of the ocean.*
- b) *Sedimentation and cementation.*
- c) *The rocks will become hotter and more pressure will be applied. The rocks will become more compact and the chemical compounds in the rocks will change. Metamorphic rock will form.*
4. Fossils are often found in sedimentary rocks. Explain why this is the case. [4 marks]
- When animals or plants die, their remains often end up on the ground and are covered by sand over time. The sand gets compacted and eventually becomes sedimentary rock, with the fossilised remains of the plant or animal still inside the rock.*
5. Explain the difference between the formation of igneous rock, such as granite, and igneous rock, such as pumice. [4 marks]
- Granite is intrusive igneous rock. It forms as magma beneath the surface of the Earth, cools slowly and forms large crystals. Pumice is extrusive igneous rock which forms when magma pushes out of the crust to the surface of the Earth and cools very quickly, trapping bubbles of gas.*
6. Iron is an element found abundantly on Earth, especially in the core of the Earth. Iron combines with oxygen to form haematite, the mineral form of iron (III) oxide. Haematite is present in sedimentary rocks, for example in the Sishen area in the Northern Cape.
- a) What is the formula for iron (III) oxide? [1 mark]
- b) How does iron end up in sedimentary rock? [3 marks]
- c) Why is hematite an important mineral? [1 mark]
- a) *(Fe₂O₃)*
- b) *Sedimentary hematite crystals formed as evaporating oceans left deposits of iron in the sedimentary layers. The iron then combined with oxygen molecules created by the process of photosynthesis. Also accept an answer where learners explain part of the rock cycle, from magma to sedimentary rock.*
- c) *Iron is used to make steel, stainless steel, cars [any appropriate application]*

Total [32 marks]



TEACHER'S NOTE

Chapter overview

2 weeks

In this chapter we build on what was done in the previous two chapters. After learning that rocks contain minerals, we now explore how the minerals may be extracted so that they may be utilised. Mining plays an important role in the wealth of a country. Learners will therefore learn about the mining industry in South Africa and the impact that mining may have on a country and the globe.

The mining industry is an important industry in South Africa. It involves a number of industries working together. Exploration is followed by excavation, which is followed by crushing and milling to reduce the size of the rocks. This is followed by extraction (removing the valuable minerals from the ore) and finally refining. Each of these processes are discussed in this chapter. The idea is not that learners should know all the terms off by heart, but rather that they grasp the bigger picture. A number of different processes are needed with each one dependent on the efficiency of the step before. The flow diagram exercise towards the end of the chapter is meant to consolidate the chapter content and help learners realise the continuous nature of many industrial processes.

A research project is also included in this chapter. Let the learners choose one industry and research the different aspects of mining covered in this chapter for their chosen industry. The following mining industries can be researched: gold, iron, copper, diamond, phosphate, coal, manganese, chromium or platinum group metals (PGMs). Learners could also choose their own.

The projects need to be handed out in the beginning of the term/chapter. Learners can then present their projects at the end of the chapter, by doing a poster or an oral, or both. For the orals, we suggest you work with the language department so that learners can be assessed there as well. If posters are done, then we suggest you put these up for display for the whole school to see. Learners can stand at their posters during breaks where learners from other grades have the opportunity to come and have a look at their work and ask questions about it.

The project has a two-way purpose, firstly for learners to continue learning about doing research, finding information and presenting the information to others, and secondly, for learners to explore careers in this industry. Part of what they should include in their research is a section on careers in mining.

Allow for some time at the beginning of this chapter to introduce the topic and the research project, and at the end for some feedback from the research projects.

3.1 Exploration: Finding minerals (0.5 hours)

Tasks	Skills	Recommendation
Activity: Mining in South Africa	Finding information, presenting information, group work, analysis, synthesis, application	CAPS suggested Project to be handed out at the beginning of the chapter.
Activity: Minerals and the right to own them	Debating, discussing	Optional

3.2 Extracting ores (0.5 hours)

Tasks	Skills	Recommendation
Activity: Gold mining in South Africa	Recall, comprehension, application	Suggested

3.3 Crushing and milling (0.5 hours)

(Perform demonstration with choc-chip biscuits in class to demonstrate crushing and milling)

3.4 Separating minerals from waste (1.5 hours)

Tasks	Skills	Recommendation
Activity: Separating beads	Group work, design, experimentation	CAPS suggested
Activity: Separating peanuts and raisins	Prediction, discovery, observation, explanation	Suggested

3.5 Refining minerals (1 hour)

Tasks	Skills	Recommendation
Activity: Separating lead from lead oxide	Observation, application	CAPS suggested

3.6 Mining in South Africa (2 hours)

Tasks	Skills	Recommendation
Activity: Create your own mining map	Translating information, application	Suggested
Activity: Drawing a mining flow diagram	Translating information, ordering information	Suggested
Activity: What would we do without mining?	Formulating an argument, group work, presentation skills, summarising information, synthesis	Suggested

Note: Allow for time at the end of this chapter for learners to present their research projects.



KEY QUESTIONS:

- How do we know where to mine?
- How do we get the valuable ore-rich rocks out of the ground?
- How do we get the minerals or metals out of the ore?
- How do we separate minerals from waste rock?
- How do we refine minerals?
- Where in South Africa are the mineral-rich deposits suitable for mining?
- What do we mine in South Africa?
- What is the impact of mining?

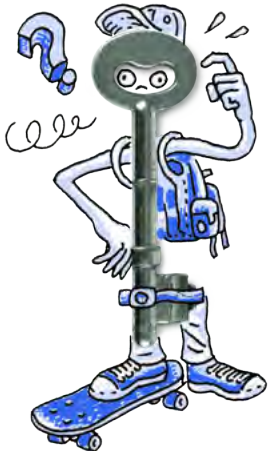

In the previous two chapters you have learnt about the spheres of the Earth especially the lithosphere. The lithosphere consists of rocks, which contain minerals. Minerals are natural compounds formed through geological processes. A mineral could be a pure element, but more often minerals are made up of many different elements combined. Minerals are useful chemical compounds for making new materials that we can use in our daily lives. In this chapter we are going to look at how to get the minerals out of the rocks and in a form that we can use. This is what the mining industry is all about.

Mining is a very important industry in South Africa. We have a lot of mineral resources in our country and a lot of people depend on mining for a living.

You already know that minerals in rocks cannot be used. Many processes are used to make minerals available for our use. We need to locate the minerals. We must determine whether these concentrations are economically viable to mine. Rocks with large concentrations of minerals, are called **ores**. Mining depends on finding good quality ore, preferably within a small area.

The next step is to get the rocks which contain the mineral out of the ground. Once the ore is on the surface, the process of getting the mineral you want out of the rock can start. Once the mineral is separated from the rest of the rock, the mineral needs to be cleaned so that it can be used.

This process can be represented by the following flowchart diagram:

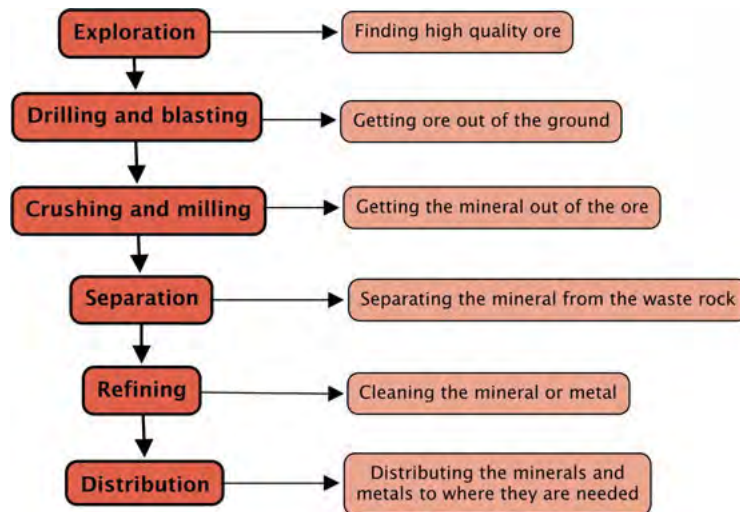

In this chapter we will look at each of the steps in more detail. You will also apply what you learn about mining to one specific mining industry. This is explained in the research project below.

ACTIVITY: Mining in South Africa

TEACHER'S NOTE

This project should be handed out in the beginning of the chapter so that learners have time to work on it. Information for the project is provided in the sections in the chapter, but learners also need to find information on their own. Guiding questions are provided to help learners.

You can use Assessment Rubric 8 (Poster), 9 (Oral presentation) and 10 (Group work) to assess this project.

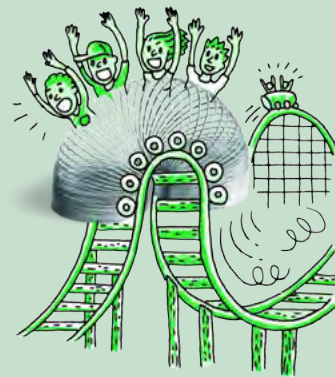

INSTRUCTIONS:

1. Work in groups of three.
2. Choose one mining industry in South Africa and find information about the industry of your choice.
3. Choose from the following list: gold, iron, coal, phosphate, manganese, diamond, chromium, copper and the platinum group metals (PGMs).
4. Present your findings to the class in an oral and a poster.
5. Use the following questions to guide your research:
 - a) How do geologists and engineers know where to mine for the mineral of your choice?
 - b) What type of mining method is used in this industry?
 - c) What processes are used to get the rock out of the ground?
 - d) What processes are used to reduce the size of the rocks?
 - e) How is the mineral removed from the ore?
 - f) How is the mineral separated from its compound?

- g) How is the mineral refined?
- h) Where in South Africa is this mineral mined?
- i) What has the impact of this mining industry been on South Africa?
- j) What has the impact of this mining industry been on the environment?
- k) What careers are involved in this mining industry?

3.1 Exploration: Finding minerals

One of the most important steps in mining is to find the minerals. Most minerals are found everywhere in the lithosphere, but in very, very low concentrations, too low to make mining profitable. For mining to be profitable, high quality ore needs to be found in a small area. Mining **exploration** is the term we use for finding out where the valuable minerals are.

Today technology helps mining geologists and surveyors to find high quality ore without having to do any digging. When the geologists and surveyors are quite sure where the right minerals are, only then do they dig test shafts to confirm what their surveying techniques have suggested.

Methods of exploration

In all these methods we use the properties of the minerals and our knowledge of the lithosphere to locate them underground, without going underground ourselves. For example, iron is magnetic so instruments measuring the changes in the magnetic field can give us clues as to where pockets of iron could be.

Exploration methods are used to find, and assess the quality of mineral deposits, prior to mining. Generally a number of explorative techniques are used, and the results are then compared to see if a location seems suitable for mining.

Remote sensing is the term used to gain information from a distance. For example, by using radar, sonar and satellite images, we can obtain images of the Earth's surface. These images help us to locate possible mining sites, as well as study existing mining sites for possible expansion.

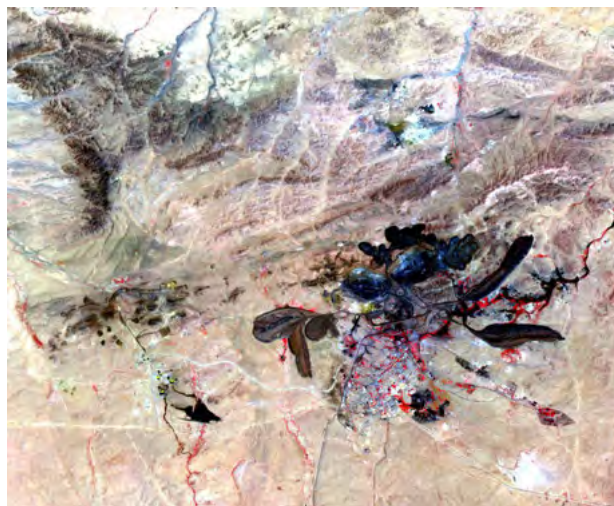

This image covers an area of 15 x 19 km and was taken from the NASA research satellite Terra. It shows the mine at Baiyun Ebo, China, which is the site of almost half the world's rare earth element production.

Geophysical methods make use of geology and the physical properties of the minerals to detect them underground. For example, diamonds are formed deep in the Earth at very high temperatures, in kimberlite pipes of igneous rock. The kimberlite pipe is a carrot shape. The first kimberlite pipe to be detected was in Kimberley in South Africa. The pipe was mined, eventually creating the Big Hole.



The Kimberley Big Hole was a diamond mine until 1914 when it closed down, and is now a tourist attraction.

Geochemical methods combine the knowledge of the chemistry of the minerals with the geology of an area to help identify which compounds are present in the ore and how much of it is present. For example, when an ore body is identified, samples are taken to analyse the mineral content of the ore.

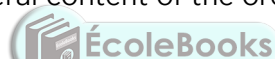

ACTIVITY: Minerals and the right to own them

TEACHER'S NOTE

This is an optional activity to conduct as a class discussion, or as small group discussions.

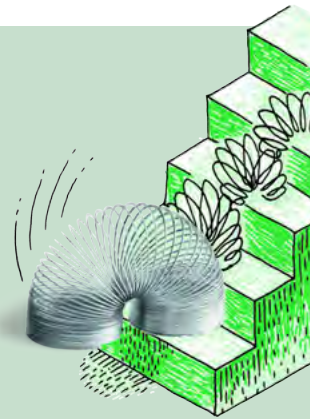

Many indigenous people, such as the San, share the same central belief that the land and all it produces are for all the people to use equally.

When colonialists arrived, they realised the potential mineral wealth of South Africa as gold, and later diamonds, were discovered. They ruthlessly took land from the local people wherever minerals were found, completely ignoring their right to ownership and access.

De Beers purchased the mining rights and closed all access to diamond mining areas. Anyone entering the area would be prosecuted and the sale of so-called 'illegal' diamonds was heavily punished. Other large mining companies have tried to claim the right to the minerals that they mine.

In groups, or as a class, discuss the following:

1. Should a few select people hold the right to the land and the minerals in it?
2. Who owns the minerals?
3. Should big corporations hold these rights?
4. What role should government play in allocating/administering mining rights?

Use the following space to write down some of the main points of your discussion.

3.2 Extracting ores

Once the ore body has been identified, the process of getting the ore out of the ground begins. There are two main methods of mining - surface mining and underground mining. In some locations a combination of these methods is used.

Surface mining

Surface mining is exactly what the word says - digging rocks out from the surface, forming a hole or pit. In South Africa, this method is used to mine for iron, copper, chromium, manganese, phosphate and coal. Surface mining is also known as open pit or open cast mining.

Let's look at coal as an example. For surface mining, the minerals need to be close to the surface of the Earth. Most of the coal found in South Africa is shallow enough for surface mining. Usually the rocks are present in layers. To expose the coal layer, the layers above it need to be removed. The vegetation and soil, called the **topsoil**, is removed and kept aside so that it can be re-deposited in the area after mining.



An open pit coal mine.

If there is a layer of rock above the coal face, called the **overburden**, this is also removed before the coal can be **excavated**. Once all the coal has been removed, the overburden and topsoil are replaced to help in restoring the natural vegetation of the area. This is called **rehabilitation**.

There is a growing emphasis on the need to rehabilitate old mine sites that are no longer in use. If it is too difficult to restore the site to what it was before, then a new type of land use might be decided for that area.



Replacing the overburden and topsoil

Preparing the topsoil for rehabilitation

Natural vegetation is restored

Surface mining coal and mine rehabilitation.

In Phalaborwa in Limpopo province, copper ore is mined using open pit mining.

The Phalaborwa open pit is one of the world's largest open pit mines. It is 2 km across and is the largest man-made hole in Africa.



Copper ore from Phalaborwa Mine.

VISIT

Read more about the Phalaborwa Mine.
bit.ly/1gXdBD3

VISIT

Coal surface mining - watch some of the heavy machinery in action.
bit.ly/17V4HFU

When you mine you are digging into solid rock. The rock needs to be broken up into smaller pieces before it can be removed. Holes are drilled in the rock and explosives, like dynamite, are placed inside the holes to blast the rock into pieces. The pieces are still very large and extremely heavy. The rocks are loaded onto very large haul trucks and removed. Sometimes the rocks (ore) are crushed at the mining site to make them easier to transport.

Do you remember learning about how coal is formed? What is coal made from?

TEACHER'S NOTE

This is revision of what learners have covered in previous grades. Coal is formed from fossilised plant matter which is compressed and heated over millions of years to eventually form coal.



A mining haul truck being loaded with coal.



Underground mining

Shaft mining

TAKE NOTE
Igneous and metamorphic rock is found where gold is mined.

Often the minerals are not found close to the surface of the Earth, but deeper down. In these cases underground mining, also called shaft mining, is used. Examples of underground mining in South Africa are mining for diamonds, gold and sometimes the platinum group metals (PGM).

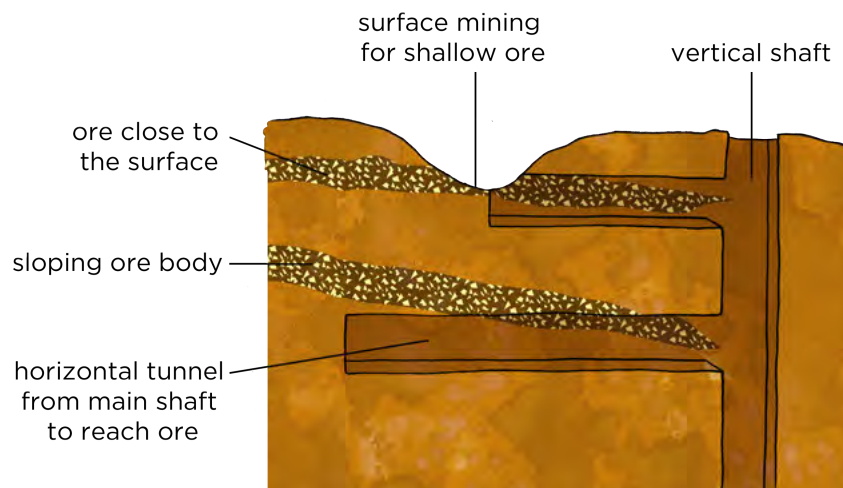

Extracting ore.

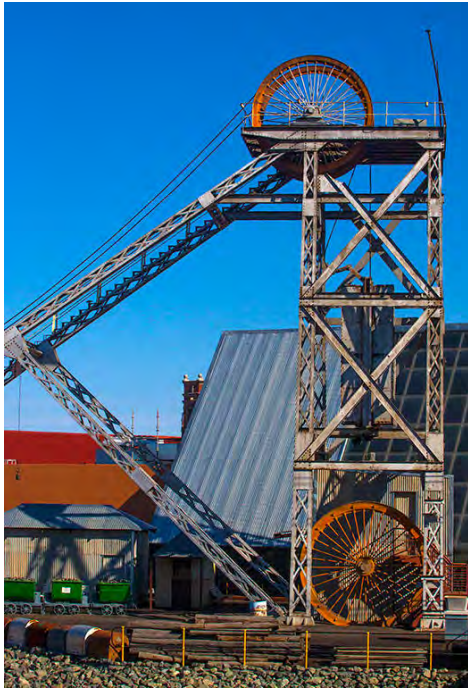

Old headgear at the Kimberley Mine in the Northern Cape

Sometimes the ore is very deep, which is often the case with diamonds or gold ore. In these cases mine shafts go vertically down and side tunnels make it possible for the miners and equipment to reach the ore.

A structure called the headgear is constructed above the shaft and controls the lift system into the vertical shaft. Using the lift, it can take miners up to an hour to reach the bottom of the shaft.

The TauTona Mine in Carletonville, Gauteng is the world's deepest mine. It is 3,9 km deep and has 800 km of tunnels. Working this deep underground is very dangerous. It is very hot, up to 55°C. To be able to work there, the air is constantly cooled to about 28 °C using air-conditioning vents.

ACTIVITY: Gold mining in South Africa

South Africa is a world leader in the gold mining industry. We have mining been gold for more than a century and our mines are the deepest in the world. Until 2010 we were the leading producer of gold in the world. Gold is a lustrous, precious metal which has a very high conductivity.

QUESTIONS:

1. What mining method is used to mine for gold?
Underground mining or shaft mining.
2. What type of rock is found where gold is mined?
Igneous rock, or metamorphic rock.
3. What is gold used for?
Jewelry, ornaments and decoration, electronics in computers and cell phones.
4. Do you think gold mining is dangerous? Why do you say so?
Yes it is, the mines are very deep, of the deepest in the world. Mining deep underground is difficult and dangerous because of the heat and lack of oxygen. Rocks can also collapse because of the pressure.



5. Provide labels for numbers 1-7 in the following diagram.

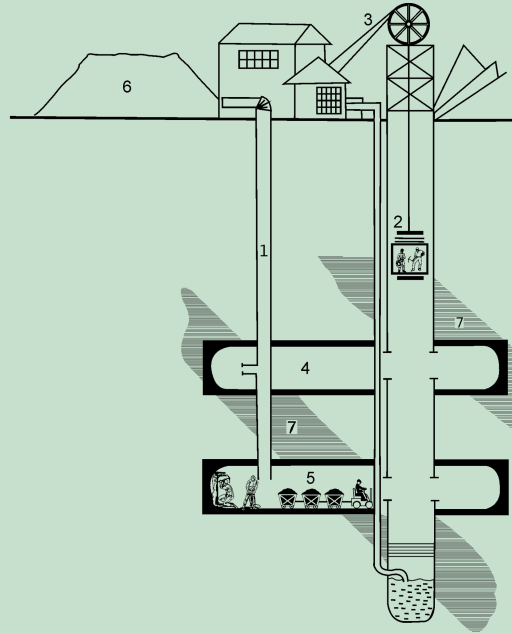

1. Air supply and air conditioners/heat control
2. Lift to take miners into the mine or down the vertical shaft
3. Headgear
4. Horizontal tunnel
5. Removal of ore
6. Mine dump
7. Ore body

Room and pillar method

One of the methods used in underground mining is called room and pillar, and is often used for mining coal. Part of the mine is open to the surface and part of it is underground. The coal face is dug out, but pillars of coal are left behind to keep the tunnels open and support the roof. Machines called continuous miners are used to remove the coal. The coal is loaded onto conveyor belts and taken up to the surface for further crushing.

VISIT

Underground mining.
bit.ly/16GcyTl



A machine called a continuous miner at work at the coal face.

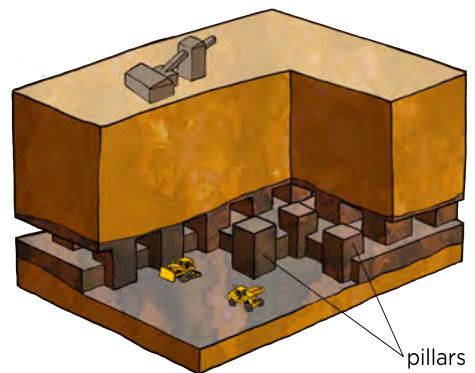

Room and pillar mining

What happens once the ore has been removed from the crust by mining?

3.3 Crushing and milling

TEACHER'S NOTE

This section looks at methods to get very large rocks crushed and ground until it is as fine as powder. The first concept that needs to come across here is that minerals are inside rocks and by crushing rocks, the minerals are exposed at the surface of the rock fragment. Only then can chemicals be used to extract the mineral. An analogy with a choc chip biscuit is used to demonstrate this principle. The second concept is that a lot of energy is needed to break rocks. This is a very energy-intensive step in the mining industry, and one of the reasons why mining is so expensive.

This lesson can be introduced by demonstrating the principle explained above to the class. Use choc chip biscuits and crush them with your fingers. This is to get the minerals (choc chips) out. The next step is to separate the choc chips from the crumbs - also a step in the mining process.

Mineral crystals are spread throughout rocks, just like chocolate chips are spread throughout a choc chip biscuit. Sometimes we can see the chocolate chips from the outside, but most of the time the chips are not visible because they are inside the biscuit.



Ore is like choc chip biscuits where the minerals are spread through the rocks.

The only way to find out how many choc chips there are is to crush the biscuit. In the same way we can sometimes see mineral crystals from the outside of the rock, but mostly we don't know what minerals there are and what concentrations are inside the rock. The only way to find out is to break the rock into smaller and smaller pieces.



The ore needs to be crushed, as a choc chip biscuit, to get the minerals out.

Once we have crumbled the choc chip biscuit, the chocolate pieces can be separated from the crumbs. In the same way in the mining process the valuable minerals can be separated from the unwanted rock. The unwanted rock is called waste rock.



The choc chips are separated from the rest of the biscuit, just as minerals are extracted from the rock.

Let's look at an example. You have learnt in the previous chapter that copper minerals are found in rocks. In South Africa, the Bushveld Igneous Complex is an area which stretches across the North West and Limpopo Provinces. Igneous rock with high mineral content is found here. Here they mine for PGMs, chromium, iron, tin, titanium, vanadium and other minerals using open pit and underground mining. The rocks from the mines are transported by conveyor belts to crushers. Jaw crushers and cone crushers break the huge rocks into smaller rocks.



Jaw crusher at a mine. The rocks are fed into the funnel and crushed as the two sides move back and forth.

VISIT
Short videos showing jaw crushers at work bit.ly/1f172ev and a ball mill turning bit.ly/1am13lf

The smaller rocks are then moved to mills where large rod mills and ball mills grind them further into even smaller pieces until it is as fine as powder.



TEACHER'S NOTE

You can demonstrate this to your class by placing some pieces of broken up biscuit into a plastic container with some marbles or ball bearings. Place the lid on the container and then shake it so that the marbles help to crush and break up the biscuit pieces even further.



A ball mill.

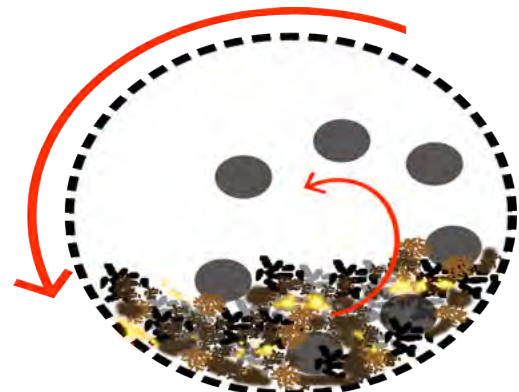

Inside a ball mill, the balls move round in a circle as the mill turns, crushing the ore into a powder.

This process of reducing the size of the rocks requires a lot of energy. Just imagine how hard it is to break a rock. How much more energy do you think is needed to crush a rock until it is like sand? This is one of the steps in the mining process that is very expensive because energy is needed to drive the process.

Most minerals are found as compounds in rocks. Only a few minerals are found in their pure form, in other words not bound to any other element. Examples of minerals found in their pure form are gold and diamonds (diamonds consist of the element carbon).



A rough diamond crystal embedded in rock.



A gold nugget.

Some rocks are used as is, and do not need to be crushed into powder, or involved in minerals extraction. For example phosphate rock itself can be used as a fertiliser, or it can be used to make phosphoric acid. Sand, or the mineral silicon dioxide (SiO_2) is used in the building industry.



Coal found in sedimentary rock, is crushed into the appropriate size and used as fuel for electricity generation or the iron-making process.

Lumps of coal can be used directly as a fuel. However some coal is first washed to make it into 'high grade coal'. It can also be sorted into various sizes, depending on what the fuel is required for.

3.4 Separating minerals from waste

Before the minerals can be used, they need to be separated from the waste rock. A number of different separation techniques are used. These techniques are based on the properties of the minerals. Different minerals are often found together, for example copper and zinc, gold and silver or the PGMs. A combination of techniques are used to separate the minerals from the waste and then the minerals from each other.

Hand sorting

Sorting by hand is not a very effective method to separate out the minerals you want. It can only be used in exceptional situation or by individuals, for example many people mine for alluvial diamonds by hand in rivers in Angola. It is a cheap and easy process to do individually, but it is not feasible on an industrial scale.

TAKE NOTE

An electromagnet, as we have learnt in Energy and Change, is a type of magnet in which the magnetic field is produced by electric current.

Magnetic separation

Iron is a metal with magnetic properties. Iron ore can be separated from waste rock by using magnetic separation techniques. Conveyor belts carry the ore past strong **electromagnets** which remove the magnetic pieces (containing the iron) from the non-magnetic waste. How do you think this works?

Which container, the left or the right, will contain the magnetic iron ore and which one will contain the non-magnetic waste? Label this on the diagram and provide a reason for your answer below.

TEACHER'S NOTE

The labelled diagram is provided here:

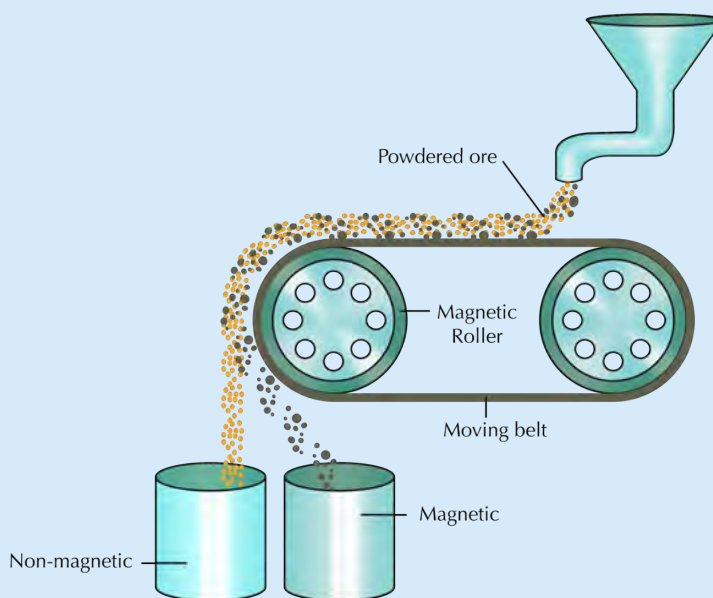

The magnetic iron ore will fall into the container on the right as it is attracted to the magnetic roller and travels around the bend of the magnet for a longer period, whereas the non-magnetic waste drops straight down due to gravity, as the magnet turns, and falls into the first container on the left.

TAKE NOTE

You might remember some of the different methods of physical separation from previous grades. This was covered in Matter and Materials.

Density separation

One of the first methods for mining gold was that of **panning**, a technique where ore is mixed with water and forms a suspension. When it is shaken, the dense particles of gold sink to the bottom and could be removed.



Panning.

ACTIVITY: Separating beads



TEACHER'S NOTE

Let the learners work in groups of three. The value of the activity is the process of doing it, and not so much the end product. Learners will want to separate every single bead in the process and this is not possible, nor does it happen in the mining industry. Valuable materials do end up as waste.

When choosing beads to separate, ensure that there are a variety of shapes, round and flat, small and large. Most plastic beads will float on water, but metallic ones will sink. The piece of carpet is provided to make the tray rough, but still smooth enough for round beads to roll off, and flat beads to stick. Choose the smallest flattest beads to represent the valuable materials. They will remain on the carpet in the tray more easily.

Learners might want to use the cups to separate by size. This is a great option. If magnetic beads are included, provide the learners with a magnet.

To separate by density, learners can drop the beads into water - some beads will float and others will sink. To separate by size, learners can use the mesh and let the smaller beads fall through into the cup, with the larger ones staying behind.

As an extension, include some beads which are identical in shape and size, but different colours. At this point, learners will want to hand sort them. Tell learners that hand sorting, although effective and is used by individuals, it is a very time-consuming process and therefore almost never done in the mining industry. Ask learners if they have any other ideas. This is where chemical properties come in. For example, tell learners that one colour bead reacts with an acid and the other does not. Get learners to discuss how they would then separate the beads knowing this. A real world example is that silver reacts with chlorine, but gold does not.

This activity can also be done as a class demonstration and some flow diagrams can be designed. The learners can then vote which one they think would work best.

In this activity you are going to separate beads as an analogy for separating minerals in the mining industry.

MATERIALS

- collection of beads, different shapes, sizes, densities and magnetic properties
- paint tray
- piece of carpet
- plastic cup and mesh
- magnet
- water

TEACHER'S NOTE

Optional is a sheet of paper for each learner for planning and making observations.



Different plastic and metal beads.



Materials needed for the activity.

INSTRUCTIONS:

1. Work in groups of three.
2. Your teacher will indicate to you which bead is the valuable mineral. You need to design a process to separate the valuable mineral from the waste rock.
3. Draw a flow diagram for the process you have designed. Consider using a number of steps in different orders. You may use the same technique more than once.
4. Also remember that repeating a technique improves the efficiency of it. Think about changing the order in which you separate the beads to see if you can find a more efficient process.
5. Hand sorting may NOT be used.

Use the following space to draw a final flow diagram of the process your group designed.

TEACHER'S NOTE

Learner-dependent answer

TAKE NOTE

Although hand sorting is an effective method, it is very time consuming which makes it an expensive process, so it is almost never used in the mining industry, except for diamond sorting.

QUESTIONS:

1. How did you sort the beads based on size?
Learner-dependent answer. Learners could have used the mesh and let the smaller beads fall through.
2. How did you sort the beads based on shape?
Learner-dependent answer. For example, some beads might have been flat and would therefore stick to the carpet, whereas the round ones would roll off.
3. How did you sort the beads based on density?
Some beads float and others sink.
4. How did you sort the beads based on magnetic properties?
The magnet can be used to lift magnetic beads out of the other beads.

As you have seen in the activity, separating a mixture can be done using different properties, depending on the different properties of the beads. There could be a number of different ways to separate the beads depending on which type of bead you want to select (considered to be the most valuable ones).

Size separation is used frequently in mining to classify ore. For example, when iron ore is exported, it needs to be a certain size to be acceptable to the world market. Coal that is used in power stations also needs to be a certain size so that it can be used to generate electricity effectively.

Density separation is used widely in mining, and you will see why in the next section.

Flotation

Flotation makes use of density separation, but in a special way.

Chemicals are added to change the surface properties of the valuable minerals so that air bubbles can attach to them. The minerals are mixed with water to make a **slurry**, almost like a watery mud. Air bubbles are blown through the slurry and the minerals attach to the bubbles. The air bubbles are much less dense than the solution and rise to the top where the minerals can be scraped off easily.



Separating minerals by flotation

ACTIVITY: Separating peanuts and raisins

You will be working in pairs for this activity. You need to observe carefully and explain your observations.

TEACHER'S NOTE

The focus of this activity is to illustrate the principle of flotation and for learners to practice explaining their observations. They will have to apply what they know about density to be able to explain what they see. This activity can also be modified by letting the learners predict what they think will happen before they add the peanuts and raisins to the tap water; and again before they add it to the soda water. The outcome might not be what they expected and the value of the activity is for them to try to explain what they see.

The peanuts will float because they are oily and the bubbles stick to them. This reduces the density of the peanuts so that they are able to float.

The activity can be done as a classroom demonstration, but it is more effective if done by the learners in pairs. The one learner can use the tap water, and the other the soda water. A suggestion is to buy packets of peanuts and raisins separately, otherwise oil from the peanuts can coat the raisins, causing some of the raisins to rise. The raisins can also be rinsed in acidulated water because they are often dressed with oil before sale for visual enhancement.

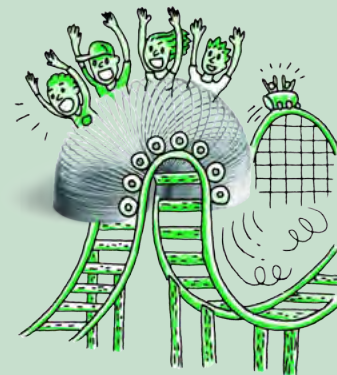

MATERIALS:

- peanuts
- raisins
- soda water
- tap water
- two tall glasses or beakers

INSTRUCTIONS:

1. Pour tap water into the first glass until it is about $\frac{3}{4}$ full.
2. Add a handful of the peanuts and raisin mixture to the water and note what happens.
3. Pour soda water into the second glass until it is about $\frac{3}{4}$ full.
4. Add a handful of the peanuts and raisin mixture to the soda water and note what happens.
5. Write down your observations.
6. Explain your observations.

VISIT
 A video of this activity can be found here.
bit.ly/190Fkj9



Peanuts and raisins.



Separating peanuts and raisins.



Looking down into the water filled beaker.

Use the following space to record and explain your observations.

TEACHER'S NOTE

Learners should observe that the peanuts and raisins sink to the bottom in the tap water and remain there since they are more dense than water. However, in the soda water, the peanuts and raisins initially sink to the bottom, but then the peanuts start to rise. Small bubbles from the soda water attach to the peanuts' oily surface and cause them to rise to the surface.

The methods mentioned so far are all **physical separation methods**. Sometimes they are sufficient to separate minerals for use, like coal or iron ore. But more often the element that we are looking for is found as a chemical compound, and so will have to be separated by further chemical reactions. For example, copper in Cu_2S or aluminium in Al_2O_3 .

What is the name for the force that is holding atoms together in a compound?

TEACHER'S NOTE

A chemical bond.

Once the compound is removed from the ore, the element we want needs to be separated from the other atoms by chemical means. This process forms part of refining the mineral, as you will see in the next section.

VISIT

Ore to more: Copper mining.
bit.ly/198EKBR

3.5 Refining minerals

There are many different methods used to concentrate and refine minerals. The choice of methods depends on the **composition** of the ore. Most of the methods however, make use of chemistry to extract the metal from the compound or remove impurities from the final product. We will discuss the extraction of iron from iron ore as an example.

Extraction of iron

Iron atoms are found in the compounds FeO, Fe₂O₃ and Fe₃O₄ and in rocks like haematite and magnetite. South Africa is the seventh largest producer of iron ore in the world. Iron has been mined in South Africa for thousands of years. South African archaeological sites in Kwa-Zulu Natal and Limpopo provide evidence for this. Evidence of early mining activities was found in archaeological sites dating mining and smelting of iron back to the Iron Age around 770 AD.

The first iron mining techniques used charcoal which was mixed with iron ore in a **bloomery**. When heating the mixture and blowing air (oxygen) in through **bellows**, the iron ore is converted to the metal, iron. The chemical reaction between iron oxide and carbon is used here to produce iron metal. The balanced chemical equation for the reaction is:

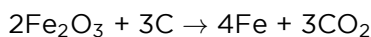

A small bloomery.

This extraction method is still used today using the chemistry. However, the bloomery is replaced with a **blast furnace**, a huge oven where iron ore is burned with oxygen and coal to produce the metal, iron. Iron ore, a type of coal called coke (which contains 85% carbon) and lime are added to the top of the blast furnace. Hot air provides the oxygen for the reaction. The temperature of a blast furnace can be up to 1200°C.

VISIT

Simple animation showing a
blast furnace.
bit.ly/16HWGLb

The reaction takes place inside the furnace and molten iron is removed from the bottom. Lime (calcium carbonate or CaCO_3) is added to react with the unwanted materials, such as sand (silicon dioxide or SiO_2). This produces a waste product called **slag**. The slag is removed from the bottom and used for building roads. Iron is used to make steel. Hot gases, mainly carbon dioxide, escape at the top of the furnace.

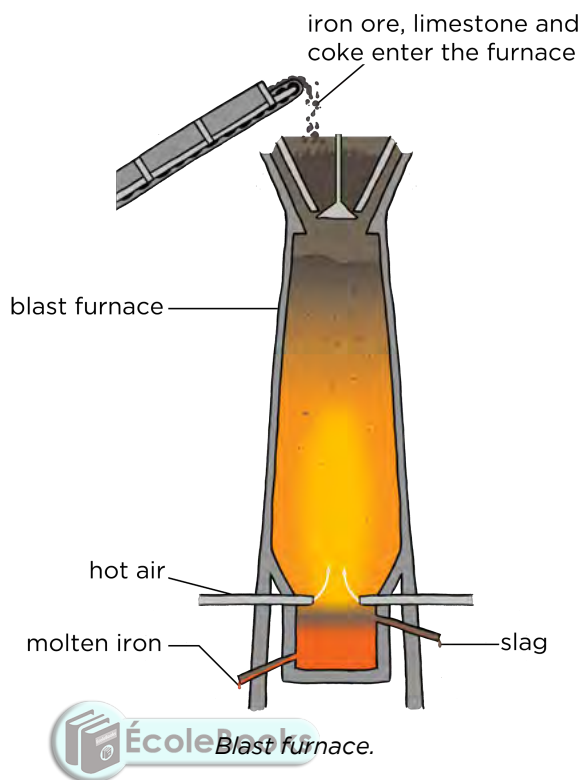

VISIT

An interesting video showing how a traditional pit furnace worked. A group of archeologists spent a weekend building an iron furnace and then used it to extract iron. Part 1: bit.ly/1abJX7 Part 2: bit.ly/1dky3sR

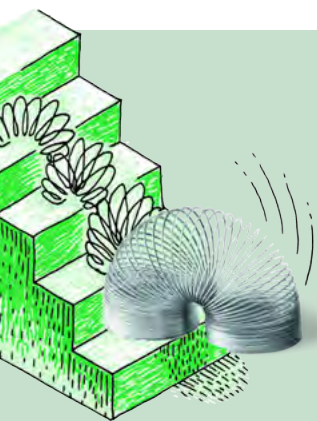

ACTIVITY: Separating lead from lead oxide

TEACHER'S NOTE

For safety reasons, this experiment should rather be demonstrated. Ensure that you wear safety glasses when performing this experiment. It is quite easy to do, but takes a long time to actually react. The blow pipe needs to redirect the flame into the hollow in the block. Blow through the top of the blue part of the flame. Use a straw to extend the blow pipe so that you can stand a bit further away from the flame. Ensure that a steady stream of heat gets right into the middle of the mixture so that it glows red hot for a while. The video link in the Visit box also shows how the experiment is performed (and the mistakes made). The product can clearly be seen in the video.

In this demonstration you are going to react lead(II) oxide with carbon. This is similar to the process used in iron mining where iron ore is reacted with coke (carbon) to form iron metal.



Lead(II) oxide.

MATERIALS:

- lead(II) oxide (red)
- charcoal block
- Bunsen burner
- blowpipe
- spatula
- safety glasses

INSTRUCTIONS:

1. Use safety glasses in this experiment.
2. Use the spatula to scrape a hollow in the charcoal block. Ensure that the loosened carbon remains in the hollow.
3. Add an equivalent amount of lead oxide to the carbon in the hollow.
4. Add a drop or two of water to make a paste.
5. Use a blow pipe to direct the flame of the Bunsen burner into the hollow where the lead(II) oxide-carbon paste is. Create a steady flow of air through the flame.
6. Keep the flame directed onto the paste for 2-3 minutes.
7. Observe if any changes has taken place. If not, continue blowing for another minute.

QUESTIONS:

1. What have you observed? Were there any colour changes? Describe your observations.
The mixture heats up and starts to glow. At the end of the reaction the red colour of the lead oxide has changed to a grey colour and a solid pellet of lead has formed.
2. Write a balanced equation for the reaction that has taken place.
 $2\text{PbO} + \text{C} \rightarrow 2\text{Pb} + \text{CO}_2$
3. Carbon dioxide is formed in this reaction. What would the impact of this be if the reaction is done on large scale?
Carbon dioxide is a greenhouse gas and large scale production will negatively influence the environment and contribute to global warming.

VISIT

Making lead from lead oxide.

bit.ly/16imQH8

TAKE NOTE

Remember from Matter and Materials that lead (II) oxide is formed from the reaction between lead (a metal) and oxygen.

In this experiment carbon was used to remove the oxygen from the lead(II) oxide. The carbon and oxygen form carbon dioxide, and the lead is left behind as a metal. This is the same process that is used in iron extraction in the blast furnace, that we discussed above. Coke, which is mainly carbon, removes the oxygens from the iron(III) oxide to form carbon dioxide and leaves behind the iron metal.

Refining iron

The iron that is formed in the blast furnace often contains too much carbon - about 4% where it should contain not more than 2%. Too much carbon makes the iron **brittle**. To improve the quality of the iron, it needs to be refined by lowering the amount of carbon. This is done by melting the metal and reacting the carbon with pure oxygen to form carbon dioxide gas. In this way the carbon is burned off and the quality of the iron improves. The iron can now be used in the steel-making process. Carbon reacts with oxygen according to the following chemical equation:

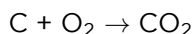

Most minerals go through chemical extraction and refining processes to purify them for use in making materials and other chemical products. These are then distributed to where they are needed, for example, coal is distributed to coal power stations and slag is distributed to construction groups for building roads. The mining industry supplies the manufacturing industry and the chemical industry with its raw materials, for example iron is distributed to steel manufacturing industries.

3.6 Mining in South Africa

Long before diamonds were discovered in the Kimberley area and the Gold Rush in Pilgrim's Rest and Witwatersrand areas in the late 1800s, minerals have been mined in South Africa. At Mapungubwe in the Limpopo Province evidence of gold and iron mining and smelting was found which dates back to the early 11th century AD. However, it was the large scale mining activities that accelerated the development of the country.

South Africa has a wealth of minerals. We are the world's largest producers of chromium, manganese, platinum, vanadium and andalusite; and the second largest producer of ilmenite, palladium, rutile and zirconium. We are the third largest coal exporter, fifth largest diamond producer and seventh largest iron ore producer. Up to 2010 we were the world's largest gold producer, but our gold production has declined steadily over a number of years. We are currently fifth on the list of gold producers.

VISIT

Steel is a very important material in the modern world. A series of videos on iron and steel can be found here bit.ly/1cnWys7

VISIT

Watch an experiment to extract copper from copper ore. bit.ly/16HX0cl

VISIT

The world's deepest mine in South Africa (video). bit.ly/1am1oV2



The Okiep Copper Mine, South Africa, established in the 1850s, is one of the richest bodies of copper ore ever found to this day.

Minerals are mostly found in the northern part of the country. They are often concentrated in specific areas which are linked to the geology of the area.

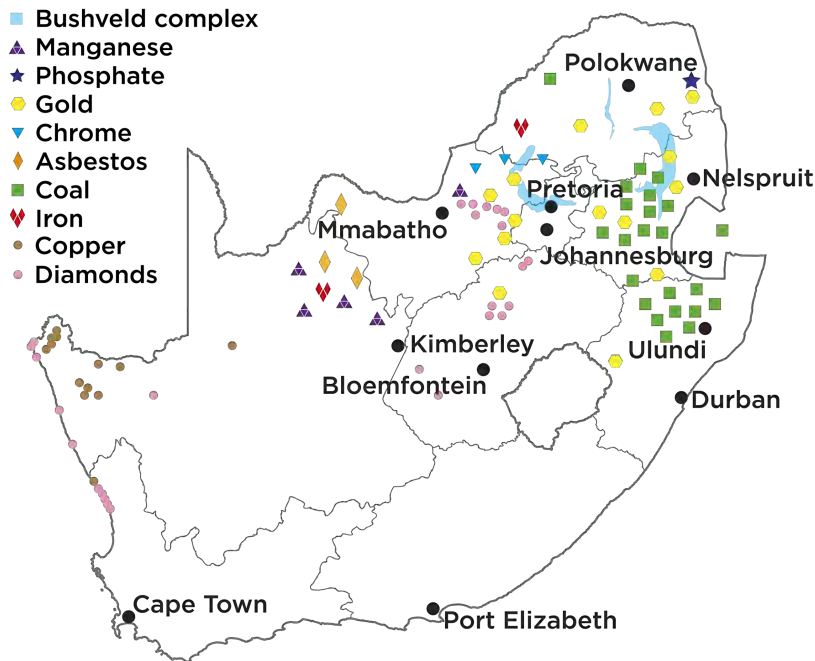

Minerals in South Africa

The Bushveld Igneous Complex has the world's largest primary source of platinum group metals, indicated on the map in light blue. It is one of the most important mining areas in South Africa due to its abundance of minerals.



The Cullinan Premier Diamond Mine, near Pretoria, Gauteng.

VISIT
 South Africa's mining crisis.
bit.ly/HswbTe



ACTIVITY: Create your own mining map

TEACHER'S NOTE

Learners need to develop their own symbols for each mineral that is mined, and also colour code the map. The map is blank and so they must find out where each town is located and add it to the map. Let them also fill in the name of the city/town/area in which they live. If there are mining activities in your area which is not indicated on this table, let the learners add it to the list. The list provided is not exhaustive, but it is still fairly long. If you want to make the activity simpler, learners can also chose a certain number of minerals to represent.

INSTRUCTIONS:

1. Use the map of South Africa and the data provided in the table below to draw your own map of where mining in South Africa takes place. You will need to find out where the towns are located in South Africa and indicate them on the map.
2. Your teacher will indicate whether you must show all the locations, or a selection of the ones provided.
3. You need to decide on a key for your map and appropriate labels.
4. Also complete the table by filling in the chemical symbols or formulae and answer the questions that follow.

Mineral	Chemical symbol/ formula	Where it is found
Lead		Aggenys
Andalusite	Al_2SiO_5	Namakwaland; north of Lydenburg; Eastern Bushveld Complex
Zinc		Aggenys; between Vryburg and Kuruman
Iron		Vredendal; Postmasburg; Sishen/Kathu, Thabazimbi
Salt		Port Elizabeth; Velddrif; between Prieska and De Aar; Douglas; Koffiefontein; Jacobsdal; Petrusburg, Upington
Limestone		Port Elizabeth; Port Shepstone; Saldanha; Lichtenburg; Mahikeng; Zeerust; between Christiana and Bloemhof; West of Thabazimbi

Mineral	Chemical symbol/ formula	Where it is found
Vermiculite	$(\text{Mg,Fe}^{2+},\text{Al})_3(\text{Al,Si})_4\text{O}_{10}(\text{OH})_2 \cdot 4(\text{H}_2\text{O})$	Between Pietermaritzburg and Durban; east of Musina; west, south and east of Makhado, Phalaborwa
Diamonds		Kimberley; northwest of Kimberley; Alexander Bay; Luderitz; Port Nolloth; on the west coast north of Vredendal; Mahikeng; north of Ventersdorp; Cullinan; west of Musina
Titanium		West coast north of Saldanha Bay; Richards Bay
Manganese		North of Kuruman; northeast of Ventersdorp
Zirconium		West coast north of Saldanha Bay; Richards Bay
Gold		Virginia; Welkom; Stilfontein; Klerksdorp; Potchefstroom; Carletonville; Johannesburg, Vereeniging; Vryheid[, Barberton; west of Phalaborwa; Evander
Chromium		Western Bushveld Complex; Eastern Bushveld Complex
PGMs		Western Bushveld Complex; Eastern Bushveld Complex; Northern Bushveld Complex
Phosphate		Phalaborwa
Coal		Virginia; Welkom; Bothaville; Kroonstad; Vereeniging; Sasolburg; Vanderbijlpark; Dundee; Newcastle; Utrecht; Vryheid; Ermelo; Standerton; Secunda; Evander; Witbank; Middleburg; Carolina; Lephalale
Nickel		West of Barberton
Copper		Aggenys/Springbok; Phalaborwa; Western Bushveld Complex; Eastern Bushveld Complex
Antimony		West of Phalaborwa

QUESTIONS:

1. What mineral(s) are mined closest to where you live?
Learner-dependent answer.
2. What do you notice about the gold mines in South Africa?
Most of them are all together in one area in the shape of an arch, mainly in the Free State.
3. There are two types of diamond mining, alluvial (which is found on the coast or in inland rivers which have washed through kimberlite pipes) and kimberlite (which is found inland). What is the link between these two types of diamond mining?
Diamonds from inland were washed to the coast by rivers. These diamonds are now mined from alluvial deposits at the coast.
4. Which mining industry do you think is the best or most important one in South Africa? Give a reason for your answer.
Learner-dependent answer. Accept any mining industry as long as an appropriate reason is given. For example, coal mining because it provides us with energy.



ACTIVITY: Drawing a mining flow diagram

INSTRUCTIONS:

1. Choose one mining industry mentioned in this chapter. It can be the one you are doing your research project on.
2. Draw a flow diagram to show the different steps in the mining of the chosen mineral.
3. End your flow diagram with something or somewhere where this mineral is used in real life. Look at the beginning of the chapter for a generic flow diagram for mining.

Use the following space for your flow diagram.

TEACHER'S NOTE

This activity is meant to consolidate the knowledge from this chapter. Each industry will have its own unique flow diagram. The idea is for the learners to realise that it is a continuous system where the one process feeds into the next one to produce a useful end product. This activity links up with the research project and should give learners a good guide for doing and presenting their research projects.

The answers depends on the mineral chosen. Below is an example:

Coal mining: Finding coal seams through exploration in Mpumalanga, Free State and KwaZulu Natal → mining for coal using open pit mining → removing the coal by blasting and drilling → loading onto haul trucks and removing from mine → crushing the coal → sorting into different sizes → distribution to power stations → electricity generation



The impact of mining

Mining has played a major role in the history of South Africa. It accelerated technological development and created infrastructure in remote areas in South Africa. Many small towns in South Africa started because of mining activity in the area. It also created a demand for roads and railways to be built. Most importantly it created job opportunities for thousands of people. Even today many households are dependent on the mining activities for jobs and an income. Mining is an important part of our economic wealth. We export minerals and ore to many other countries in the world.

Mining activities also have a negative impact on the environment. In many cases the landscape is changed. This applies particularly to surface mines (open pit mines), where large amounts of soil and rock must be removed in order to access the minerals.

The shape of the landscape can be changed when large amounts of rocks are dug up from the Earth and stacked on the surface. These are called mine dumps. Open pit mines also create very large unsightly and dangerous holes (pits) in the ground that change the shape of the land.

Air and water pollution can take place if care is not taken in the design and operation of a mine. Dust from open pit mines, as well as harmful gases such as sulphur dioxide and nitrogen dioxide, could be released from mining processes and contribute to air pollution. Mining activities produce carbon dioxide. Trucks and other vehicles give off exhaust gases.

If the mining process is not monitored properly, acid and other chemicals from chemical processing can run into nearby water systems such as rivers. This is poisonous to animals and plants, as well as to humans who may rely on that water for drinking.

An example are pollutants (dangerous chemicals), called tailings, left over from gold mining which pose a threat to the environment and the health of nearby communities. Dangerous waste chemicals can leak into the groundwater and contaminate water supplies if the tailings are not contained properly.

VISIT

The price of gold: Chinese mining in Ghana.

bit.ly/1aQ8cFk

TAKE NOTE

Tailings are the materials left over after separating the valuable minerals from the ore.



An aerial photograph of Primrose Gold Mine. Can you see the piles of gold tailings on the left of the photograph?

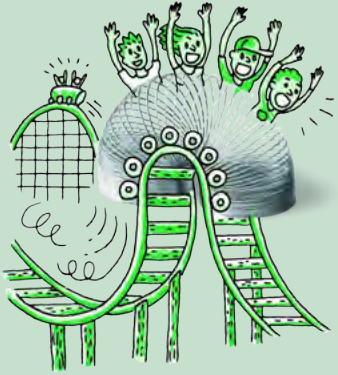

ACTIVITY: What would we do without mining?

INSTRUCTIONS:

1. Imagine all the mines in South Africa close down. What do you think would be the impact on the points outlined below?
 - a) Carbon emissions
 - b) Jobs
 - c) Economy
 - d) Future of small towns
 - e) Add one of your own issues here
2. Discuss the following aspects with your group.
3. Present your discussion to the class in a few short sentences on each issue.

TEACHER'S NOTE

There are no specific answers for this activity. It is an open discussion. We suggest that you discuss the impact of mining in South Africa through this activity. The idea is that learners should come up with all the issues and think about the impact of what we as humans do. The answer to solving the issues is not necessarily to close down all mining activity.

As an alternative you can get the learners to write a paragraph on each issue, after discussing it in their groups, instead of presenting it in the classroom.

SUMMARY:

Key Concepts

- People extract valuable minerals from the lithosphere.
- Rock that contains high concentrations of valuable minerals are called ore.
- Various methods are used to locate potential sites for mining.
- Ore is removed from the crust by mining, either on the surface (open pit mining) or underground (shaft mining or room and pillar mining).
- Some minerals can be used in their natural form, for example sand in the building industry, phosphate rock for fertilisers and diamonds in jewellery.
- Some minerals require a physical and/or chemical process to remove them from the ore.
- Large rocks containing minerals need to be crushed and milled.
- The valuable minerals are then separated from the rock using a variety of physical and chemical separation methods.
- People have extracted minerals, for example iron and copper, from ores for thousands of years.
- Examples of how minerals were mined long ago can be found at archaeological sites in South-Africa, such as Mapungubwe.
- Today iron is extracted using coke (carbon) to make steel.
- South Africa has a large mining industry.
- The industry creates jobs and contributes to the economy.
- The mining industry has a significant impact on the environment.

Concept Map

Use the following concept map to summarise what you have learnt in this chapter about mining of mineral resources. What are the three types of mining that we discussed in this chapter? Fill these into the concept map. Remember that you can add in your own notes to these concept maps, for example, you could write more about the environmental impacts of mining.



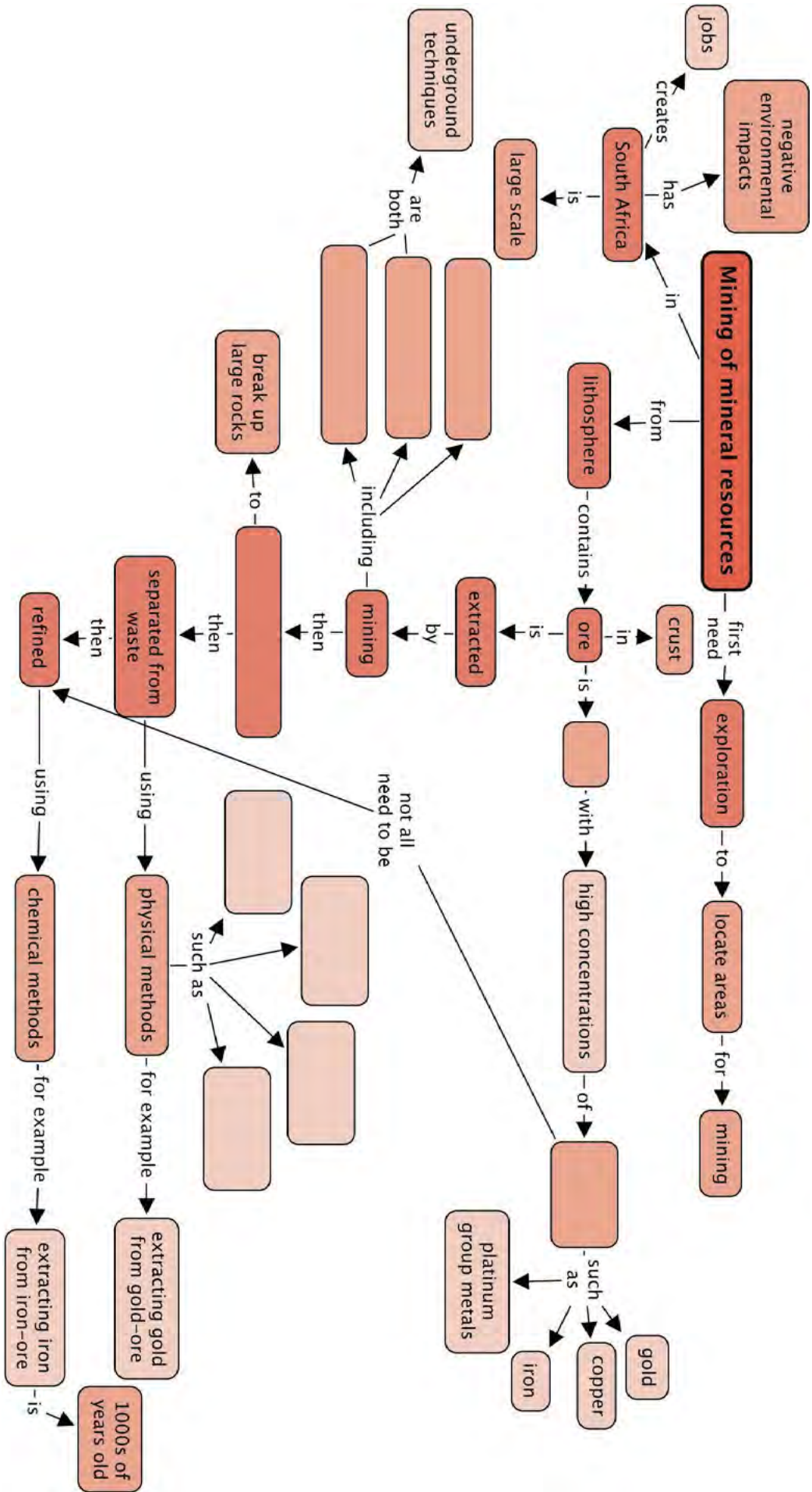

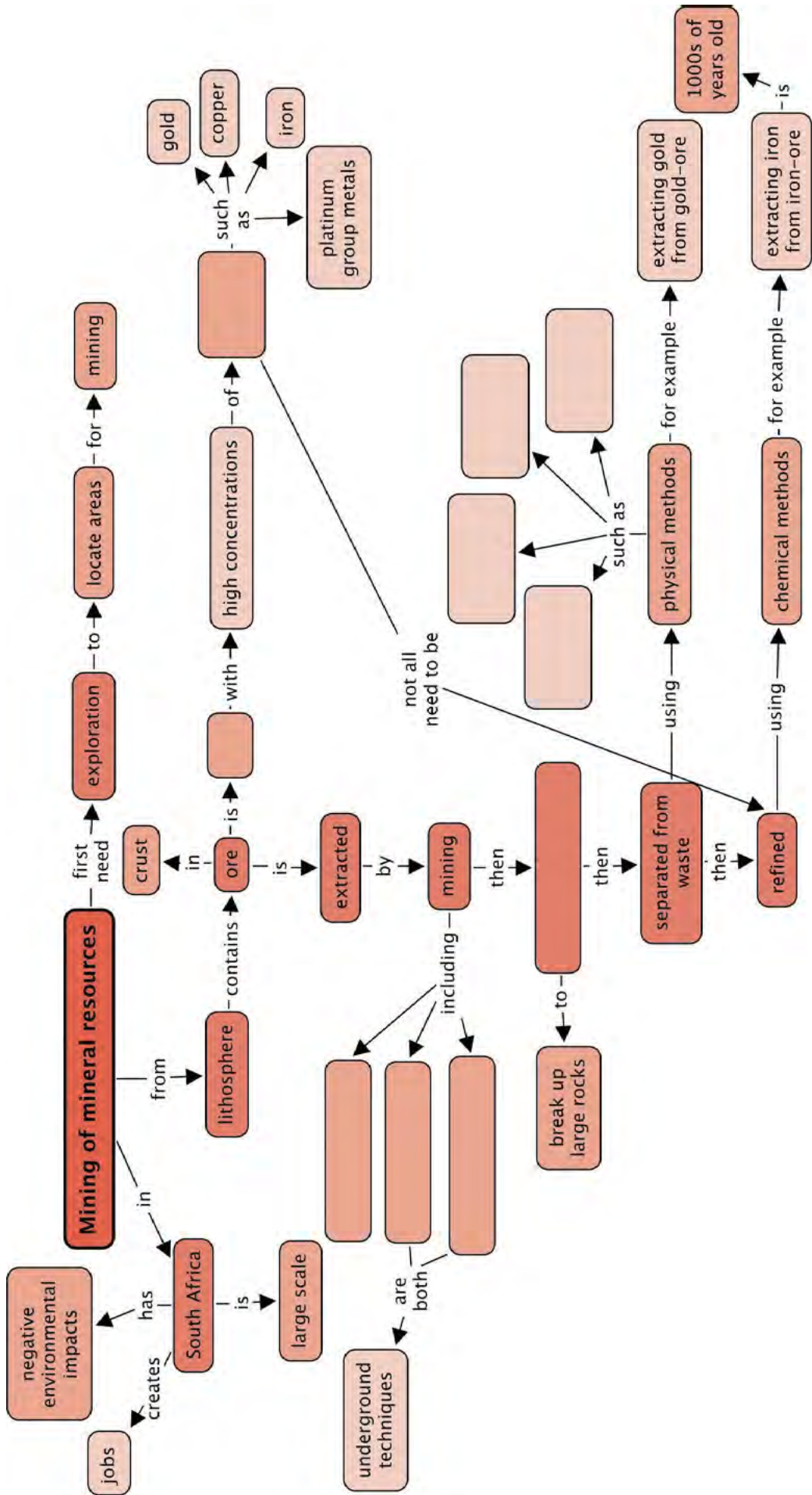

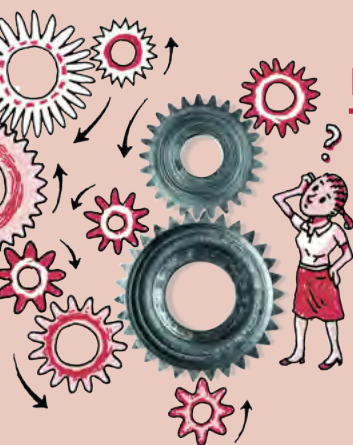

REVISION:

1. Bauxite is an aluminium ore that contains four different minerals: Al_2O_3 , SiO_2 , TiO_2 and Fe_2O_3 .



Bauxite.

- a) What are the chemical names of each of these minerals? [4 marks]
 - b) Bauxite is found close to the surface of the Earth. What type of mining would you expect to be used in bauxite extraction? [1 mark]
 - c) What is the common name for SiO_2 ? [1 mark]
 - d) SiO_2 is present as unwanted material in the iron blast furnace and needs to be removed. How is it removed and what is the waste product used for? [2 marks]
 - e) Bauxite also contains iron(III) oxide. Write down the common name for iron(III)oxide. [1 mark]
 - f) Suggest one way of separating the iron (III) oxide from the rest of the minerals in bauxite. Give a reason for your answer. [2 marks]
- a) Al_2O_3 : Aluminium oxide
 SiO_2 : Silicon dioxide
 TiO_2 : Titanium dioxide
 Fe_2O_3 : Iron(III) oxide
 - b) Open pit mining/surface mining.
 - c) Sand. Learners could also answer quartzite or quartz.
 - d) Lime is added to react with the sand (SiO_2) to form slag. Slag is used for making roads.
 - e) Haematite or magnetite.
 - f) Magnetic separation, as iron is magnetic, whereas the other minerals are not.
2. Explain how iron is extracted from iron ore. [6 marks]
 - a) Iron ore, coke and lime are added to the top of a furnace.
 - b) Hot air is blown in from the bottom.
 - c) The furnace operates at a high temperature (around 1200°C).
 - d) Iron ore reacts with carbon/coke to form iron metal and carbon dioxide.
 - e) The iron is tapped off at the bottom of the furnace.
 - f) Slag is a by-product which is also collected and can be used for building roads.

3. Write a balanced equation for the extraction of iron from its ore. [3 marks]
 $2\text{Fe}_2\text{O}_3 + 3\text{C} \rightarrow 4\text{Fe} + 3\text{CO}_2$
4. What is the environmental impact of the iron mining process? [2 marks]
CO₂, a greenhouse gas, is given off in large quantities. This contributes to global warming.
5. Case study: Read the following article and answer the questions that follow.

The story of Loolekop

Phalaborwa is home to one of the largest open pit mines in the world. The original carbonate outcrop was a large hill known as Loolekop. Archaeological findings at Loolekop revealed small scale mining and smelting activities carried out by people who lived there long ago. An early underground mine shaft of 20 meters deep and only 38 centimeters wide were also found. The shafts contained charcoal fragments dating the activities to 1000 - 1200 years ago.

In 1934 the first modern mining started with the extraction of apatite for use as a fertiliser. In 1946 a well known South African geologist Dr. Hans Merensky started investigating Loolekop and found economically viable deposits of apatite in the foskorite rock. In the early 1950s a very large low grade copper sulfide ore body was discovered.

In 1964 the Phalaborwa Mine, an open pit copper mine, commenced its operations. Today the pit is 2 km wide. Loolekop, the large hill, has been completely mined away over the years. A total of 50 different minerals are extracted from the mine. The northern part of the mine is rich in phosphates and the central area, where Loolekop was situated, is rich in copper. Copper with the co-products of silver, gold, phosphate, iron ore, vermiculite, zirconia and uranium are extracted from the rocks.

The open pit facility closed down its operation in 2002 and has now been converted to an underground mine. This extended the lifetime of the mine for another 20 years. The mine employs around 2500 people.

2000 million years ago this area was an active volcano. Today the cone of the volcano is gone and only the pipe remains. The pipe is 19 km² in area and has an unknown depth, containing minerals like copper, phosphates, zirconium, vermiculite, mica and gold.

This mine was a leader in the field of surface mining technology with the first in-pit primary crushing facility. This meant that ore was crushed by jaw crushers before taken out of the mine. They also used the first trolley-assist system for haul trucks coming out of the pit. Today the mine has secondary crushing facilities, concentrators and a refinery on site.

In 1982 a series of cavities with well-crystallised minerals were discovered, for example calcite crystals up to 15 cm on edge, silky mesolite crystals of up to 2cm long and octahedral magnetite crystals of 1-2 cm on the edge.



Mesolite crystals.



Hematite crystals.



Calcite crystals.

- What type of rock would you find in the Phalaborwa mine? Give a reason for your answer. [2 marks]
 - Why did the open pit facility closed down in 2002? [2 marks]
 - What is phosphate rock used for? [1 mark]
 - What has the impact of the Phalaborwa Mine been on the landscape? [1 mark]
 - How was it possible for very large crystals to form? [1 mark]
 - What are the environmental impacts of open pit mining? Name any three. [3 marks]
- a) Igneous rock, it was a volcano.*
b) They could not mine any deeper and they had exhausted the minerals that could be reached from the surface.
c) Fertilisers.
d) It changed dramatically because an entire koppie, called Loolekop, was removed due to the mining activity.
e) The igneous rock in the pipe cooled slowly allowing large crystals to grow over time.
f) Dust pollution, noise pollution, changing the landscape, carbon dioxide emissions (any three).

Total [32 marks]





TEACHER'S NOTE**Chapter overview**

2 weeks

The first chapter in the Planet Earth and Beyond strand looked at the spheres of the Earth. The atmosphere was briefly introduced in this chapter and is now covered in more detail.

The atmosphere is the layer of gases around the Earth. The important concepts that need to be understood in this chapter are:

- the air we breathe does not contain 'nothing', but rather an important mix of gases which support and sustain life on Earth
- gravity causes the density gradient in the atmosphere, and makes the atmosphere 'stick' to Earth
- the temperature in the atmosphere varies with altitude as a result of radiation from the Earth, the specific gases present at different altitudes, chemical reactions taking place in the atmosphere, and the energy from the Sun.

The concept of space and the 'nothingness' that we breathe might be difficult for learners to comprehend. We have included a number of models and pictures to help them visualise the vastness of space, and understand that the atmosphere, which surrounds us, is required for life on this planet.

A common misconception is that land plants generate most of the oxygen in the atmosphere, whereas this actually occurs in the oceans where 70% of the planet's oxygen supply is produced.

Direct sunlight does not heat the atmosphere. Only a small portion of the heating can be accounted for by direct sunlight, most of the heating is through conduction, convection and re-radiation of the Sun's energy.

Another misconception is that greenhouse gases make up a major part of the atmosphere. Nitrogen and oxygen make up 99% of the atmosphere while other gases, including greenhouse gases, make up only about 1%.

4.1 What is the atmosphere? (1 hour)

Tasks	Skills	Recommendation
Activity: How thick is the atmosphere compared to the size of the Earth?	Measurement, interpretation, representing information	Suggested

4.2 The troposphere (0.5 hours)

Tasks	Skills	Recommendation
Activity: Drawing a graph of the temperature gradient in the troposphere	Drawing graphs, doing calculations, measuring	CAPS suggested

4.3 The stratosphere (0.5 hours)

4.4 The mesosphere (0.5 hours)

4.5 The thermosphere (1 hour)

Tasks	Skills	Recommendation
Activity (model building): How thick are the layers of the atmosphere?	Building a model, drawing diagrams, data handling	Suggested

4.6 The greenhouse effect (2.5 hours)

Tasks	Skills	Recommendation
Activity: Comparing the Earth, Mars and Venus	Interpreting data, providing explanations, application	Suggested
Investigation: A model of the greenhouse effect	Building a model, data collection, data analysis, interpreting results, drawing conclusions	CAPS suggested
Investigation: Ice core analysis	Interpreting data, formulating, investigative questions, drawing conclusions, representing data	Suggested

KEY QUESTIONS:

- What is the atmosphere?
- What makes up the atmosphere?
- Does the atmosphere change as you go further from the Earth's surface?
- Can the atmosphere be divided into different layers?
- Where does the atmosphere end?
- What important aspect of the atmosphere allows life to exist on earth?
- What is the greenhouse effect?
- How do humans contribute to the greenhouse effect?



In the first chapter of Planet Earth and Beyond, you learnt about the different spheres of the Earth. The atmosphere was mentioned briefly in Chapter 1. In this chapter we will look at the atmosphere in more detail.



Photograph of the Earth's atmosphere taken from the International Space Station. You can see the curved Earth below the bright atmosphere - a very thin layer of gases around the Earth. Above and beyond the atmosphere is where we find outer space. The bright spot is the Sun just going below the horizon.

4.1 What is the atmosphere?

The atmosphere is the layer of gases which surrounds the Earth. It contains the following mixture:

- nitrogen (78,08%)
- oxygen (20,95%)
- argon (0,93%)
- carbon dioxide and other trace gases (0,04%)

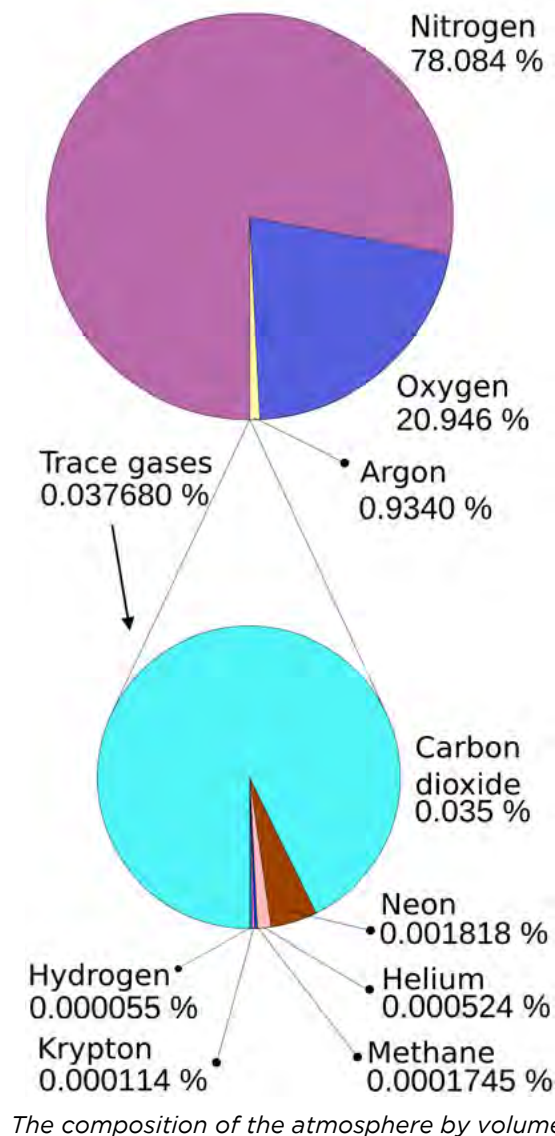

VISIT
 Reveal Earth's atmosphere.
bit.ly/1g7rDki

TAKE NOTE
 The exosphere is not considered part of the atmosphere due to the very low density of gases, but it is still briefly discussed in this chapter. In some other resources which you may look at, the exosphere is sometimes discussed as a layer or upper limit of the atmosphere.

The gas molecules in the atmosphere are kept close to the Earth by gravity. The effect of gravity means that there will be more gas molecules closer to the Earth's surface than further away. As you move further and further away from the surface of the Earth, the gas molecules become fewer and the spaces between the molecules become larger, until there are no more gas molecules and only spaces left. The atmosphere therefore does not have a set boundary, but rather fades away into space.

When we walk up a very high mountain, there is less oxygen present. We may feel out of breath. People sometimes say that the air is thinner higher up. When they say this they mean that there is a lower concentration of oxygen molecules.

TAKE NOTE
Sports teams and athletes need to acclimatize when they get to a new location at altitude, before performing, so that their bodies can get used to the lower level of oxygen.

VISIT
A journey through the atmosphere. bit.ly/16ELMLu

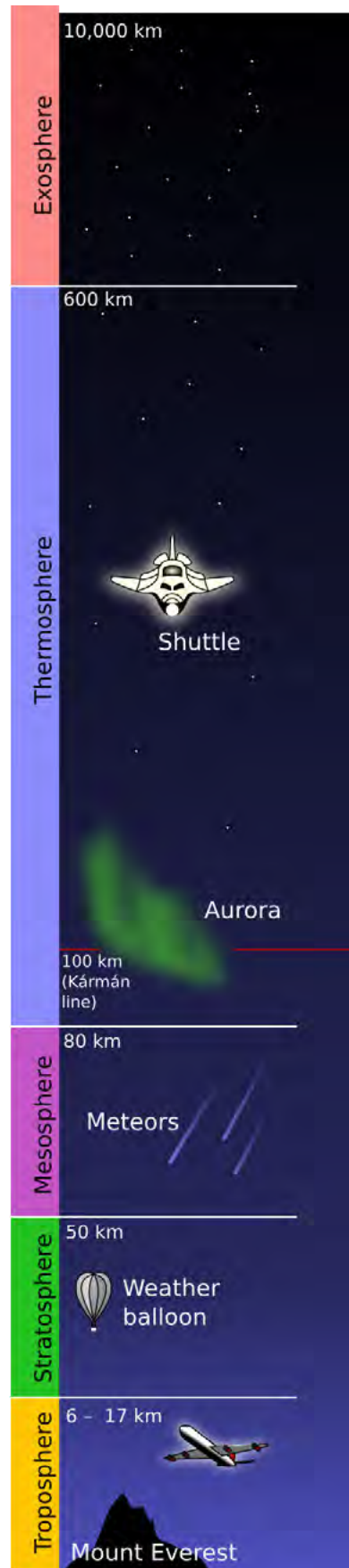

The layers of the atmosphere, and the exosphere.

The **density** of the atmosphere decreases with an increase in the height above sea level (altitude). Density is an indication of how many particles are present in a specific volume of gas. When the density is high, there are lots of gas molecules present. If the density is low, there are fewer gas molecules present. The

atmosphere is a very important part of the Earth. It keeps the planet warm and protects us from the harmful radiation of the Sun. It also ensures a healthy balance between oxygen and carbon dioxide so that life can be sustained on the planet.

The atmosphere has four main layers. We start measuring these from sea level and move towards space. The diagram alongside illustrates this. The surface of the Earth is at the bottom of the diagram, with Mount Everest drawn in. The first layer is the **troposphere**, then the **stratosphere**, the **mesosphere** and the **thermosphere**. Above the thermosphere, the atmosphere merges with outer space in the layer known as the **exosphere**.

The atmosphere is actually a very thin layer compared to the size of the Earth. It is almost like the skin of an orange, relative to the size of the orange.

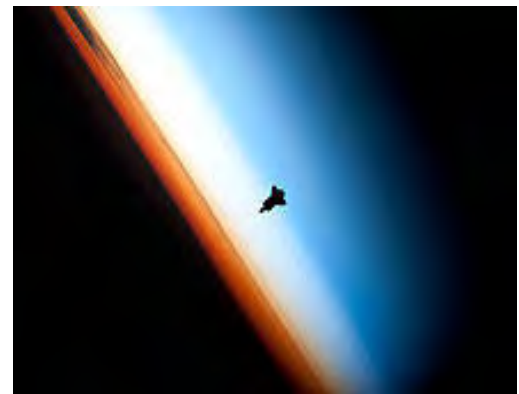

Space Shuttle Endeavour in between the stratosphere (white layer) and mesosphere (blue layer). The orange layer is the troposphere.

ACTIVITY: How thick is the atmosphere compared to the size of the Earth?

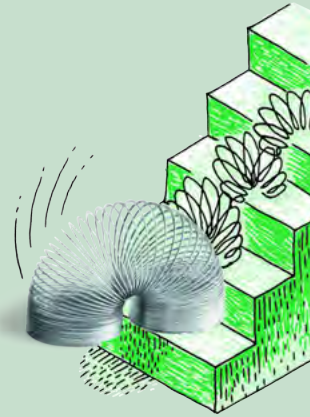

INSTRUCTIONS:

1. You need to draw a scale diagram to show how thick (or thin) the atmosphere is in comparison to the size of the Earth. Use the graph paper given below.
2. Answer the following questions to help you draw the diagram.
 - a) What is the radius of the Earth? Choose an appropriate scale and draw a circle in your notebook to represent the Earth.
 - b) How thick is the atmosphere in km? Use the same scale as above and draw the atmosphere around the Earth.
 - c) Indicate the atmosphere density gradient on your diagram.

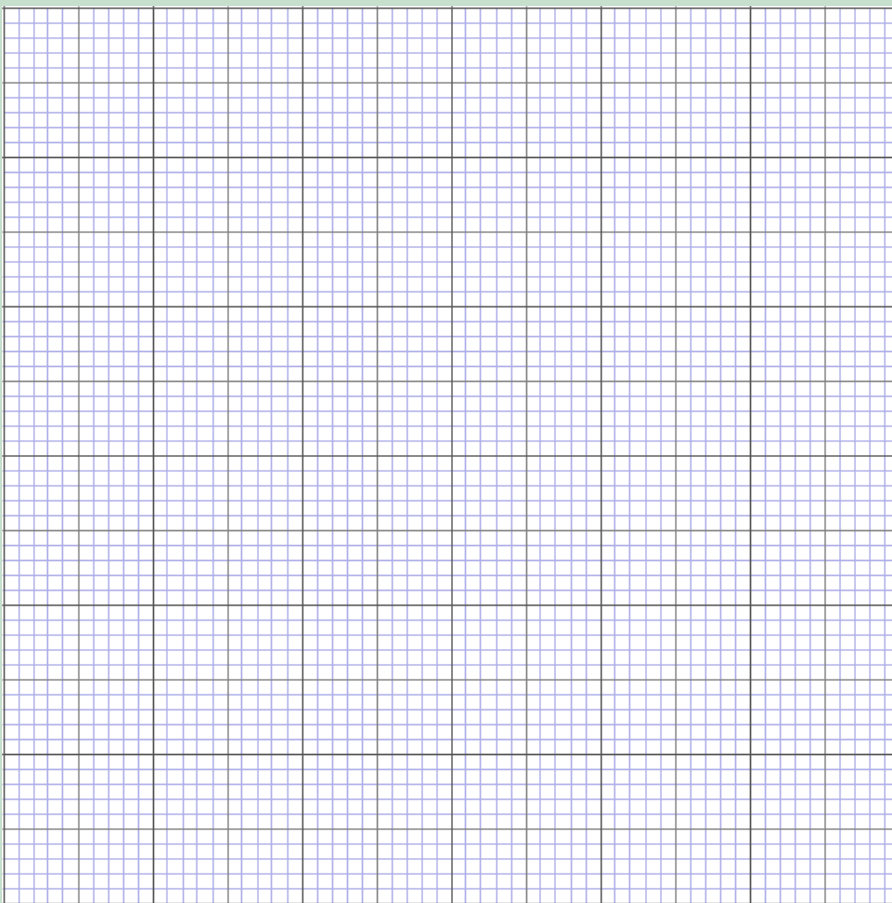

- a) 6400 km.
- b) About 480-600 km (accept any answer within this range).
- c) Learner-dependent answer.

TEACHER'S NOTE

The atmosphere is denser closer to the surface than further away. This can be indicated by using darker going to lighter colours, or using more dots and fewer dots, or any other way of indicating that the atmosphere is denser at the bottom. A scale needs to be included. A possible diagram could look like this:

Scale drawing of the Earth and the surrounding atmosphere. 1 block = 400 km.

Scale drawing showing the thickness of the atmosphere relative to the thickness of the Earth.



Each layer of the atmosphere has a different **temperature gradient**, in other words, the temperature changes gradually as you move through each layer. The following graph shows how the temperature changes as you move through the atmosphere. The layers of the atmosphere are also indicated on the graph. Temperature is on the x-axis and altitude is on the y-axis. The red line shows the change in temperature. Note that as you move further to the left on the graph it is colder, dropping far below 0 °C, and further to the right is hotter, reaching over 1000 °C.

TAKE NOTE

Altitude is a measure of height above sea level.

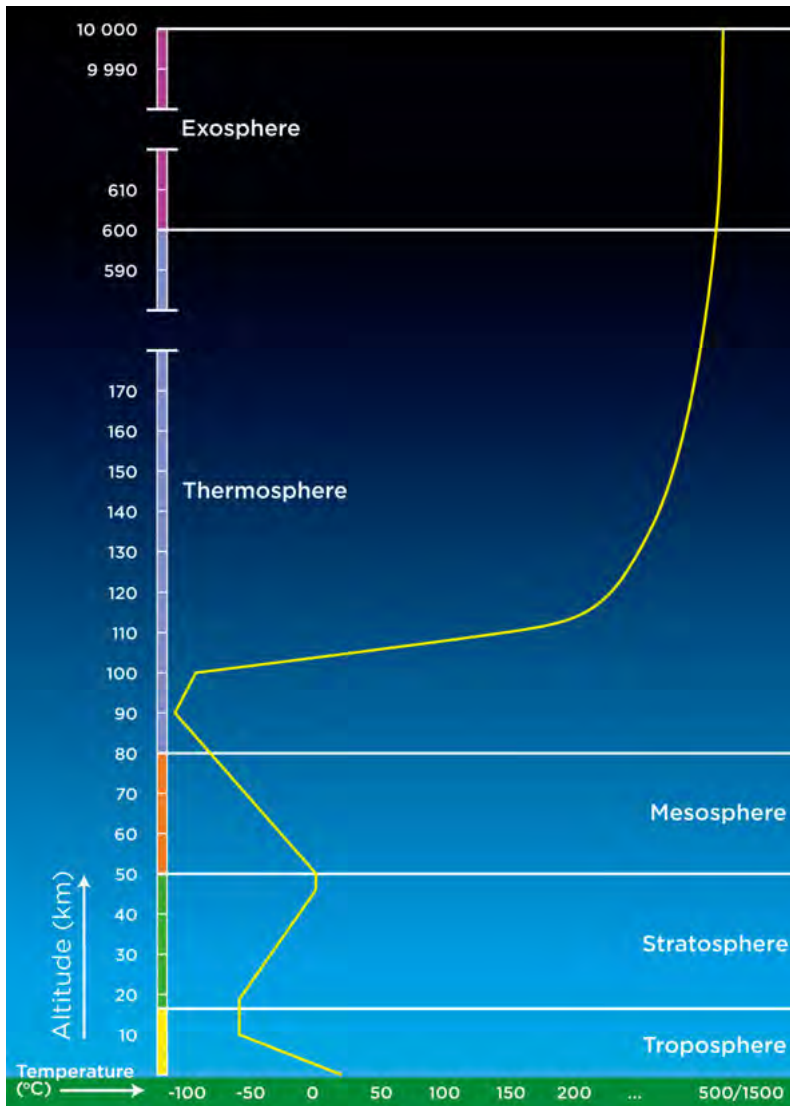

The average temperature profile of the Earth's atmosphere and the exosphere.

VISIT
Our atmosphere is escaping.
bit.ly/17TY3GR

Now let's look at each of the layers of the atmosphere.

4.2 The troposphere

TEACHER'S NOTE

The boundaries between the layers in the atmosphere are not as clear as the boundaries between liquids. The values are often given as a range and the transitions take place in zones called pauses, for example the tropopause is the zone in-between the troposphere and the stratosphere.

The troposphere is the lowest layer in the atmosphere. It stretches from sea level up to about 9 km at the poles and 17 km at the equator. Due to the Earth's rotation, the atmosphere is thicker at the equator than at the poles. On average it is about 12 km thick.

The density of air decreases as you move further away from the surface of the Earth. The first two layers of the atmosphere contain most of the mass of the

atmosphere. The bottom part of the troposphere has a high enough density for us to breathe and is the layer of the atmosphere in which we live.



TAKE NOTE

Troposphere comes from the Greek word *tropein*, meaning to change, circulate or mix.

Shown here is the orange-coloured troposphere, the lowest and most dense portion of the Earth's atmosphere above the Earth's surface, with the Moon above.

The air in the troposphere is in constant motion. As it is warmed by the Earth, the warm air moves away and gets replaced by cooler air which travels in convection currents. This is the basis for cloud formation and weather patterns. All the Earth's weather systems take place close to the Earth in the troposphere.



Cloud formations typical of a tropical cyclone. This one was photographed approaching the southeastern coast of Brazil.



Clouds forming in the troposphere.

The temperature in the troposphere decreases with altitude - the further you move away from the surface, the colder it becomes. The temperature decreases about $6,4^{\circ}\text{C}$ for every kilometre increase in altitude. In the following activity you will investigate the change in temperature as height above sea level increases.

ACTIVITY: Drawing a graph of the temperature gradient in the troposphere

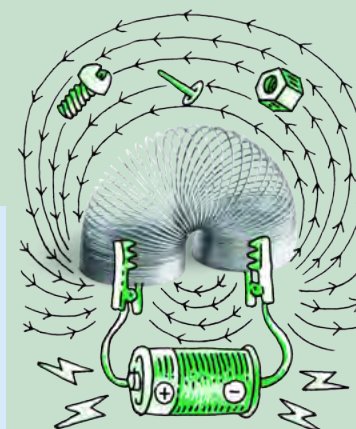

TEACHER'S NOTE

If you would like to assess learners' tables and graphs you can use Assessment Rubric 3 and 4 to do so. As an extension you could get the learners to draw a similar graph for the change in pressure as you move through the troposphere. They will have to first find out what the pressure gradient is in the atmosphere.

INSTRUCTIONS:

1. Using the information in the previous text, set up your own table displaying the temperature change in the troposphere from 0 - 12 km.
2. Then draw a neat, accurate graph of this data.
3. Assume that the average temperature on the surface of the Earth is 16°C.
4. Choose an appropriate scale for the x- and y-axes of your graph.
5. Label the axes and give the graph a heading.

Use the following space to draw a table for your data.

TEACHER'S NOTE

An example table is given below:

Change in temperature as altitude increases in the troposphere

Altitude (m)	Temperature (°C)
0	16
1000	9.6
2000	3.2
3000	-3.2
4000	-9.6
5000	-16
6000	-22.4
7000	-28.8
8000	-35.2
9000	-41.6
10 000	-48
11 000	-54.4
12 000	-60.8

Use the following space to draw your graph.

TEACHER'S NOTE

An example graph is given below.

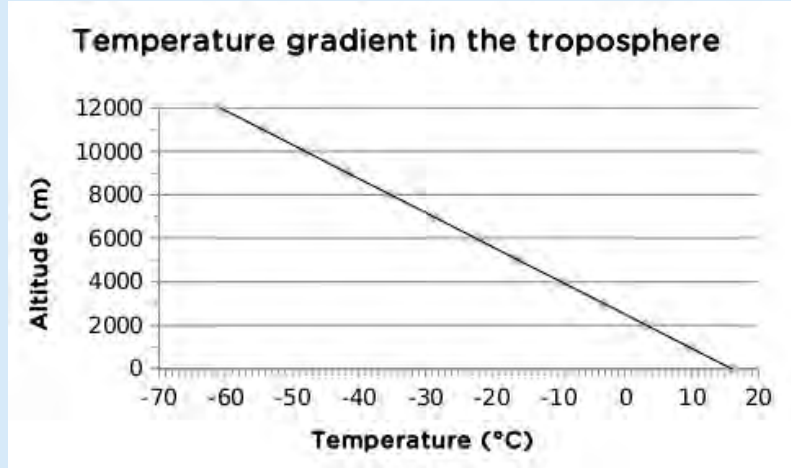

An alternative graph with the altitude on the x-axis is shown below:

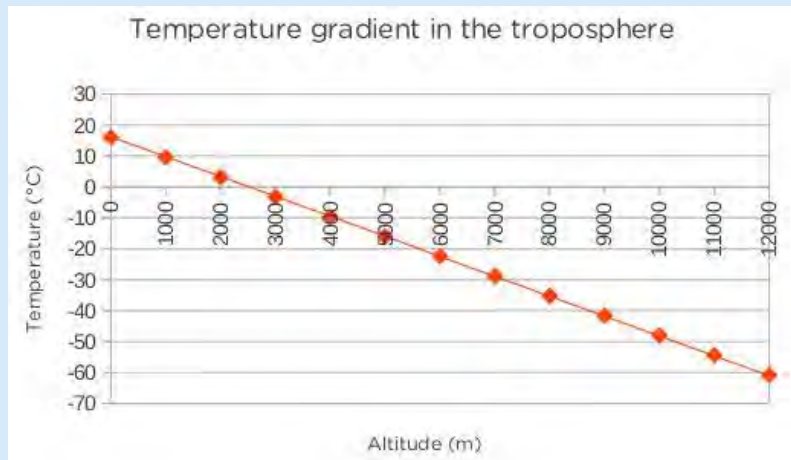

VISIT
Layers of the atmosphere.
bit.ly/1aBLpjN

The temperature in the troposphere decreases steadily until it reaches about -60°C at about 10-12 km above sea level. The temperature here stabilises before it increases again. This is the transition zone between the troposphere and the stratosphere. This layer forms an invisible barrier which prevents the warmer moist air from escaping from the troposphere. Beyond this region air does not circulate much and weather patterns are not found any more.

4.3 The stratosphere

The stratosphere is the layer above the troposphere. It stretches from 12 km to 50 km above the surface of the Earth. 90% of the mass of the atmosphere is found in the troposphere and the stratosphere.

Aeroplanes fly in the lower stratosphere because the air is much more stable than in the troposphere. The density of the air in the stratosphere is very low and decreases with altitude.

Scientists use **weather balloons** to gather information on the temperature and pressure as they move up from the Earth's surface to the stratosphere. A weather balloons carries a small device, called a radiosonde, which sends back information on atmospheric pressure, temperature, humidity and wind speed.



A weather balloon being released from a US Navy ship.



A photograph taken by a weather balloon 30 km above Earth in the stratosphere.

VISIT

Footage from a weather balloon. bit.ly/1dEz4yt

Weather balloons are filled with helium or hydrogen and rise higher and higher into the atmosphere. Do you think they continue rising up for ever? What do you think happens to the balloon as it increases in altitude? Hint: Think of what happens to the gas inside the balloon as the altitude increases. Discuss this with your class and take some notes below.

TEACHER'S NOTE

Discuss this with your class as it provides a good opportunity to revise some of the concepts learned in Gr 8 on the particle model of matter, as well as extend this knowledge. As the weather balloon rises higher and higher in the atmosphere, the pressure decreases. The volume of gas inside the balloon therefore increases and the balloon expands. Eventually it gets to a point where the balloon material cannot stretch anymore and the balloon bursts. This usually happens between 25 and 30 km above the Earth's surface. You can also explain to learners that the radiosonde has a small parachute attached to it which opens up when it begins to fall back to Earth. This is to slow its fall so that it does not crash down and cause damage to someone or something. Also, these sensors are never retrieved. Scientists don't need to retrieve them to get the information back because data will have been sent by radio signals.

Ozone gas (O_3) is found in the stratosphere. Ozone gas is made up of ozone molecules. Each molecule consists of three oxygen atoms. Ozone plays an important role in absorbing harmful UV rays from the Sun by forming, breaking down and reforming ozone molecules over and over again. When UV light

reaches the Earth, it can cause cancer, affect plant growth, and the life cycles of species.

What happens to ozone in the atmosphere?

TEACHER'S NOTE

This is extension content on what happens to ozone in the atmosphere and is not prescribed by CAPS. However, it is within the learners' capacity to understand it, given what they have learned in Matter and Materials. For more information about ozone you can visit ¹ bit.ly/17oaroh

The formation and destruction of ozone is a natural process that takes place in the stratosphere. Oxygen forms ozone, and ozone breaks apart again to form oxygen. The following diagram shows the reactions that take place.

Natural ozone production

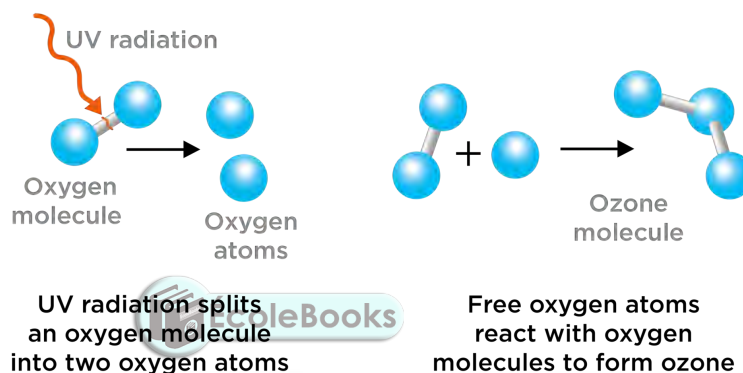

Natural ozone destruction

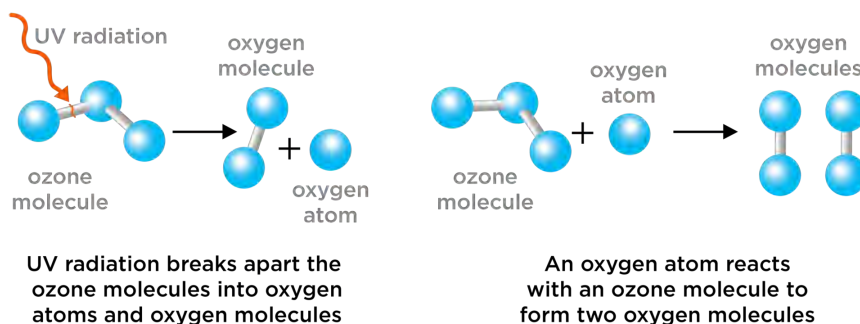

What holds the oxygen atoms together in a molecule?

TEACHER'S NOTE

A chemical bond.

What is the term given to a molecule of oxygen which consists of two atoms of the same element bonded together?

TEACHER'S NOTE

A diatomic molecule.

TAKE NOTE

Although ozone is considered a pollutant in the troposphere, in higher altitudes in the stratosphere, ozone is considered vital as it protects Earth from too much ultraviolet radiation.

VISIT

Ozone layer danger.

bit.ly/1dEzkgQ

The ozone reactions lead to the heating of the stratosphere, increasing the temperature from -60°C to about 0°C . As a result, the air becomes warmer as you move further away from the Earth in the stratosphere.

The problem comes in when there are molecules present which interfere with these natural processes. Chlorofluorocarbons, or CFCs, are molecules which release chlorine atoms into the stratosphere. Chlorine atoms react with ozone, destroying it before it can absorb harmful UV rays. The following diagram shows how CFCs react with ozone.

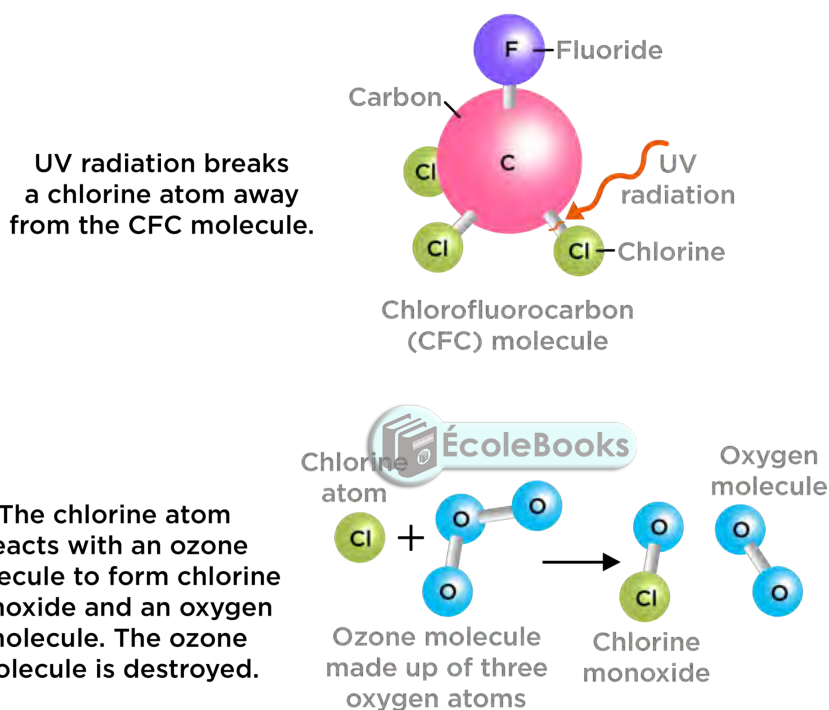

CFC's react with ozone.

CFCs used to be found in aerosols and refrigerator gas, and were given off by industrial processes. Scientists noticed that these gases interfered with ozone. This could have had a serious impact on life on Earth and the use of CFCs was banned.

VISIT

Watch a video of Felix's
jump here. bit.ly/1cmYvVB

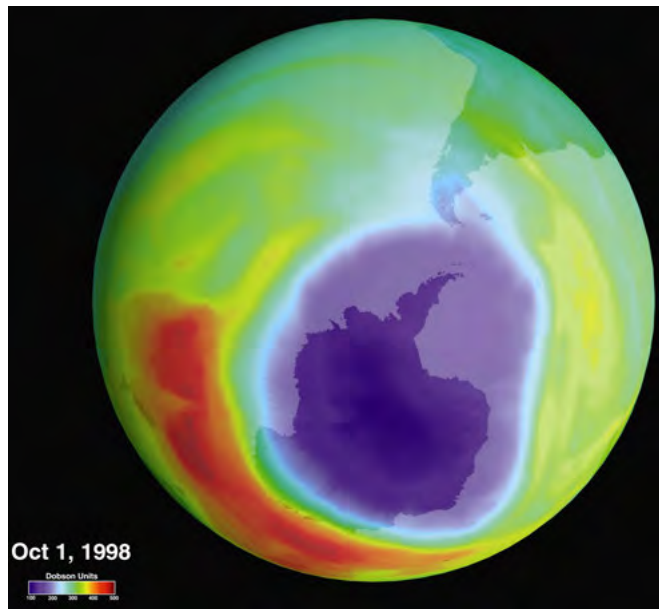

In 1985, a British scientist working in Antarctica discovered a 40 percent loss in the ozone layer over the continent. In the 1990s, this prompted a worldwide ban on CFCs. In this image, the blue/purple areas show low ozone, while the red areas indicate higher ozone levels.

4.4 The mesosphere

The mesosphere extends from around 50 km to 80 km above the Earth's surface. The atmosphere reaches its lowest temperature ($-90\text{ }^{\circ}\text{C}$) in the mesosphere. The air density is extremely low, but there is still enough air to burn up rocks and dust entering from space.



A meteor is a rock burning up in our atmosphere.

A **meteor** is a rock that enters the atmosphere from space. It travels at extremely high speed, up to 30 000 m/s. As a meteor enters the atmosphere, the air in front of it is compressed. The air heats up and the meteor burns up as a result of heat and friction. When we look up at the night sky, we might see a streak of light flashing for a brief moment. This is commonly called a shooting star, but is in fact a meteor burning up in the mesosphere.

Most meteors are fairly small and burn up completely while whizzing through the mesosphere. Some of the larger, denser meteors can reach the Earth and are then called **meteorites**. When the meteorite strikes the ground, it kicks up dust and soil and leaves an impact crater on the Earth's surface. The size of the

crater depends on the size, density and speed of the meteorite.

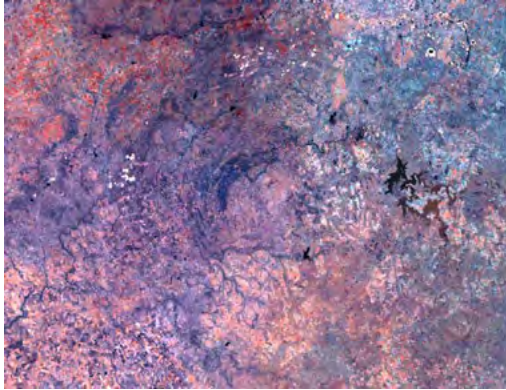

The impact crater at Vredefort in South Africa has a diameter of 300 km, and nearly fills the complete aerial photograph shown here.



The Tswaing Crater, just north of Pretoria, is 1.1 km wide and formed as the result of a meteorite impact about 200 000 years ago.

VISIT

Watch the meteor shower over Johannesburg four years ago bit.ly/1hnulRR and short clips of the meteor show that hit Russia in early 2013 bit.ly/1cmYDUV

4.5 The thermosphere

The thermosphere is the layer of the atmosphere from 80 km upwards. The density of the air is extremely low. The further away you move from the Earth, the less dense the concentration of molecules becomes until the atmosphere becomes space.

Most satellites that we depend on every day are in Low Earth Orbit (LEO), orbiting the Earth at an altitude between 160 km and 2,000 km. The International Space Station (ISS) is situated at 370 km in the thermosphere. This is an international facility in space that is used for research purposes.



The International Space Station orbits the Earth in the thermosphere

The temperature in the thermosphere increases from -90°C to as high as 1500°C . The thermosphere is very sensitive to an increase in energy and a small change in energy results in a high temperature increase. At times of increased solar activity, the temperature can easily increase up to 1500°C . However, the

thermosphere will feel cold as there are few particles present to collide with our skin and transfer enough energy for us to feel the heat.

High energy light (for example, UV light) can cause atoms or molecules to lose electrons, forming ions. The region where this takes place is called the **ionosphere**. The ionosphere is found mainly in the thermosphere. The Sun also gives off charged particles (the solar wind), which can enter the Earth's atmosphere (mostly near the poles) and react with the ions and electrons in the ionosphere, causing a phenomenon called the **aurora**. It is a colourful display of light in the sky at the poles. In the northern hemisphere, it is called the **northern lights** or **aurora borealis**, and the **southern lights** or **aurora australis** in the southern hemisphere.

The ionosphere reflects longer wavelength radio waves, for example the radio waves we use for radio and surface-broadcast television (not satellite television), allowing the signal to be broadcast over a larger distance. The ions in the ionosphere also absorb ultraviolet radiation and X-rays.

The region beyond the thermosphere is called the **exosphere**. This layer has very few molecules and extends into space.



Sunset from the International Space Station. The troposphere is the deep orange and yellow layer. Several dark clouds are visible within this layer. The pink white layer above is the stratosphere. Above the stratosphere, blue layers show the mesosphere, thermosphere (dark blue) and exosphere (very dark blue), until it gradually fades to the blackness of outer space.

VISIT

You can see the ISS in the sky if you know where to look. The following link will give you the locations.

bit.ly/1dEzKDS

ACTIVITY: How thick are the layers of the atmosphere?

In this activity you will build a model to represent the different layers of the atmosphere. In addition to the model, you need to draw an accurate diagram in your workbook to represent the thickness of each layer. Use a ruler to draw an accurate scale diagram.



TEACHER'S NOTE

This activity demonstrates the relative thickness of the layers of the atmosphere. Learners might not realise how thin the troposphere, the layer in which we live, is compared to the rest of the atmosphere. After this activity they should have a better comprehension of the thickness of the layers of the atmosphere relative to each other.

MATERIALS:

- large measuring cylinder or tall drinking glass
- corn kernels (popcorn)
- samp
- dried peas
- beans



TEACHER'S NOTE

Alternative materials are different types of dry breakfast cereals, or different shapes of pasta (shells, screws, macaroni, gnocchi, etc. Any tall, thin transparent container can be used.)

INSTRUCTIONS:

1. Add a 0,5 cm layer of dried split peas to represent the troposphere (1 layer of peas thick).
2. Add a 1,5 cm layer of corn kernels on top of the peas to represent the stratosphere.

3. Add a 1,5 cm layer of samp on top of the corn kernels to represent the mesosphere.
4. Add a 24 cm layer of beans on top of the samp to represent the thermosphere.

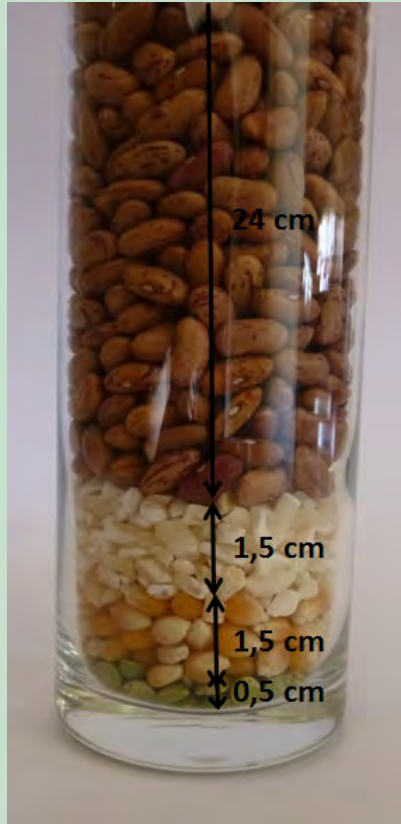

Your column should look something like this.

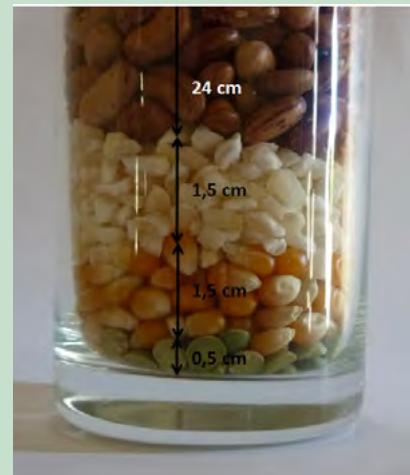

A close-up photograph of the layers.

You will notice that the area where the two layers meet is not always clear cut. The kernels might have mixed a little bit. The atmosphere is the same. There is a not a clear line separating two layers, but they mingle in the area of contact.

Table showing the heights of the layers in Earth's atmosphere and in the model

Layer	Represented by	Height of layer (km)	Height of layer (cm)
Troposphere	Dried split peas	10	0,5
Stratosphere	Corn kernels	30	1,5
Mesosphere	Samp	30	1,5
Thermosphere	Beans	480	24

QUESTIONS:

1. Draw a labelled diagram of the model using the graph paper. Include a scale. The density of the atmosphere decreases with altitude. Show this on your diagram as well.

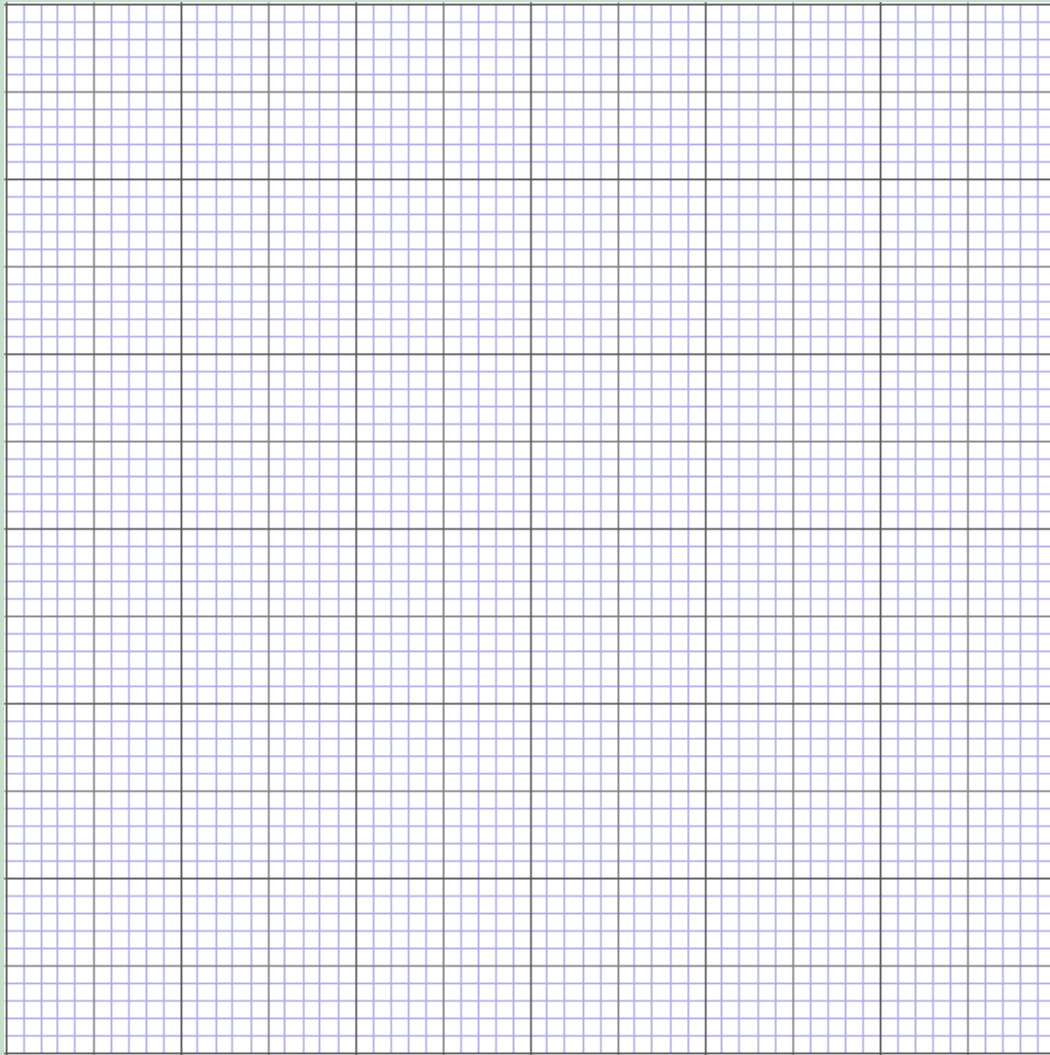

Learners can either draw a diagram here on the graph paper in their workbooks or on another piece of larger paper. If they draw it here in their workbooks, they will not be able to draw the diagram using the same scale as the model, as there is not enough space to draw a diagram 27,5 cm long. They can do this on another separate piece of paper. Using the graph paper, they must indicate what scale they have used, for example, 1 block or cm represents 20 km, etc.

To indicate density, learners can use darker and lighter colours or use lots of dots at the bottom and gradually fewer dots higher up.

2. What atmospheric layers are represented by the different grains in the model?
This answer depends on the model made.
Peas - troposphere
Corn - stratosphere
Samp - mesosphere
Beans - thermosphere
3. In the model in the activity, how many kilometers does 1 cm represent?
This can be calculated, for example: $10 \text{ km} / 0,5 \text{ cm} = 20 \text{ km/cm}$.
4. How much thicker is the stratosphere compared to the troposphere?
It is three times thicker.
5. How much thicker is the thermosphere compared to all the other layers combined?
It is seven times thicker.
6. Where in this model would you expect to find clouds?
Troposphere
7. Where in this model would you expect to find the Drakensberg Mountains?
Troposphere
8. Where in this model would you expect to find a satellite?
Thermosphere
9. Where in this model would you expect to find meteors burning up?
Mesosphere
10. In which layer is there life? What is different about this layer?
Troposphere. It is the thinnest layer.

4.6 The greenhouse effect

You have learned a lot about greenhouse gases in Natural Sciences. In this section we will be looking at how important greenhouse gases are to sustain life on Earth.

Earth's atmosphere contains mostly (99%) nitrogen and oxygen, but a small percentage (1%) of the atmosphere contains gases like **water vapour** (H_2O), **carbon dioxide** (CO_2) and **methane** (CH_4). Carbon dioxide is a product of respiration in all organisms and also a gas given off by industrial processes and the burning of fossil fuels and vegetation. Methane is a gas, also called natural gas, which occurs in reservoirs beneath the surface of the Earth. It is also given off by decomposing plant and animal material and animals give off methane as part of their digestion. Water vapour is formed when water evaporates on Earth.

Water vapour, methane and carbon dioxide are gases which let through incoming visible light from the Sun. The incoming radiation from the Sun is absorbed by the Earth's surface and warms it. The Earth's surface emits **infrared radiation**. Infrared radiation is absorbed by the greenhouse gases and re-emitted in all directions. This increases the temperature of the Earth's surface and lower atmosphere, above what it would be without the gases, called the **greenhouse effect**. These gases are very important to regulate the Earth's temperature.

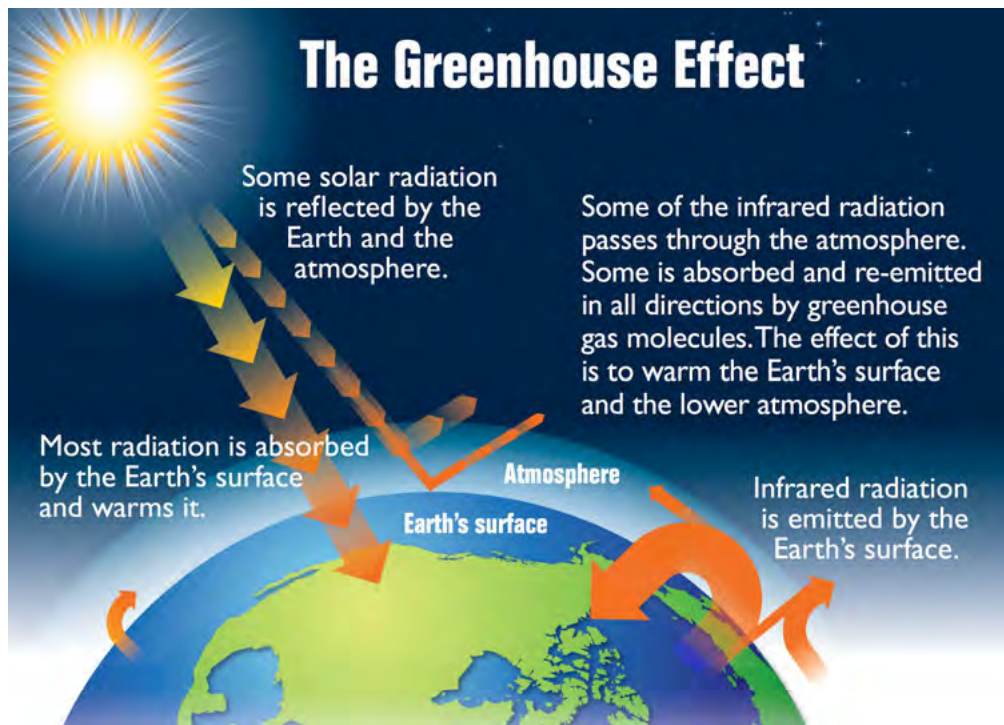

VISIT

Learn more about the greenhouse effect with this simulation. bit.ly/192V4iT

As you can see in the diagram, the radiation from the Sun is able to reach the Earth and warm it up. The energy that is given off by the Earth is trapped by the water vapour, carbon dioxide and methane. This ensures that the Earth stays warm. It is almost as if the gases form a blanket around the Earth keeping some of the heat inside. The gases are referred to as **greenhouse gases**. A greenhouse is a glass structure that is used to grow plants. The glass lets the heat of the Sun through, but then keeps the heat inside the structure so that the plants have a moderate climate in which to grow. Water vapour, carbon dioxide and methane act in the same way.

The Earth is a very unique planet due to the make-up of its atmosphere. In this chapter you have learned about the composition of the Earth's atmosphere. Let us compare the atmosphere of Earth to its neighbouring planets, Mars and Venus.

ACTIVITY: Comparing Earth, Mars and Venus



Venus, Earth and Mars.

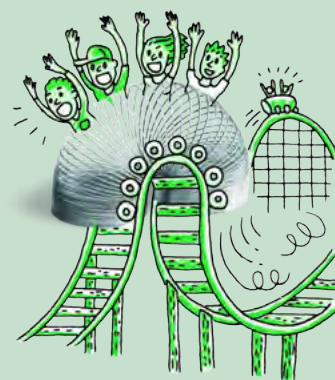

INSTRUCTIONS:

1. The table below gives information about the gases in the atmospheres of the three planets: Venus, Earth and Mars.
2. Study the table and answer the questions that follow.

Percentage of gases making up the atmospheres of Venus, Earth and Mars.

	Venus	Earth	Mars
Carbon dioxide (CO ₂)	96,5%	0,03%	95%
Nitrogen (N ₂)	3,5%	78%	2.7%
Oxygen (O ₂)	Trace	21%	0,13%
Argon (Ar)	0,007%	0,9%	1,6%
Methane (CH ₄)	0	0,002%	0

QUESTIONS:

1. Compare the data for Venus and Earth. What similarities and difference do you notice?
*Venus' atmosphere is made up of mainly carbon dioxide. Earth's atmosphere contains very little carbon dioxide.
 Earth's atmosphere is made up of mainly nitrogen and Venus has very little nitrogen.
 Earth's atmosphere contains a lot of oxygen, whereas Venus contains only trace amounts (very little).
 Argon is present at a low level for both planets.
 Venus has no methane.*
2. Compare the data for Venus and Mars. What similarities and difference do you notice?
*Venus and Mars have very similar atmospheres. Most of their atmospheres are made up of carbon dioxide, with very low levels of all the other gases.
 Neither of them contain methane.*
3. What is the biggest difference between Earth's atmosphere and the atmospheres of the other two planets?
Earth's atmosphere contains almost no carbon dioxide, but has a lot of nitrogen and oxygen, whereas the atmospheres of Mars and Venus consist primarily of carbon dioxide and a few other gases.
4. Why is the level of oxygen so much higher on Earth than on the other two planets?
Oxygen is produced by the oceans and plants on Earth. Venus and Mars have no liquid water and there is no life on the planet, so oxygen cannot be produced in large quantities.
5. Why do you think there is no methane gas on Venus and Mars?
Methane gas is produced by animals and by decomposing plant and animal matter. There is no life on Venus and Mars and nothing present on these planets which can produce methane.
6. Predict whether you think the temperature on the surface of Venus will be low or high. Give reasons for your answer.
*The temperatures will be very high. Venus has a lot of carbon dioxide which traps the heat of the Sun and makes the surface temperature high.
 Venus is closer to the Sun than the Earth is, and therefore receives more radiation.*

VISIT
 Carbon dioxide and the greenhouse effect.
bit.ly/Hcf0pe



The atmospheres of Venus and Mars are very similar. Both planets have mainly carbon dioxide in the atmosphere, and very little other gases. However, the two planets are quite different.

Venus has a very dense atmosphere which results in a high concentration of carbon dioxide on its surface. This causes an extreme greenhouse effect and very high temperatures on the surface of Venus. Venus has an average surface temperature of 462 °C. This is too high to sustain life as we know it.

Mars, on the other hand, has almost no atmosphere, so, although there is carbon dioxide present, the density is very low and almost no greenhouse effect takes place. Mars is also much further away from the Sun. It is a very cold planet, with an average temperature of -55°C. This is too low to sustain life as we know it.

Earth has the right composition of atmospheric gases to sustain life. It has the right balance between oxygen and nitrogen so that plants and animals can breathe, and just enough carbon dioxide and methane to keep the planet warm enough so that life can be sustained. Many scientists think that it is the life on Earth that keeps the atmosphere in this perfect balance. Plants produce oxygen and re-circulate carbon dioxide on Earth. They believe that if life were to disappear from Earth, the atmosphere would become like Mars or Venus.

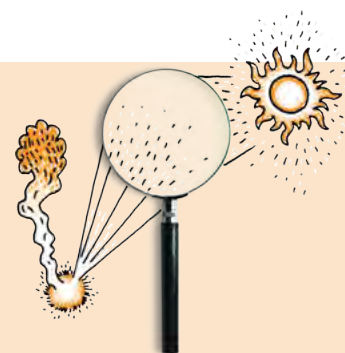

INVESTIGATION: A model of the greenhouse effect

In the greenhouse effect, carbon dioxide traps the heat of the Sun. In this investigation, you will use bottles with air and carbon dioxide, respectively, to model the greenhouse effect. You are going to investigate the following question: Does air or carbon dioxide absorb more heat?

TEACHER'S NOTE

CAPS prescribes plastic bags, we have used plastic cold drink bottles as it makes data collection easier.

You can make the holes in the lids of the bottles beforehand using a knife or by hammering a nail in through the lid. Otherwise learners will need to do this and you will need a hammer, a nail about the width of the thermometer and a wooden block to hammer into.

You can prepare and collect small bottles of carbon dioxide beforehand, otherwise learners will need to do this. To collect a bottle of carbon dioxide, add one tablespoon of bicarbonate of soda to the small bottle. Add 10-20 ml of vinegar and place the lid back on. Hold the mouth of the small bottle over the CO₂ container and pour the carbon dioxide into the large bottle. Carbon dioxide is denser than air and can therefore be poured into the large bottle. Add more vinegar when the effervescence stops. Repeat 2-3 times until the large bottle is full. If a burning match at the mouth of the bottle goes out immediately, the bottle is full.

VISIT

A greenhouse gas demonstration.

bit.ly/1f02zss

AIM: Write an aim for this investigation.

TEACHER'S NOTE

A possible answer is 'To determine whether carbon dioxide or air traps more heat.'

HYPOTHESIS: Write a hypothesis for this investigation.

TEACHER'S NOTE

Learner-dependent answer.

MATERIALS AND APPARATUS:

- two glass bottles or clear cold drink bottles with lids
- 2 thermometers
- Prestik
- heat source (two study lamps)
- vinegar
- bicarbonate of soda
- small cold drink bottle with lid

METHOD:

Set up the experiment as in the photograph.



Experimental set-up.

1. Mark one bottle as 'Air' and the other bottle as 'CO₂'.
2. If the lids do not have the thermometers in them already, prepared by your teacher, make a hole in each of the lids. You can do this using a hammer and nail and hammering the nail through the lid into a wooden block. Secure the thermometer in each lid. You can use Prestik to do this.
3. Fill the first bottle with air and secure the thermometer and close the lid tightly.
4. Fill the second bottle with carbon dioxide:
 - a) To collect a bottle of carbon dioxide, add one tablespoon of bicarbonate of soda to the small bottle.
 - b) Add 10-20 ml of vinegar and place the lid back on.
 - c) Hold the mouth of the small bottle over the large CO₂ container and pour the CO₂ collecting in the small container into the large container.

Hold the small bottle horizontal so that the vinegar does not spill into the bigger bottle, only the heavier carbon dioxide gas pours into the large container.

- d) Add more vinegar when the effervescence stops. Repeat 2-3 times until the bottle is full. If a burning match at the mouth of the bottle goes out immediately, the bottle is full.
- e) Secure the thermometer and close the lid tightly.



Pouring carbon dioxide from the small bottle into the large bottle. Your teacher will prepare the carbon dioxide for you.

- 5. Measure and record the starting temperature of both bottles.
- 6. Switch on the heat source and measure the temperature increase in both bottles. You need to decide for yourself what time increments are appropriate and record these in the table.



The CO₂ container with the light positioned to shine on it.

RESULTS:

Complete the following table.

Time (minutes)	Temperature of air bottle (°C)	Temperature of CO ₂ bottle (°C)

Represent your results by drawing a graph for each of the experiments to show how the temperature for each bottle changed over time. You need to decide what values to use for each axis. Label the axes clearly and provide a heading for each graph.

TEACHER'S NOTE

Learners should draw both graphs on the same set of axes, or if not, then both graphs should have the same scales so that the graphs can be compared,

An example graph is shown here:

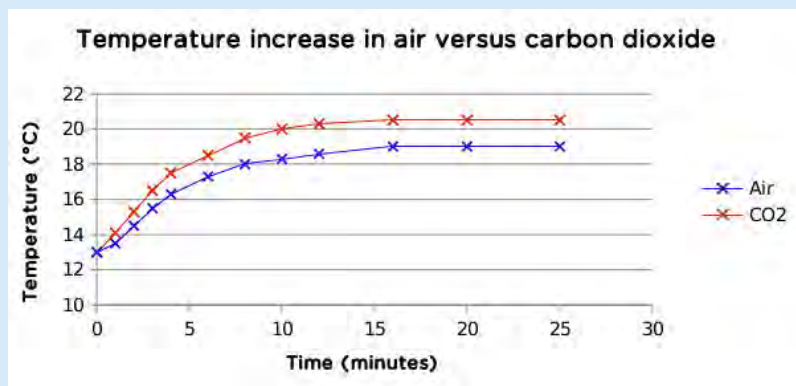

Both graphs follow a similar trend, but the carbon dioxide graph flattens out at a higher temperature. This means that carbon dioxide has trapped more heat than air. Although it is only a small difference (1,5°C), it is significant. The temperature change takes place quite quickly (within 20 minutes) and can easily be demonstrated within one lesson.

What have you observed?

TEACHER'S NOTE

The temperature in the carbon dioxide bottle increased more than in the bottle with air.

In both cases the temperature increased quickly, and then stabilised from about 15 minutes.

CONCLUSION:

What do you conclude for your experiment?

VISIT

A demonstration of this experiment can be found here. bit.ly/16EMVTI

TEACHER'S NOTE

The carbon dioxide has trapped more heat than the air.

Extension investigation: What factors make the temperature of the atmosphere increase faster?

TEACHER'S NOTE

This is an optional extension in which learners must design their own experiment to answer one of the following questions. They can then write up an experimental report. You can use Assessment Rubric 2 to assess learners' work.

Design your own investigation to answer one or more of the following questions. Use the experiment above to guide your experimental set-up.

1. Does dark soil make the temperature increase faster?
2. Does water vapour make the temperature increase faster?
3. Does the thickness of the layer of gases make the temperature increase faster?
4. Does the presence of dust/aerosols make the temperature increase faster?
5. Does the distance of the Sun make the temperature increase faster?

Global warming

What do you think will happen if the levels of carbon dioxide and other greenhouse gases increase? Think about what you discovered in the last investigation and look at the diagram of the greenhouse effect again. Write your answer below.

TEACHER'S NOTE

Learners should have seen from the last investigation that if the levels of carbon dioxide and other greenhouse gases increase in the atmosphere, then the temperature will increase as greenhouse gases trap more heat.

VISIT

Climate change.
bit.ly/1diB3pE

If there are more greenhouse gases in the atmosphere, more ultraviolet radiation will be trapped and the Earth will heat up. This will result in more of the polar ice melting than usual. Even a one degree difference in the average temperature has an effect on the melting of polar ice. If more ice than usual melts, the water levels in the oceans will rise and low-lying areas could flood.

A change in the temperature will also result in a change in weather patterns. More rain will fall in some areas, and less in others. If this change is permanent, it is called **climate change**, and if it occurs on a worldwide scale it is called global climate change, which is what is being discussed here.

Global warming affects weather patterns which in turn has a knock-on effect on agriculture and food production. This has an impact on food production and can lead to food shortage for humans and animals. Long term climate change can lead to the extinction of plants and animals, which are unable to adapt to changed conditions.

The levels of greenhouse gases vary naturally over time. A question that scientists often ask is whether the concentration of greenhouse gases is rising more than it would naturally as a result of human activities? How do you think this can be investigated?

Since the industrial revolution humans have burned more fossil fuels than ever before. Human activities have resulted in the increase of carbon dioxide emissions over time. Carbon dioxide is therefore the main greenhouse gas under discussion amongst scientists and environmentalist. The following investigation will look at the levels of carbon dioxide over thousands of years.



INVESTIGATION: Ice core analysis

Carbon dioxide is trapped in the ice which forms at the poles. As the ice is compacted and becomes thicker over thousands of years, the carbon dioxide remains trapped. The levels of carbon dioxide in ice can be determined by analysing the ice cores. A research team in Antarctica drilled an ice core containing ice from 160 000 years ago. They analysed the ice for carbon dioxide and presented their data in the following table.

TAKE NOTE

An **ice core** is a core sample from the accumulation of snow and ice over many years that have recrystallized and have trapped air bubbles from previous time periods.

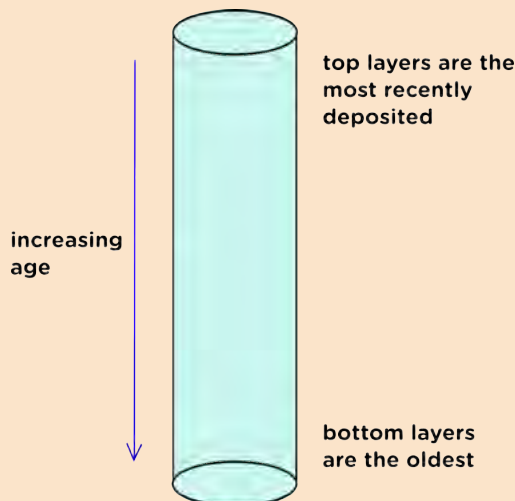

Ice cores trap carbon dioxide over time periods.



Drilling through the ice to obtain ice cores.



Sawing through the ice core to obtain samples for analysis.

Results from the ice core analysis.

Number of years ago	CO ₂ levels (ppm)
160 000	190
150 000	205
140 000	240
130 000	280
120 000	278
110 000	240
100 000	225
90 000	230
80 000	220
70 000	250
60 000	190
50 000	220
40 000	180
30 000	225
20 000	200
10 000	260
8160	280
0	387

TAKE NOTE

ppm is short for for 'parts per million'.

INVESTIGATIVE QUESTION: Write down an investigative question for this study.

TEACHER'S NOTE

How has the level of carbon dioxide in the atmosphere changed over the past 160 000 years?

ANALYSIS:

1. Draw an accurate graph to represent your data. You need to choose your own set of axes, and label them appropriately.

An example of the graph that learners produce is shown here:

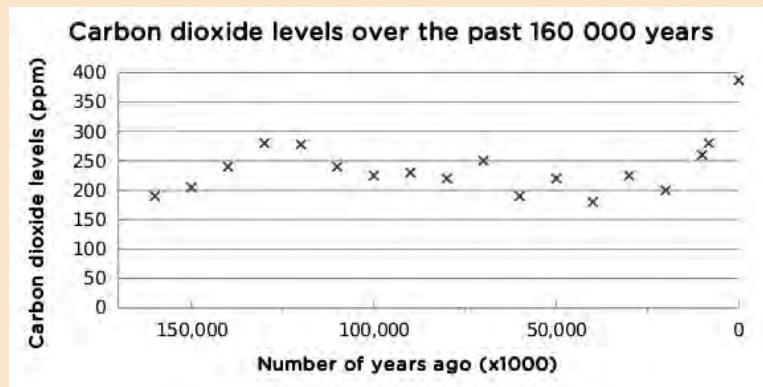

2. What is the link between the levels of CO₂, core ice and global warming?
Pockets of CO₂ are trapped in the ice. These pockets provide a record of CO₂ levels in the air atmosphere at that time. When we analyse ice from 160 000 ago, we can determine the level of CO₂ present in the atmosphere at that time. Higher levels of CO₂ means that the greenhouse effect is stronger and the Earth heats up more.

CONCLUSION:

1. Write down a conclusion for this investigation.
The levels of CO₂ have risen/doubled over the past 160 000 years.
2. What is the impact of global warming on the planet?
Increase in ocean temperatures, ice caps melting, increase in sea level, change in weather patterns, change in crop production, possible food scarcity/hunger, some areas become wetter, others dryer, animal and plant

VISIT

Could global warming, a problem here on Earth, be the solution to making Mars a habitable planet?

bit.ly/1diBqjT

SUMMARY:

Key Concepts

- The layer of gases around the Earth is called the atmosphere.
- The density of the gas molecules decreases as the distance from the Earth increases - the further away from the Earth you travel, the fewer gas molecules there are.
- The atmosphere can be divided into different layers - the troposphere, stratosphere, mesosphere and thermosphere.
- The exosphere is the uppermost layer directly above the thermosphere, where the gases thin out and the atmosphere merges with space. It is considered part of outer space.
- The troposphere is the densest layer, has the highest air pressure and is closest to the surface of the Earth. It is on average about 12 km thick and temperature decreases with altitude.
- The stratosphere stretches from 12 - 50 km and contains the ozone layer. Aeroplanes fly in this layer because the air is more stable. Temperature increases with altitude, from -60°C to 0°C .
- The mesosphere stretches between 50 - 80 km. The air is very thin. Meteorites usually burn up in the mesosphere. Temperature decreases with altitude from 0°C to -90°C .
- The thermosphere stretches up to 480 - 600 km. It absorbs ultraviolet light and X-rays. Temperature increases with altitude and can reach 1500°C .
- The ionosphere is the layer where molecules are ionised by the Sun's ultraviolet light. Radio waves can be transmitted and reflected due to the ionised layer.
- The greenhouse effect is a natural phenomenon - it warms the atmosphere sufficiently to sustain life.
- Greenhouse gases trap the re-radiation from Earth's surface and reflect it back to the Earth (like inside a greenhouse).
- The most common greenhouse gases are carbon dioxide, water vapour and methane.
- An increase in greenhouse gases leads to global warming.
- Global warming is an increase in the average temperature of the atmosphere.
- Global warming is a potentially life threatening situation on Earth. It can lead to climate change, rising sea levels, food shortages and the extinction of organisms on Earth.

Concept Map

Through the past 2-3 years you have come across concept maps in Natural Sciences. Use what you know about concept maps and design a map for this chapter. You must add terms and examples to the list. Remember to use linking words between concepts, and arrows to indicate the direction in which information is read. Plan your concept map on rough paper first before drawing the final one into your workbook.



Use the following terms to help you with your map:

- atmosphere
- layers
- mesosphere
- thermosphere
- troposphere
- stratosphere
- weather
- ozone
- satellites
- radio waves
- global warming
- greenhouse gases
- greenhouse effect
- oxygen
- carbon dioxide
- water vapour

TEACHER'S NOTE

It is important that learners complete this concept map to consolidate what they have learned. They can either do it as a homework exercise or if enough time is available, a whole period can be dedicated to this activity. Learners have been exposed to many concept maps up until now and have had to make their own from scratch for some of the smaller chapters. Learners now have to put these skills into practice for a more complex concept map. This will be good preparation for learners' examinations. There are no right and wrong answers for the concept map. An example concept map is provided here. If learners are battling, you could use this following map as a guide and with the class, draw a concept map on the board. However, do not just draw it up for learners to copy down. Learners must be actively involved in the construction. You may also come up with alternative ways of presenting the concepts.

Atmosphere

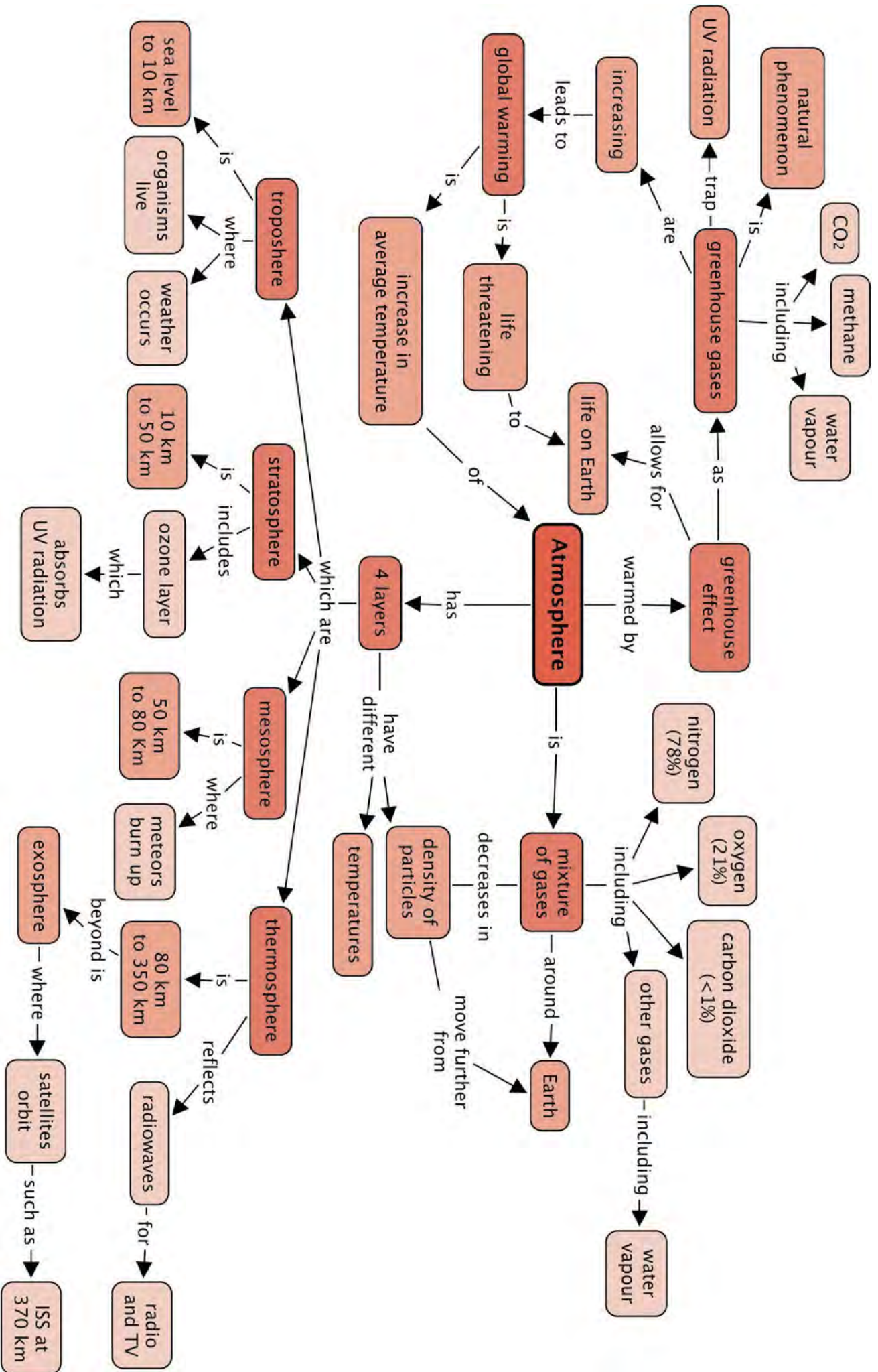

REVISION:

1. The following graph shows the variation in temperature as you move further away from the Earth. Study it and answer the questions that follow.

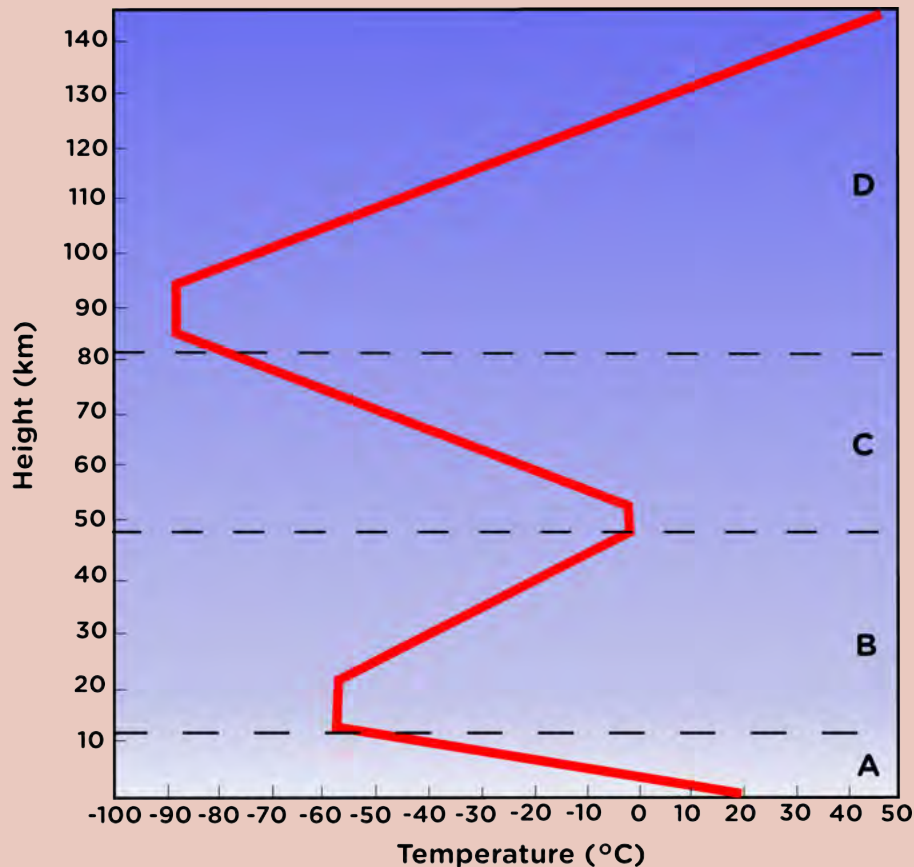

- Give labels for A-D, the layers of the atmosphere. [4 marks]
 - Describe the temperature change in each of the layers. [4 marks]
 - Explain why the temperature changes as you move further away from the Earth in Layer A? [2 marks]
 - In which layer is the density of gas the highest? Give a reason for your answer. [2 marks]
 - In which layer(s) can life survive? Give two reasons for your answer. [3 marks]
 - In which layer are satellites found? Write only A, B, C or D. [1 mark]
 - In which layer are meteors found? Write only A, B, C or D. [1 mark]
 - In which layer radio waves reflected? Write only A, B, C or D. [1 mark]
 - In which layer is weather observed? Write only A, B, C or D. [1 mark]
 - In which layer is the aurora found? Write only A, B, C or D. [1 mark]
 - In which layer do jet aeroplanes travel? Write only A, B, C or D. [1 mark]
 - In which layer are lightning and storms found? Write only A, B, C or D. [1 mark]
 - In which layer is ozone found? Write only A, B, C or D. [1 mark]
- a) *A - troposphere*
 B - stratosphere
 C - mesosphere
 D - thermosphere

- b) A - The temperature decreases with altitude from about 16°C to -60°C.
 B - The temperature increases with altitude from -60°C to 0°C.
 C - The temperature decreases with altitude from 0°C to -90°C.
 D - The temperature increases with altitude from -90°C to 1000°C.
- c) The troposphere is heated mainly through radiation of the Sun's energy by the Earth. The further you move away from the Earth, the less radiation energy there is to heat the atmosphere. Temperature will therefore decrease with altitude.
- d) The troposphere because it is the closest to the Earth and the Earth's gravity pulls the gases in the atmosphere towards the surface.
- e) The troposphere. It is warm enough and has enough oxygen for respiration. At this level, life is also protected from UV radiation.
- f) D
- g) C
- h) D
- i) A
- j) D
- k) B
- l) A
- m) B

2. Venus and Mars contains equal amounts of carbon dioxide, yet the temperature on the surfaces of these two planets are very different. Explain why. [4 marks]

Venus is closer to the Sun. Both have CO₂, but Venus' atmosphere is much denser. The greenhouse effect is much more dominant, resulting in a much hotter surface temperature. Mars has lots of CO₂, but it is not very dense and therefore the greenhouse effect is not observed.

3. Earth is the only planet that we know of that sustains life. What makes Earth's atmosphere suitable to sustain life? [2 marks]

Earth has enough oxygen and not a lot of CO₂. There are just enough greenhouse gases to ensure that the Earth is kept warm enough. It has just the right balance between CO₂ and oxygen/other gases.

4. Scientific evidence seems to point to the fact that carbon dioxide levels have increased steadily over the past 200 years.

- a) Why would the levels of carbon dioxide have been increasing over the past 200 years? [2 marks]
 - b) What is global warming? [1 mark]
 - c) What are the long term effects of an increase in carbon dioxide on life on Earth? [4 marks]
- a) Industries, human activities, burning of fossil fuels, more cars/vehicles (any two).*
- b) It is the gradual increase in the temperature of the Earth's atmosphere.*
- c) Higher levels of CO₂ means that the greenhouse effect will increase and temperatures on Earth will rise. If this continues over a long time, ice will melt, water levels will rise, coastlines will change, weather patterns will be influenced, crop production will be affected, and it could lead to the extinction of animal and plant species that are unable to adapt.*

Total [36 marks]



Curious? Unlock more possibilities with this key.



TEACHER'S NOTE**Chapter overview**

1 week

In Grades 6 and 8 learners covered material regarding the solar system including the Sun. In Grade 7, they focused on the system which includes the Sun, Earth and Moon. Learners should be familiar with the fact that the Sun is a star and produces heat and light (energy) via nuclear reactions. In this chapter the focus is on the life cycle of stars, including how they are born and die. The exact evolution that a star follows depends on the initial mass of the star. The Sun's evolution is presented as an example. The main aims of this chapter are to ensure that learners understand the following:

- stars are born in vast clouds of gas and dust
- stars spend most of their lives on the *main sequence* fusing hydrogen gas to helium gas
- stars eventually swell up to form a red giant star
- stars like the Sun end their lives as planetary nebulae and white dwarfs

Some learners may ask why stars look 'spiky' in the photographs from telescopes, but in the diagrams shown here, they are presented as spheres. Watch this video to find out and explain to your learners: bit.ly/16iqmkW

Do you think it is important to teach astronomy to learners at school? Read this interesting and informative article detailing the benefits and applications of astronomy: bit.ly/17iVgpw

5.1 The birth of a star (0.5 hours)

5.2 Life of a star (1 hour)

Tasks	Skills	Recommendation
Activity: Observing Orion in the spring sky	observing	CAPS suggested

5.3 Death of a star (1.5 hours)

Tasks	Skills	Recommendation
Activity: Life cycle of a Sun-like star	observing, investigating	Suggested
Activity: The life cycle of the Sun	observing, writing	Suggested
Activity: Flow diagram poster showing the lifecycle of a Sun-like star	writing, drawing, sequencing	CAPS suggested

A good way to introduce the topic of stellar evolution is to start by asking learners how long they think stars last. Many will answer forever. Many people are unaware that, like humans, stars are born, live their lives and then die. You can also ask them what is meant by 'living' when referring to a star, after all,

stars do not perform the seven life processes, as taught in Life and Living. Astronomers generally consider stars that are undergoing nuclear reactions in their cores to be living stars.

Stars are also compared in terms of relative concepts, such as:

- young and old
- cool and hot
- how big they are
- how massive they are (the mass is important in terms of looking at how stars die)

KEY QUESTIONS:

- Where are stars born?
- Can we talk about a star as 'living'?
- How long do stars like the Sun live?
- How do stars spend most of their life?
- Why are stars different colours?
- How do stars die?

Stars do not live forever, just like people. Stars are born, live their lives, changing or *evolving* as they age, and eventually they die. Often stars do this in a much more spectacular way than humans do!

Scientists speak of **stellar evolution** when talking about the birth, life and death of stars. The lifetime of individual stars is way too long for humans to observe the evolution of a single star, so how do scientists study stellar evolution? This is possible as there are so many stars in our galaxy, so we can see lots of them at different stages of their lives. In this way, astronomers can build up an overall picture of the process of stellar evolution. In this chapter you will discover how stars are born, how they evolve, and how they die.

5.1 The birth of a star

TEACHER'S NOTE

In this section learners will discover that stars are born in giant clouds of dust and gas, called nebulae, in space. In order to understand how collapsing gas clouds heat up to eventually form stars, learners need to understand that compressing a gas heats it up and that allowing a gas to expand cools it down. If they are unfamiliar with this concept a good analogy is to think about over-inflating a bicycle tyre (without bursting it). You could demonstrate this in class by getting learners to slightly over-inflate a tyre. They will find that the pump and tyre get hot!

In the case of inflating a tyre, you are forcing more and more molecules into a given volume (assuming that the tyre is now at full capacity). So you are compressing or squeezing the gas. Each molecule has a certain amount of kinetic energy. As more molecules are forced in by the pump, the air in the tyre is compressed and the total thermal energy increases because there are more

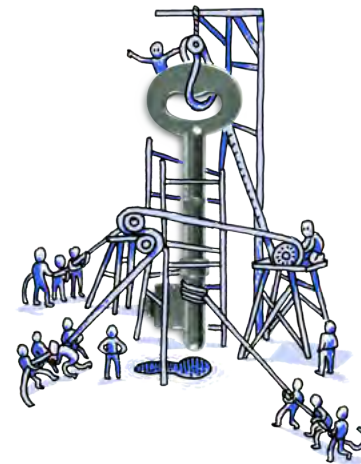

VISIT

How far is a light year?

bit.ly/HpYFOh

molecules colliding inside the tyre. As more particles are contained in the same volume, the air's temperature in the tyre increases. As you deflate the tyre, you allow the gas to expand, the molecules are more spread out. There is then less thermal energy and so the temperature decreases. You could let students feel the air as it is released from the tyre - it should be colder than the ambient air as it is rapidly expanding as it escapes from the tyre.

Stars are born in vast, slowly rotating, clouds of cold gas and dust called nebulae (singular **nebula**). These large clouds are enormous, they have masses somewhere between 100 thousand and two million times the mass of the Sun and their diameters range from 50 to 300 light years across.

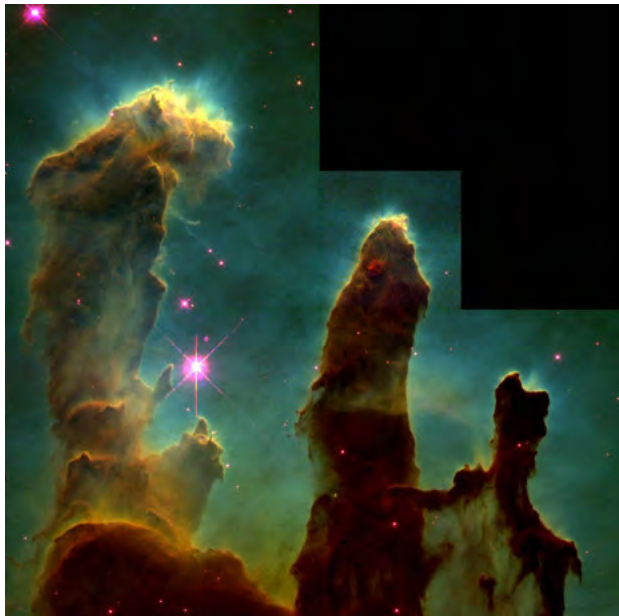

The "Pillars of creation". These giant, dense dusty clouds of hydrogen gas are vast stellar nurseries where new stars are born. (NASA)

TAKE NOTE

The collapse of a star can be triggered when the cloud is squeezed. For example if a cloud passes through a spiral arm in a galaxy it will be slowed down and compressed. This explains why lots of stars are formed in the spiral arms of galaxies.

TAKE NOTE

A light year is the **distance** that light travels in one year. Light travels extremely fast at 299 792 458 m/s. One light year is equivalent to 10 trillion kilometers.

A famous example of one of these huge clouds is the Orion nebula in the constellation of Orion. It is visible with the naked eye if the sky is dark enough. These clouds are so massive that they can collapse under their own gravity if they are disturbed.

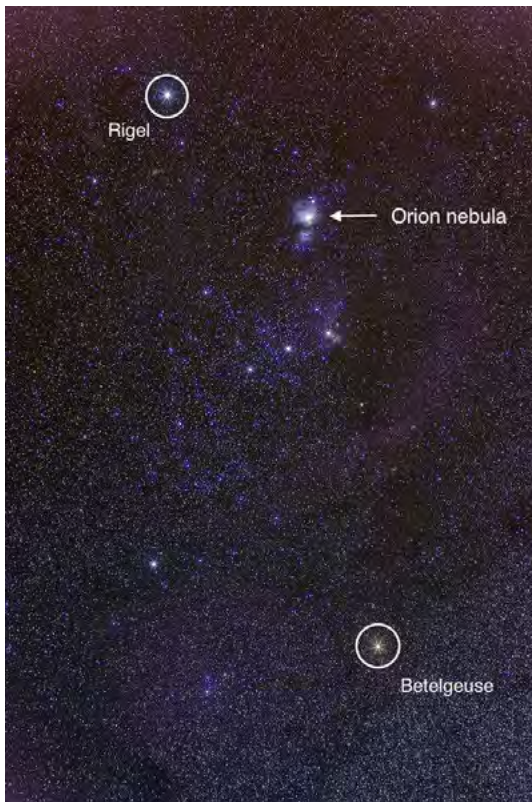

The constellation of Orion as viewed from the southern hemisphere. The Hunter Orion is "upside down" when viewed from the south and his sword lies above the three stars in his belt. The jewel in his sword which looks like a white-pink smudge is the Orion nebula.

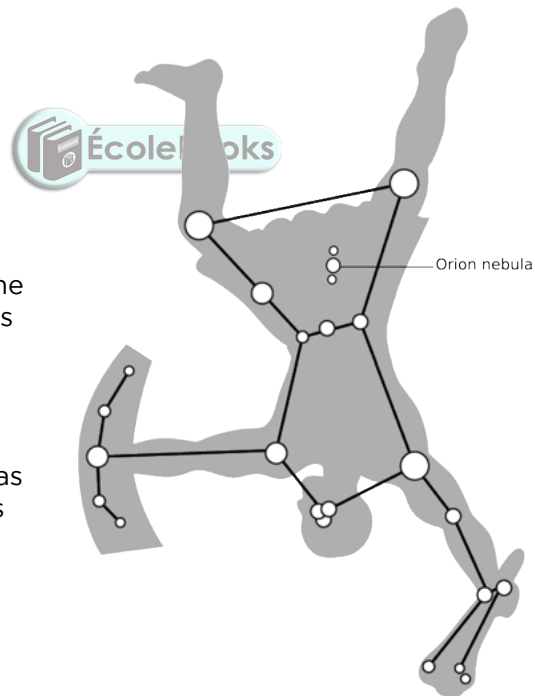

Over time the clouds contract, become denser and slowly heat up. The clouds also break up into smaller clumps. As the clumps get smaller they begin to flatten out into a disk shape. The centre of each clump will eventually contain a star and the outer disk of gas and dust may eventually form planets around the star.

This diagram shows how the stars make up the constellation of Orion, as seen in the southern hemisphere.

VISIT

Star birth (Orion Nebula).
bit.ly/1dkERqb

VISIT

Stellar evolution explained
(full documentary).
bit.ly/17Vfg2H

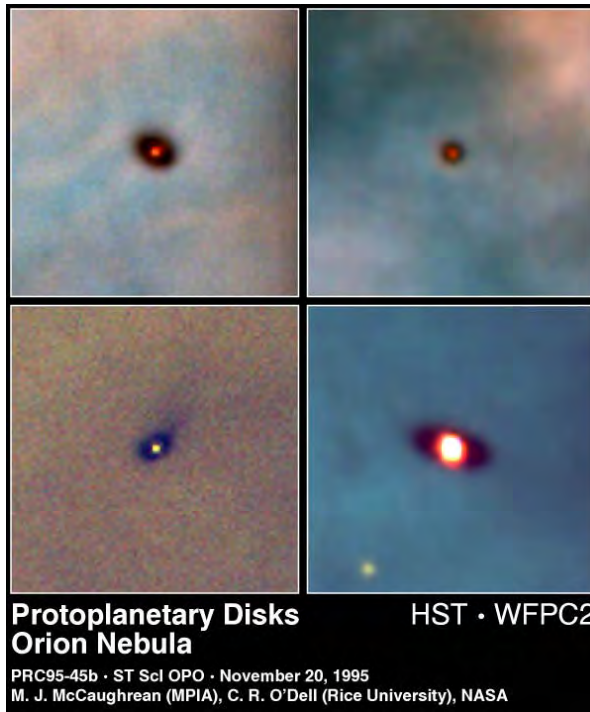

Hubble Space Telescope image of the Orion Nebula showing different protostars surrounded by a dark disk of gas and dust. These disks (called protoplanetary disks) may eventually form planets around the star.

As the contracting clump continues to heat up, a **protostar** is formed at the centre. A protostar is a dense ball of gas that is not yet hot enough at the centre to start nuclear reactions. This stage lasts for roughly 50 million years. As the collapse continues, the mass of the protostar increases, squeezing it further and increasing the temperature. If the protostar is massive enough for the temperature to reach 10 million degrees Celsius, then it becomes hot enough for nuclear reactions to start and the protostar will technically be referred to as a star.



TAKE NOTE

Do you remember that we learned about nuclear reactions last term in Energy and Change when looking at nuclear power plants?

Not as well known as its star formation cousin Orion, the Corona Australis region, with the Coronet cluster at its centre, is one of the nearest and most active star formation regions to us. This image shows the young stars at the centre, with gas and dust emissions.



The young star starts converting hydrogen to helium via **nuclear fusion** reactions. Nuclear reactions in stars produce vast amounts of energy in the form of heat and light, which is radiated into space. This energy production prevents the star from contracting further. As the star shines, the disk of dust and gas surrounding the star is slowly blown away by the star's **stellar wind** which leaves behind any planets if they have already formed.

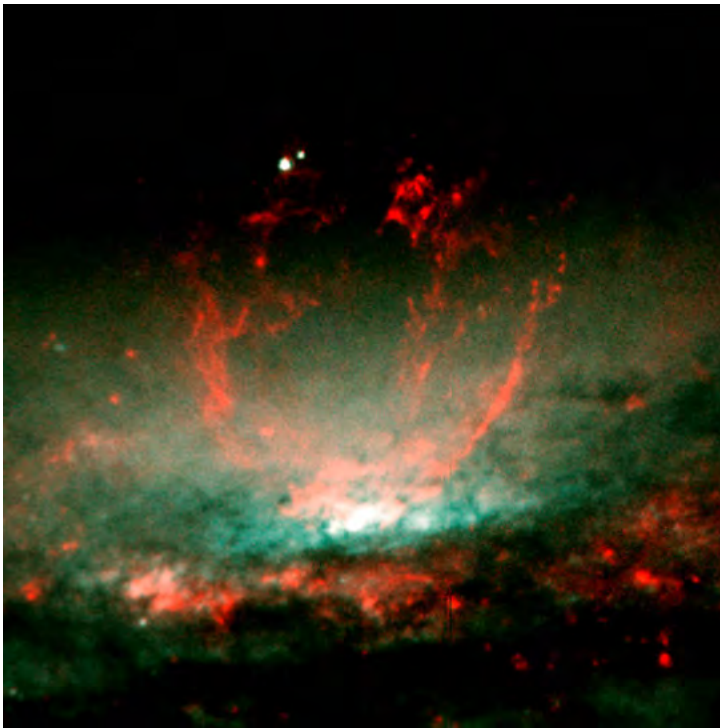

A large bubble of hot gas rising from glowing matter in a galaxy 50 million light years from Earth. Astronomers suspect the bubble is being blown by stellar winds, released during a burst of star formation.

VISIT

The end stages of star formation (birth).

bit.ly/18xqZDV

Star formation in the nearest galaxy outside the Milky Way, called the Large Magellanic Cloud (LMC), taken with the Hubble Space Telescope. This image shows glowing gas, dark dust clouds and young, hot stars.



TAKE NOTE

In the upper left of the image of Large Magellanic Cloud, you can see a collection of blue and white young stars. They are extremely hot and are some of the most massive stars known anywhere in the Universe.

TEACHER'S NOTE

The image shown here of the Large Magellanic Cloud, a satellite galaxy to the Milky Way, illustrates very clearly, an example of sequential star formation, where new star birth is triggered by the previous generation of massive stars. You can point some of these observations out to learners:

- Just below the cluster of hot stars in the top left, is an area of brightly emitting hydrogen gas, illuminated by the nearby hot stars.

- Further to the right are several smaller dark dust clouds with odd shapes. They can be seen silhouetted against the glowing gas. Several of these dark clouds have a bright rim as they are illuminated and being evaporated due to the action of radiation from neighboring hot stars.
- The region around the cluster of hot stars in the image is relatively clear of gas as the stellar winds and radiation from the stars have pushed the gas away.
- When this gas collides with and compresses surrounding dense clouds, the clouds can collapse under their own gravity and start to form new stars.
- The cluster of new stars in the upper left may have been formed this way, as it is located on the rim of the large central interstellar bubble of the complex. The stars in this cluster are now beginning to clear away the cloud from their birth, and are producing new opportunities for subsequent star birth.
- Learners may ask why some of these images have black boxes in the top, right corner, as though some of the image is missing. These strange, stair-shaped images come from the Hubble Telescope's Wide Field and Planetary Camera 2, or WFPC2. WFPC2 consists of four cameras, each of which takes a picture of a section of the target. It is like taking four pictures of a single scene, then putting them together to create the whole picture. But one of WFPC2's cameras, the top right, takes a magnified view of the section it is observing, to allow astronomers to study that section in finer detail. When the images are processed, that magnified section is shrunk down to the same size as the other sections, so that it fits into the image, resulting in the stair-shaped pattern. You can read more about it here: bit.ly/Hszbz3

5.2 Life of a star

VISIT

Stars: Life and death.
bit.ly/16GkRyE

This section covers the main stages of a star's life, from infancy to old age. Learners will also discover why stars do not all look the same and why they evolve at different rates and have different lifetimes: it is a consequence of having different masses. They will learn how important the mass of a star is in determining its evolution and observable characteristics.

A star is considered to be 'born' once nuclear fusion reactions begin at its centre. Initially hydrogen is converted to helium deep inside the star. A star that is converting hydrogen to helium is called a **main sequence star**. Stars spend most of their lives as main sequence stars, converting hydrogen to helium at their centres or cores. A star may remain as a main sequence star for millions or billions of years.

Main sequence stars are not all the same. They have different masses when they are born, depending on how much matter is available in the nebula from which they formed. These stars can range from about a tenth of the mass of the Sun up to 200 times as massive. Different mass stars have different observable properties.



Main sequence stars come in different sizes and colours. Their sizes range from around 0.1 to 200 times the size of the Sun. Their surface temperatures determine their colours and can range from under 3000°C (red) to over 30 000 °C (blue).

Main sequence stars also have different colours, depending on the temperatures of their surfaces. Look at the following picture and correctly label the temperatures of all the stars using the list of temperatures below. Which star represents our Sun?



Temperature list: 3000 °C, 4500 °C, 6000 °C, 10 000 °C, 40 000 °C

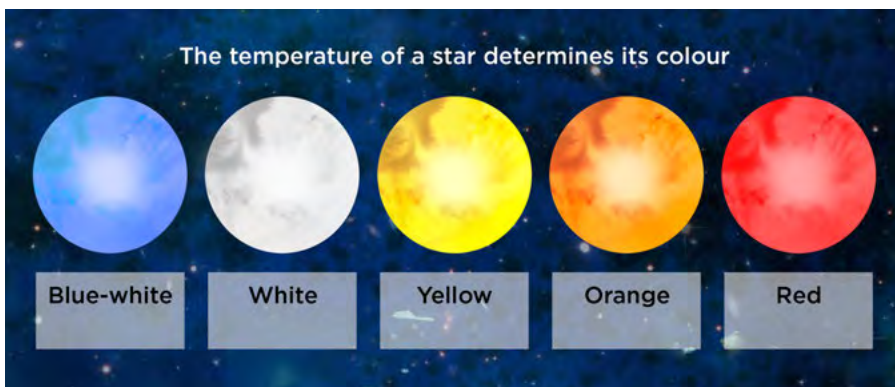

TEACHER'S NOTE

The following image shows the correct labels for the temperatures of different stars:

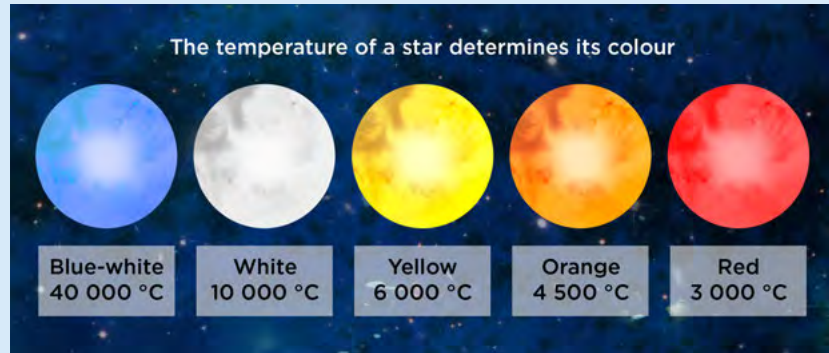

The yellow star represents our Sun.

VISIT

Curious about the Universe, but don't know where to start? Have a look at this step-by-step guide to becoming an awesome amateur astronomer.

bit.ly/1axh441

Why are hotter stars bluer in colour? Can you remember what you learnt about the spectrum of visible light in Grade 8? The colour blue corresponds to light at shorter wavelengths (higher frequencies) than the colour red. Shorter wavelengths (higher frequencies) correspond to higher energies and thus hotter temperatures. This is also seen in the flames of a fire or candle. If you look at the flames, the central regions are bluer (and hotter) than the outer regions, which are orange and yellow.

VISIT

The biggest stars in the Universe. bit.ly/1958N96



This artist's impression shows the relative sizes of young stars, from the smallest "red dwarfs", at about 0.1 solar masses, low mass "yellow dwarfs" such as the Sun, to massive "blue dwarf" stars weighing eight times more than the Sun, as well as the 300 solar mass star named R136a1.

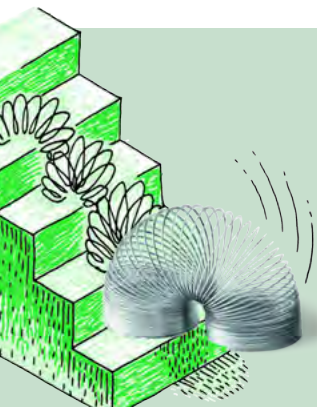

ACTIVITY: Observing Orion in the spring sky

Orion is an easily recognisable constellation visible in cities as well as in dark skies. In this activity learners will have to look at the night sky to spot the constellation and identify the stars Betelgeuse and Rigel and note their difference in colour. Orion is up in the east from around 00:30 at the beginning of October, however as the months progress it rises earlier. By the beginning of December Orion is visible from around 20:30 in the east. If observing the

constellation is unfeasible, you could ask learners to look at the image of the constellation in this chapter instead.

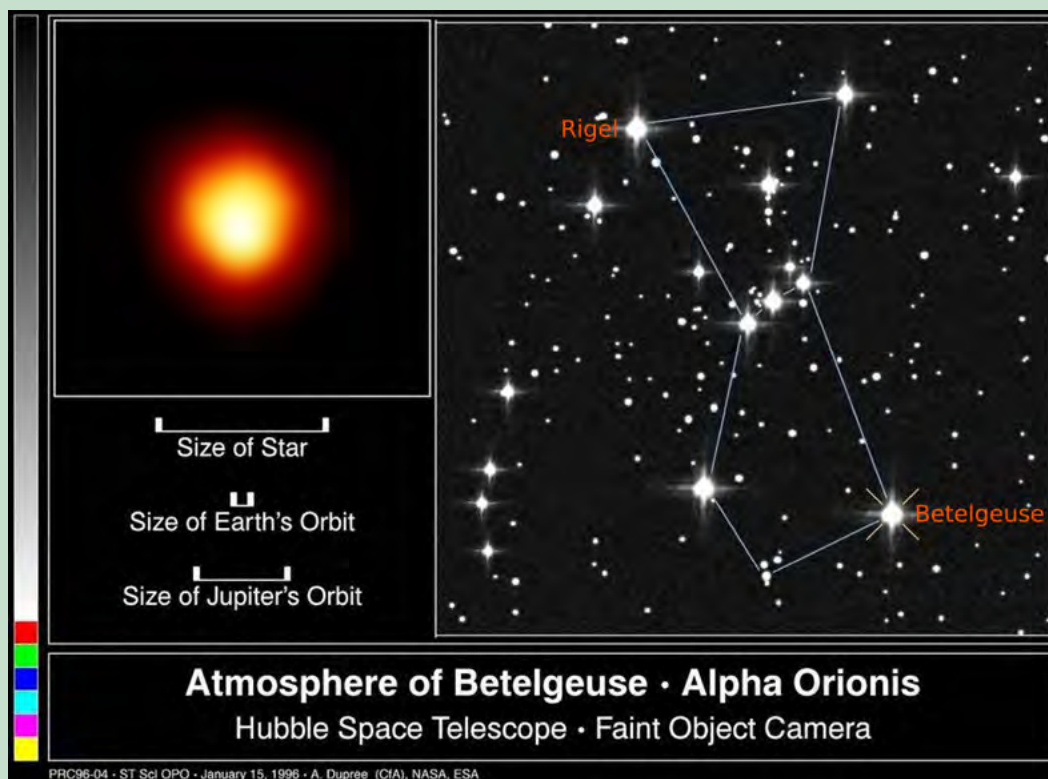

TAKE NOTE

At the beginning of October Orion is visible in the east from around 00:30 until morning. From the beginning of November Orion is visible in the east from around 22:30 and from the beginning of December it is visible in the east from around 20:30.

This is the first direct image of a star other than the Sun, made with NASA's Hubble Space Telescope. This is Betelgeuse, the star marking the shoulder of Orion, which we see in the bottom right of the constellation, when viewing Orion in the southern hemisphere.

MATERIALS:

- sky map

INSTRUCTIONS:

1. A clear sky is necessary for this task. Look outside at night towards the east and identify the constellation of Orion. A photograph of the constellation is included in this chapter for reference.
2. Identify the stars Betelgeuse and Rigel.

QUESTIONS:

1. What did you notice about the colour of the two stars Betelgeuse and Rigel?
Betelgeuse is red and Rigel is blue in colour.
2. Why do you think the stars look different? Hint: Look back at the colours of stars in the diagram before this activity to see what this tells us about their temperatures.
Rigel is much hotter than Betelgeuse, hence it is bluer.



VISIT

The colours of stars.
bit.ly/1dH5y1p

How long a main sequence star lives depends on how massive it is. More massive stars move onto the next stages of their lives more quickly than lower mass stars. In fact they are main sequence stars for a shorter time than lower mass stars.

A higher-mass star might have more material, but it also uses up the material more quickly due to its higher temperature. For example, the Sun will spend about 10 billion years as a main sequence star, but a star 10 times as massive will last for only 20 million years. A red dwarf, which is half the mass of the Sun, can last 80 to 100 billion years.

When the hydrogen in the centre of the star is depleted, the star's core shrinks and heats up. This causes the outer part of the star, the star's atmosphere, which is still mostly hydrogen, to start to expand. The star becomes larger and brighter and its surface temperature cools so it glows red. The star is now a **red giant star**. Betelgeuse, as you observed in the last activity, is a red giant star.



A colourful view of the globular star cluster NGC 6093 in the Milky Way, containing hundreds of thousands of ancient stars. Especially obvious are the bright red giants, which are stars similar to the Sun in mass that are nearing the ends of their lives.

Why does a red giant glow red?

TEACHER'S NOTE

It is red because it has cooled compared to when it was a main sequence star.

Why do you think red giants are called "giant" stars?

TEACHER'S NOTE

It is called a giant because the outer layers have expanded outwards and the star has got much larger than it was when it was a main sequence star.

Eventually the core of the star becomes hot enough for the next nuclear

reaction to start: atoms of helium collide and fuse into heavier elements such as carbon and oxygen. However, eventually the helium in the core will also be depleted. From this point onwards, the fate of the star is determined by its mass.

For medium-sized stars, such as the Sun, the temperature in their centres will never get high enough to fuse the newly-formed carbon and oxygen into heavier elements and so they do not evolve much further. Following the red giant phase, the star becomes unstable and will eventually die as you will discover in the next section.

VISIT

Scientists discover star devouring nearby planet.

bit.ly/1aDCvCz

TEACHER'S NOTE

The animation listed in the **Visit** box provides a very useful tool to give learners a sense of the scale of the Universe. If possible, you can project it up in your classroom and scale through it from a human all the way out until you get to some of the massive supergiants, and then beyond. You will also be able to see the scale of some of the objects mentioned in this chapter, such as the Crab Nebula, the Large Magellanic Cloud and Pillars of Creation.

VISIT

Scroll through this interactive animation to get a sense of the scale of some of the stars and other objects in our Universe.

bit.ly/1axmmwu

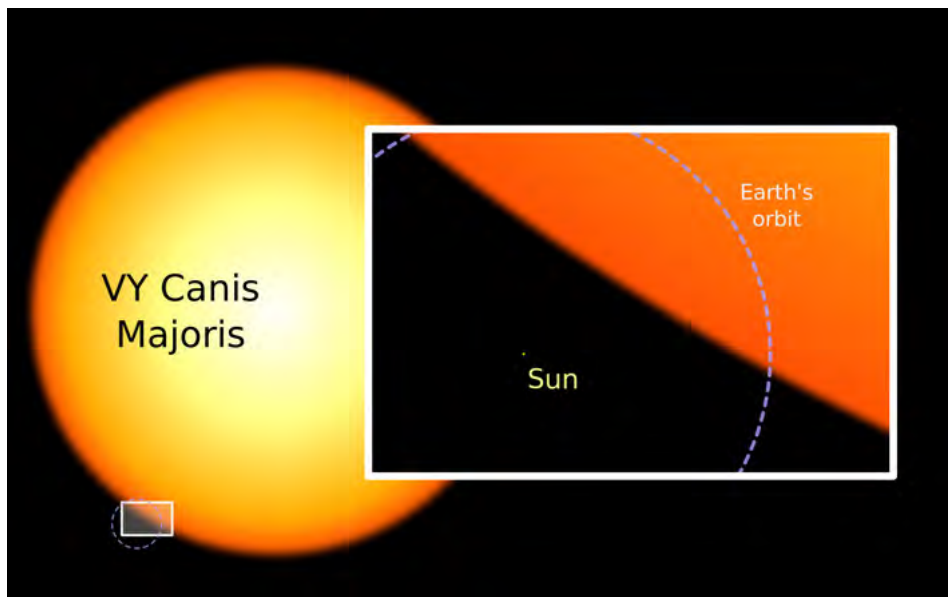

The relative sizes of the Earth, the present day Sun and a red supergiant star, Canis Majoris, in the constellation. The Sun will eventually evolve into a red giant star in about 4.5 billion years time.

5.3 Death of a star

TEACHER'S NOTE

In this section learners will discover how stars die. The focus is on the death of a low mass star like the Sun. However, for completeness, the way that high mass stars die is also briefly mentioned. There are two activities in this section related to the life of Sun-like stars. Both of these are intended to help learners remember and understand the sequence of phases that a star like the Sun undergoes during its life. There is a lot of unfamiliar terminology in stellar

VISIT

Read interesting articles on the latest developments in astronomical research on **Space Scoop**, an astronomy news service.
bit.ly/IdkMBbU

evolution and it can be confusing for learners. Hopefully by doing activities rather than simply reading about the different stages in a Sun-like star's evolution, learners will find the subject easier to understand.

As a star enters the final stages of its life, after it has become a red giant, the star becomes unstable and expands and contracts over and over. This causes the star's outer layers to become detached from the central part of the star and they gently puff off into space. When the last of the gas in the star's outer layers is blown away, it forms an expanding shell around the core of the star called a **planetary nebula**. Planetary nebulae glow beautifully as they absorb the energy emitted from the hot central star. They can be found in many different shapes, as shown in the following images.

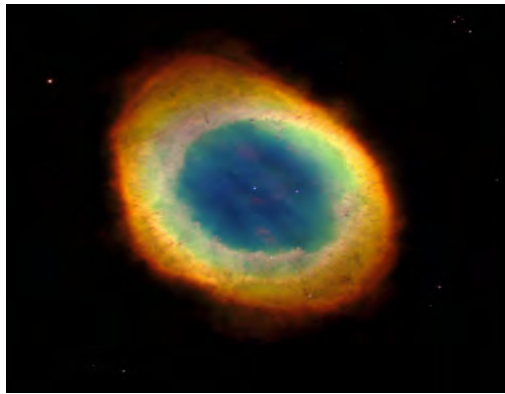

The beautiful Ring Nebula. The gas is lit up by the light from the central star which is the faint white dot in the centre of the nebula.



The Boomerang Nebula is a young planetary nebula and the coldest object found in the Universe so far.



Kohoutek 4-55 Nebula contains the outer layers of a red giant star that were expelled into interstellar space when the star was in the late stages of its life.



The Butterfly Nebula. The dying central star itself cannot be seen, because it is hidden within a doughnut-shaped ring of dust.

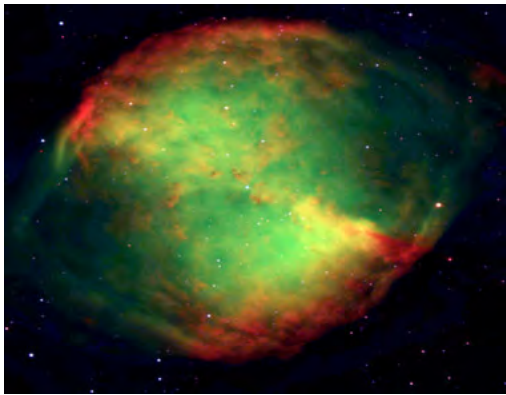

The Dumbbell Nebula.



The Helix Nebula.

VISIT

Earth consumed by red giant star in 5 billions years time.

bit.ly/1iqMpYO

VISIT

A tour of a planetary nebula.

bit.ly/HsBYrR

Some time after puffing off its outer layers, the central star will run out of fuel. When this happens the central star begins to die. Gravity causes the star to collapse inwards and the star becomes incredibly dense and compact, about the size of the Earth. The star has then become a **white dwarf** star.



An ultraviolet image of the Helix Nebula. As the star in the centre approaches the end of its life and runs out of fuel, it shrinks into a much smaller, hotter and denser white dwarf star.



White dwarfs have this name because of their small size and because they are so hot that they shine with a white hot light. The central parts of stars are much hotter than their surfaces, and a white dwarf is made from the remaining central parts of a star which explains why they are so hot.

The following image shows the relative size of Sirius B, a nearby white dwarf star, compared to some of the planets in our solar system. Stars and stellar remains can be smaller than planets.

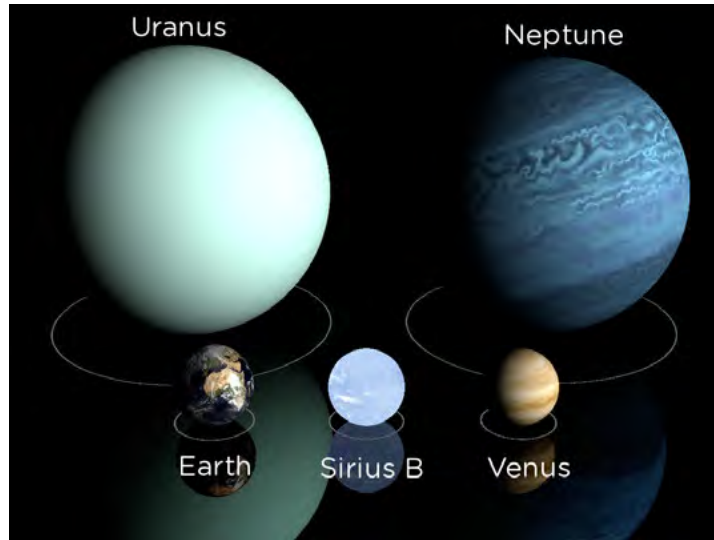

White dwarfs no longer produce energy via nuclear reactions and so as they radiate their energy into space in the form of light and heat. They slowly cool down over time. Eventually, once all of their energy is gone, they no longer emit any light. The star is now a dead **black dwarf** star and will remain like this forever.



ACTIVITY: Life cycle of a Sun-like star

TEACHER'S NOTE

This activity can be performed in pairs or small groups. This activity demonstrates the life of a Sun-like star using a yellow balloon to represent the Sun. Learners must follow the instructions to demonstrate each of the phases that a star like the Sun goes through during its life. This activity is best completed in pairs where one member "gives the orders" and the other member completes the activity. If you have time you can repeat the activity, swapping the pairs around.

MATERIALS:

- yellow round balloon - one per pair or group
- black marker
- red marker
- scissors
- 2 cm small white styrofoam ball - one per pair

INSTRUCTIONS:

1. In this activity you will work in pairs. One of you will instruct your partner using the instructions below. Your partner will follow your instructions.

Decide which of you will be the instructor and which of you will be the experimenter.

2. Experimenter: Insert the white styrofoam ball into the deflated balloon.
3. Instructor: Read out the step-by-step instructions from the table below (listed in order). First state the time from the star's birth which is given in the left hand column, then tell your partner what to do with the balloon.
4. Experimenter: Follow the instructions from your partner very carefully. You will be demonstrating how a Sun-like star evolves over time.

Step Number	Instructions
1) Star is born	Blow up the balloon to about 6 cm in diameter
2) 5 million years	Wait
3) 10 million years	Wait
4) 500 million years	Wait - planets are being formed around the star.
5) 1 billion years	Blow the balloon up a little bit
6) 9 billion years	Blow up the balloon some more and colour it red - it is now a red giant star
7) 10 billion years	Blow the balloon up a little bit. The outer layers are now being blown off. To simulate this, slowly allow the balloon to deflate. Cut the balloon into pieces and scatter them around the white ball. The star has now become a white dwarf (the ball) surrounded by a planetary nebula (the pieces of balloon).
8) 50 billion years	Move the planetary nebula farther away from the white dwarf.
9) 500 billion years	Remove the planetary nebula and colour the ball black - the star is now a black dwarf.

TAKE NOTE

The plural of nebula is nebulae. Planetary nebulae have nothing to do with planets but were named like this in the 1700s because they resembled planets when observed with the telescopes of the time.



The different stages of evolution of a star like the Sun are summarised in the diagram below and compared to the lifecycle of a person.

VISIT
How the Sun will die.
bit.ly/16iwJ7U

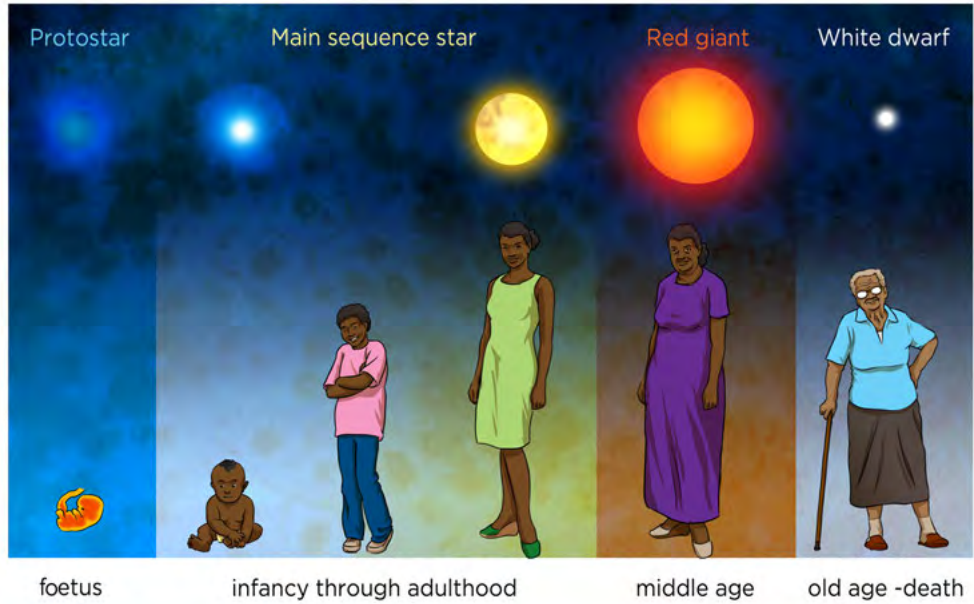

Let's take a closer look at the life of our star, the Sun.



ACTIVITY: The life cycle of the Sun

INSTRUCTIONS:

1. The diagram below shows the life of our Sun. The Sun is a common type of star of average size and mass.
2. Complete the sentences by filling in the gaps which summarize the evolution of our Sun over time.

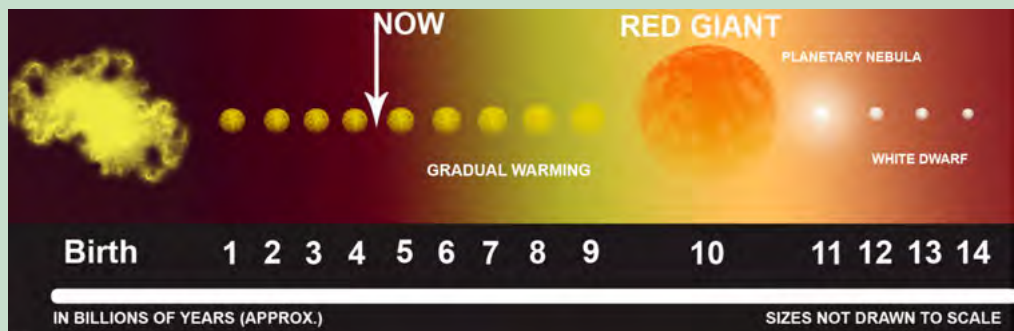

QUESTIONS:

1. The Sun is currently about halfway through its lifetime as a _____ star. In about 4.5 billion years time the Sun will swell up to form a _____ star engulfing the Earth as it does so.

The Sun is currently about halfway through its lifetime as a main sequence star. In about 4.5 billion years time the Sun will swell up to form a red giant star engulfing the Earth as it does so.

2. After the Sun has become a red giant, it will eventually become unstable and puff off its outer layers forming a beautiful _____. The central core of the Sun will be left exposed in the centre of the planetary nebula.

After the Sun has become a red giant, it will eventually become unstable and puff off its outer layers forming a beautiful planetary nebula. The central core of the Sun will be left exposed in the centre of the planetary nebula.

3. Once the fuel runs out in the core of the Sun, nuclear reactions will _____. The Sun will then have become a hot _____ star, left behind at the centre of the planetary nebula.

Once the fuel runs out in the core of the Sun, nuclear reactions will stop. The Sun will then have become a hot white dwarf star, left behind at the centre of the planetary nebula.

4. As there are no ongoing nuclear reactions, as the white dwarf shines it slowly cools and will eventually form a _____ dwarf.

As there are no ongoing nuclear reactions, as the white dwarf shines it slowly cools and will eventually form a black dwarf.

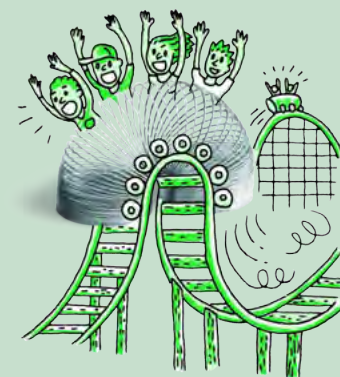

ACTIVITY: Flow diagram poster showing the life of a Sun-like star

TEACHER'S NOTE

In this activity learners will make a poster showing the different stages of stellar evolution experienced by a Sun-like star. The idea is to create a flow diagram showing which stage leads on to the next. Learners can use photographs or pictures printed from the internet or they may draw their own pictures depending on time and resources available. An example is presented below for guidance.

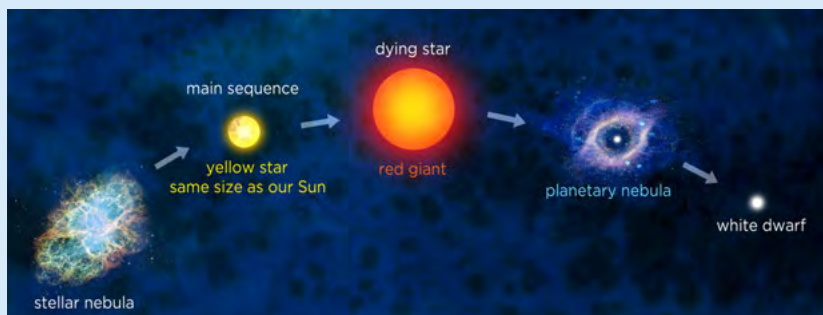

MATERIALS:

- paper or card for the poster
- pencils, crayons or paint for drawing
- printouts of photographs or pictures of the various stages in the Sun's life

TEACHER'S NOTE

If learners have access to the internet, they can print out images of the various stages. otherwise they can use the reference diagrams in the workbook to draw pictures.

INSTRUCTIONS:

1. Draw a flow diagram showing the key stages in a Sun-like star's life. Include the birth, life, aging and death of the star. If you have access to printouts of photos or drawings of the key stages you could paste them onto the poster instead of drawing the key stages.
2. Label each stage and indicate clearly with arrows the direction of flow in the evolutionary stages.
3. *Advanced:* Write down approximately how long each stage lasts. You can use the timeline of the Sun's evolution in this chapter to help you.

TAKE NOTE

Here we are not talking about **bigger** stars, but rather stars that are more **massive**. It is not the size that counts, but the mass of the star.

QUESTIONS:

1. Where are stars born?
In vast cold clouds of gas and dust called nebulae.
2. Why is a red giant so named?
It is called a red giant because it is red in colour and much larger than a main sequence star.
3. What kind of stellar remnant is left behind once a star like the Sun dies?
A white dwarf star.
4. What is a planetary nebula?
A glowing nebula formed by an expanding shell of gas around an aging star.
5. How big is a white dwarf?
About the size of the Earth.

TEACHER'S NOTE

The following content on supernovae is not in CAPS, but has been included here as the stellar evolution discussed previously explains small and medium-sized stars. Giant stars have a different end, as discussed here.

So far we have looked at stars that are about the same mass as our Sun. But, what about stars that are more massive? How do they die?

Stars more than eight times the mass of the Sun end their lives spectacularly. When the hydrogen at their cores becomes depleted, they swell into red supergiants which are even larger than red giants.

TEACHER'S NOTE

The temperature in the cores of these supergiants gets high enough for them to fuse elements heavier than hydrogen and helium.

A red supergiant can fuse successively heavier and heavier elements for a few million years until its core is filled with iron. At this point, nuclear reactions stop and the star collapses rapidly under its own gravity. The collapsing outer layers of the star hit the small central core with such a force that they rebound and send a ripple outwards through the star blowing the outer layers of the star into space in a huge explosion called a **supernova**.



The Crab Nebula. This giant glowing cloud of gas is the remains of the outer layers of a star that exploded in a supernova explosion. In the centre is a rapidly spinning neutron star.

oks

VISIT

The Crab Nebula.
bit.ly/1hpnyXD

For a week or so, a supernova can outshine all of the other stars in its galaxy. However, they quickly fade over time. The central star left behind is either made of neutrons and it is called a **neutron star**, or if the initial star was really massive, a **black hole** forms. The leftover neutron star or black hole is surrounded by an expanding cloud of very hot gas.

TEACHER'S NOTE

A black hole is a region of space where gravity is so strong that even light cannot escape. The gravity is so strong because matter has been squeezed into a tiny space. This can happen when a star dies. As light cannot escape you cannot actually see a black hole. Black holes can be detected by their gravitational effects on nearby visible objects, or in the case of a black hole that is actively absorbing material from its surroundings, the material may emit light before it is sucked into the black hole. As well as stellar mass black holes, there are much more massive black holes in the centres of galaxies, called supermassive black holes.

VISIT

The largest black holes in the Universe bit.ly/Hq36sl and what's inside black holes bit.ly/1aDGtet

In February 1987, astronomers observed a supernova explosion, called Supernova 1987A. It is one of the brightest stellar explosions observed since the

invention of the telescope 400 years ago. The supernova belongs to the Large Magellanic Cloud, a nearby galaxy about 168 000 light-years away. Even though the stellar explosion took place around 166 000 BC, its light arrived here less than 25 years ago.

An image of the supernova called Supernova 1987A. The outer layers of the star have formed beautiful rings expanding into space.

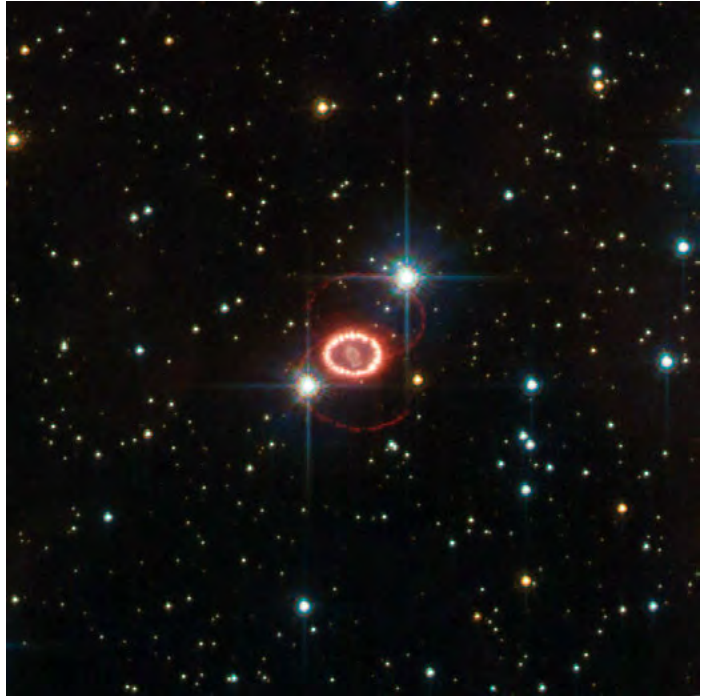

Supernovae have also been observed previously with the naked eye before the invention of the telescope. On 9 October 1604, sky watchers, including astronomer Johannes Kepler, spotted a "new star" in the sky. Now, we have images of the remnants of the supernova and know that it is not a new star, but rather the death of a massive star.

VISIT

How many people are in space right now? Find out here. bit.ly/1g8OX0v

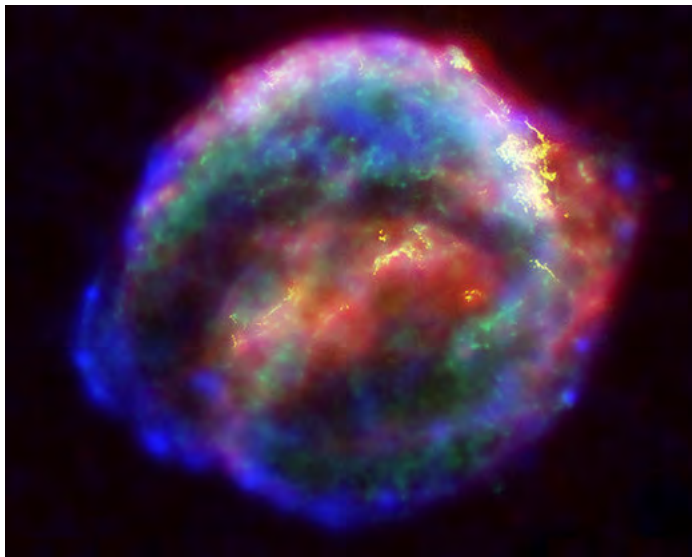

The remnants of Kepler's supernova. The explosion was observed in 1604.

SUMMARY:

Key Concepts

- Stars are born in giant, cold clouds of gas and dust called nebulae.
- A star is born once it becomes hot enough for fusion reactions to take place at its core.
- Stars spend most of their lives as main sequence stars fusing hydrogen to helium in their centres.
- The Sun is halfway through its life as a main sequence star and will swell up to form a red giant star in around 4.5 billion years.
- Stars similar to the Sun end their lives as planetary nebulae and leave behind a small hot white dwarf star at the centre of the planetary nebula.

Concept Map

The concept map on the life cycle of stars has been started, but you need to finish it by summarising the concepts for each stage, namely birth, life and death of a star.

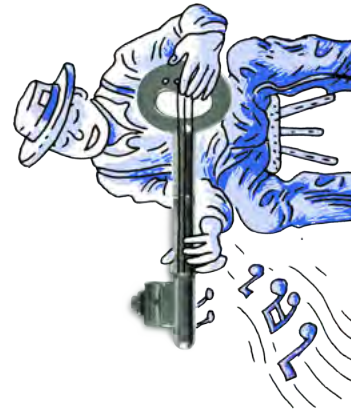

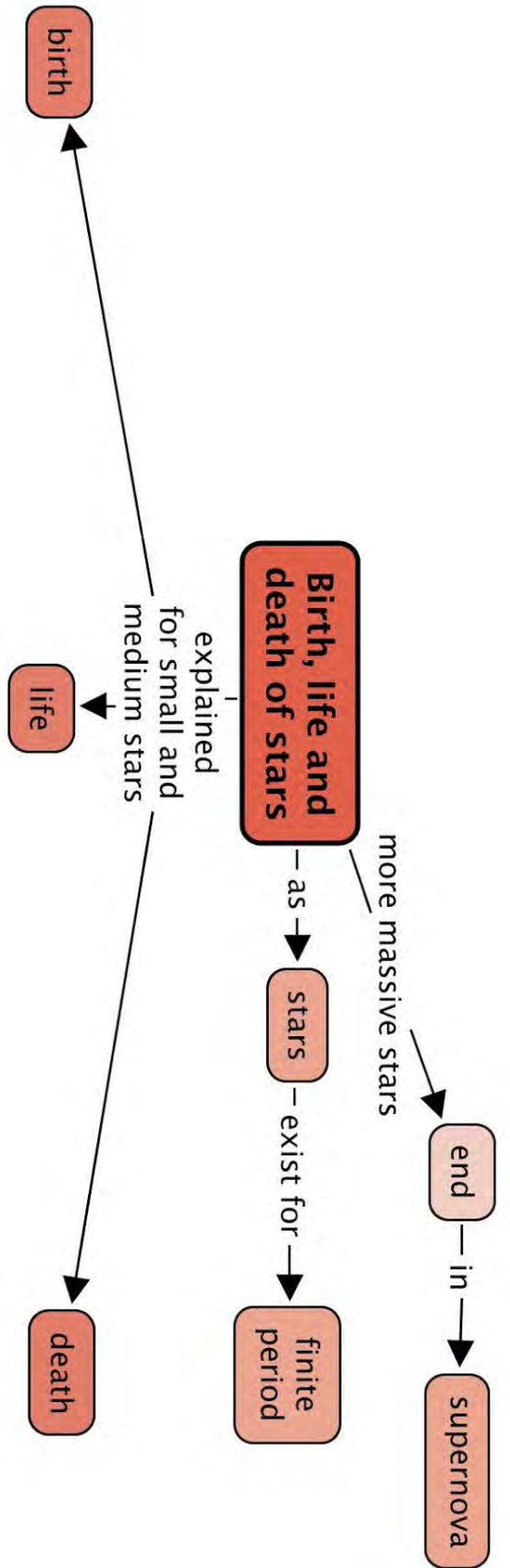

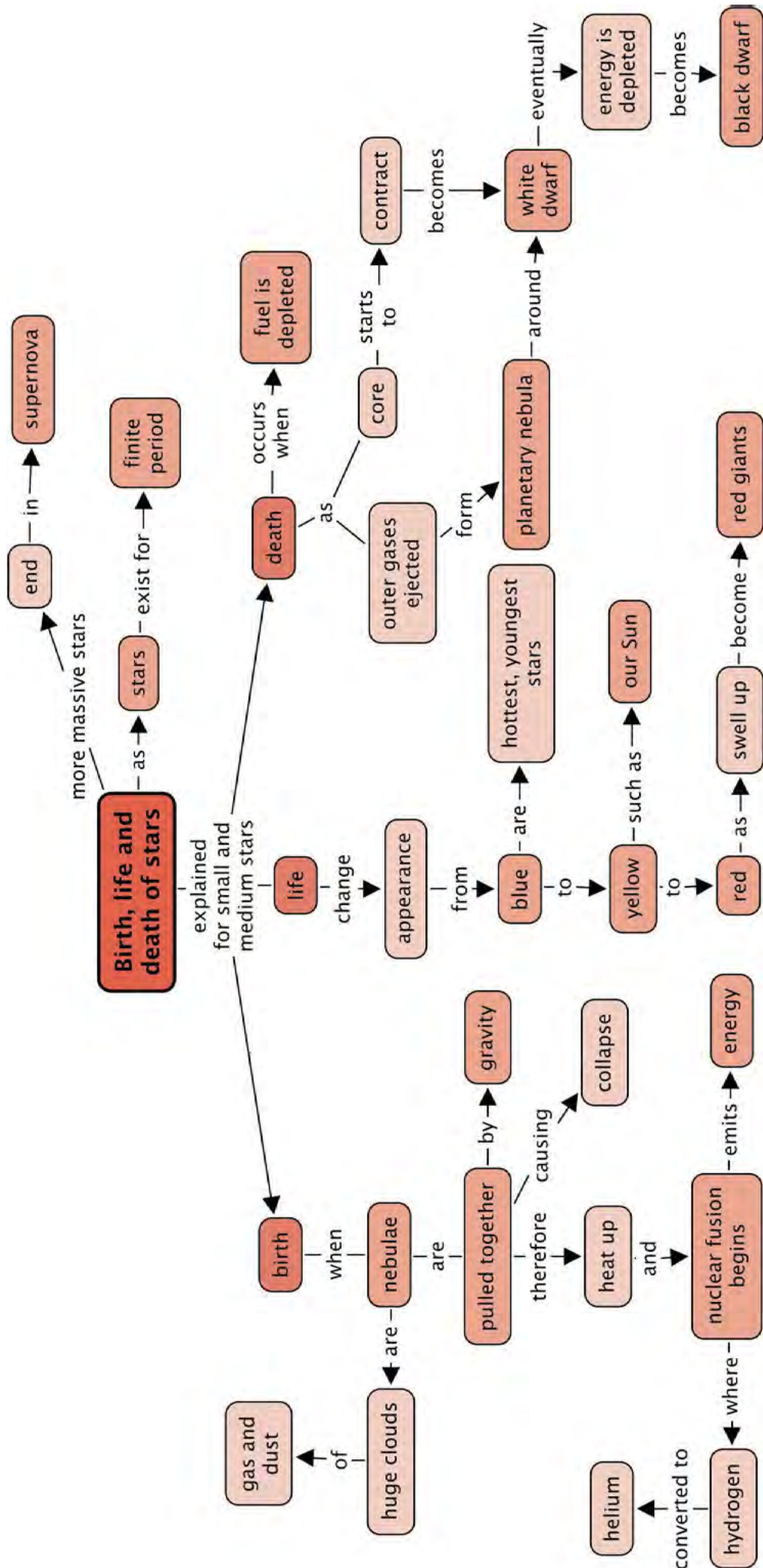

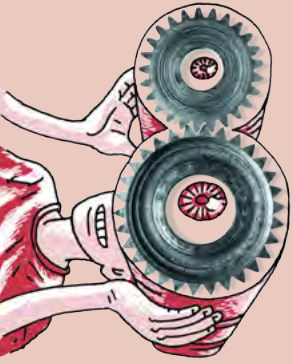

REVISION:

1. What is the name of the giant clouds where stars are formed? [1 mark]
Nebulae (singular nebula).
2. In the human life cycle, a foetus is the unborn baby in a mother's womb. What is the equivalent stage in a star's life called? [1 mark]
It is called a protostar.
3. Under what conditions do astronomers technically say a star has been born? [1 mark]
If there is enough gas and dust for the temperature to become hot enough for nuclear reactions to start, the protostar will then technically be called a star.
4. Which star colour is hotter, white or yellow? [1 mark]
A white star is hotter than a yellow star.
5. What nuclear reaction does a main sequence star undergo? [2 marks]
A main sequence star burns hydrogen to helium at its core. This is called nuclear fusion.
6. Once the Sun has exhausted its hydrogen fuel supply, it will swell up to form what type of star? [1 mark]
A red giant.
7. Low mass stars like the Sun eject their outer layers. What is the name of the object they form when they do this? [1 mark]
Low mass stars eject their outer layers forming a planetary nebula.
8. What kind of star is left behind after a planetary nebula? [1 mark]
A white dwarf.
9. What is the difference between a stellar nebula and a planetary nebula? [2 marks]
A stellar nebula is where stars are born, whereas a planetary nebula is what a star forms at the end of its life.
10. Study the following diagram showing a star's evolution.

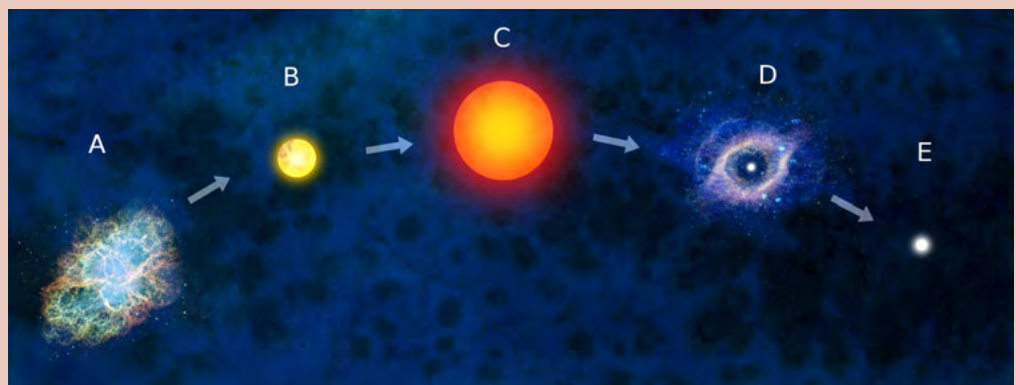

- a) Provide labels for the different stages. [5 marks]
- b) What changes occur from stage B to form C? [2 marks]
- c) Some time after puffing off its outer layers at stage D, the fuel of the central star will have become depleted. What causes the star to collapse inwards to become E? [1 mark]
- d) What eventually happens to the star after stage E? [1 mark]

Label	Stage
A	<i>Stellar nebula</i>
B	<i>Main sequence star/Yellow star</i>
C	<i>Red giant</i>
D	<i>Planetary nebula</i>
E	<i>White dwarf</i>

a)

b) *When the hydrogen in the centre of the star is depleted, the star's core shrinks and heats up. The outer part of the star, which is still mostly hydrogen, starts to expand. The star becomes larger, brighter and its surface temperature cools so it glows red. The star is now a red giant star.*

c) *Gravity causes the star to collapse inwards and form a very dense star.*

d) *The energy of the white dwarf will have become depleted and it stops emitting light and becomes a black dwarf star forever more.*

11. Massive stars die in powerful explosions. What are these explosions called?

[1 mark]

Supernovae explosions (singular supernova).

Total [21 marks]



GLOSSARY

altitude:	height above sea level
atmosphere:	the layer of gases surrounding the Earth and held in place by gravity
aurora:	a natural phenomenon whereby charged particles from the Sun interact with atmospheric particles; this is observed as bright, coloured "lights" in the sky, mostly in polar regions
bellows:	a device that produces a stream of air when it is squeezed
biosphere:	the part of the Earth and its atmosphere in which living organisms exist or that is capable of supporting life
black dwarf:	a white dwarf that has sufficiently cooled and used up all of its energy so that it no longer emits any heat or light; the star is now dead and will remain like this
blast furnace:	used in the extraction of iron from iron-ore, a high temperature oven in the form of a tower into which compressed air can be introduced from below
bloomery:	a type of oven used for purifying iron from iron ore
brittle:	material that is hard, but can break or shatter easily
carbon dioxide:	a gas with the chemical formula CO ₂
cementation:	the process of solidifying sediments by chemical compounds acting as glue
CFCs:	chlorofluorocarbons, are molecules which release chlorine atoms due to solar radiation in the stratosphere
climate change:	a significant and lasting change in weather patterns; if there is a change in the world's weather patterns, it is global climate change
compaction:	an increase in the density of something
composition:	what makes up a substance or a mixture
constellation:	a group of stars in a recognisable pattern
continental crust:	the thick part of the Earth's crust that forms the continents
cooling:	lowering the temperature
core:	innermost layer of the Earth
crust:	the thin, solid, outermost layer of the Earth
cycle:	a continuous process where the last step feeds into the first again
density separation:	a separation method where the differing densities of particles are used to separate them out
deposition:	the process where sediments, rocks and sand are deposited (laid down) by wind or water
electromagnets:	a soft metal core made into a temporary magnet by passing current through a coil surrounding it

erosion:	the breakdown and movement of the Earth's surface by natural agents like wind and water
evolution:	(of stars) the changes a star undergoes as it is born, lives and dies
excavation:	the process of removing rock containing ore from the surrounding rock
exosphere:	considered part of outer space; the uppermost layer directly above the thermosphere, where the gases thin out and the atmosphere merges with space
exploration:	the process of finding out where profitable mineral deposits are located
extrusive rock:	igneous rock which forms when magma flows out onto the surface of the Earth as lava
flotation:	a separation method by which hydrophobic particles are separated from hydrophilic particles by blowing air through the mixture
geochemical methods:	exploration methods using knowledge of geology and the chemistry of minerals
geophysical methods:	exploration methods using knowledge of geology and the physical properties of minerals
geosphere:	the core, mantle and crust of the Earth
global warming:	a gradual increase in the temperature of the Earth's atmosphere
greenhouse effect:	the trapping of the Sun's energy in the lower part of the atmosphere due to the presence of greenhouse gases
greenhouse gases:	gases like water vapour, carbon dioxide and methane, which let through sunlight but reflect ultraviolet radiation
hydrosphere:	all the water, in all its forms, found on Earth
igneous rock:	a rock type formed by magma or lava
International Space Station:	a multinational space station, used for research purposes, which orbits the Earth at 370 km above the surface
intrusive rock:	igneous rock which forms from magma deep below the surface of the Earth
ionosphere:	the region mainly in the thermosphere where high energy light (UV light) can cause atoms, molecules or substances to form an ion or ions, typically by removing one or more electrons
lithosphere:	the outer part of the Earth consisting of the crust and the upper part of the mantle; it includes all rock, soil and minerals found on Earth
magnetic separation:	a separation method based on the magnetic properties of the mixture
main sequence star:	a star that has hydrogen undergoing nuclear fusion reactions into helium in its core
mantle:	the middle layer of the Earth
melting:	the change from a solid to a liquid as a result of heating

mesosphere:	the layer of the Earth's atmosphere above the stratosphere, extending to about 80 km above the surface of the Earth
metamorphic rock:	a rock type formed through the transformation, or metamorphosis, of other rock types
meteor:	a small body of mass entering the Earth's atmosphere from space which emits light as a result of friction and heat, and appears as a streak of light
meteorite:	a meteor which has collided with the Earth
methane:	a gas with the chemical formula CH ₄
mineral:	natural compounds formed through geological processes; the term "mineral" includes both a material's chemical composition and its structure
nebula:	a vast cloud of gas and dust in space
neutron star:	an extremely dense star made of neutrons about the size of a small town in diameter
northern lights:	the aurora in the northern hemisphere; also called aurora borealis
nuclear fusion:	process in which two light nuclei of atoms combine to produce a heavier single nucleus, with a total mass slightly less than that of the total initial material, the difference in mass is radiated as energy
oceanic crust:	the thinner part of the Earth's crust that underlies the oceans
ore:	a naturally occurring solid material from which a metal or valuable mineral can be extracted
overburden:	the layer of rock or sand overlying a mineral deposit
ozone:	a gas molecule found in the stratosphere consisting of 3 oxygen atoms (O ₃)
panning:	a separation method based on the density gradient of the mixture
PGM:	platinum group metals, which includes ruthenium, rhodium, palladium, osmium, iridium and platinum, and are elements on the Periodic Table
planetary nebula:	a cloud of gas (the remains of the original star's atmosphere) surrounding an old star; these have a confusing name because they actually have nothing to do with planets at all
protostar:	a contracting mass of gas that will become a star once it is hot enough for nuclear fusion to start
radiation:	the transfer of energy from a source that does not require physical contact or movement of particles
red giant star:	an old, bright, very big, cool star; main sequence stars evolve to become red giant stars once the hydrogen in their cores has been depleted
rehabilitation:	an area is restored to certain specifications, for example an area that has been mined is rehabilitated by planting trees or grass

remote sensing:	gathering information from a distance, without making physical contact
sediment:	particles, for example those that arise from erosion and weathering, settle in layers
sedimentary rock:	a rock type formed from solidifying sediment
sedimentation:	the deposition and solidification of sediment
size separation:	a separation method based on the size of the particles
slag:	the waste product extracted from a blast furnace after extracting iron from iron-ore
slurry:	a watery mixture of solids and liquids
solidify:	becoming a solid
southern lights:	the aurora in the southern hemisphere; also called aurora australis
stellar wind:	a flow of neutral or charged gas ejected from a star (the solar wind refers specifically to the stellar wind of our Sun)
stellar:	of stars, such as a stellar nebula
stratosphere:	the layer of the Earth's atmosphere above the troposphere, extending to about 50 km above the surface of the Earth
supernova:	an explosion in a high mass star where the outer layers of the star are flung off into space
temperature gradient:	how much the temperature changes as height above sea level (altitude) increases
thermosphere:	the layer of the Earth's atmosphere above the mesosphere, extending from about 480 to 600 km above the surface of the Earth
topsoil:	the upper surface of the Earth consisting of a layer of vegetation and soil
troposphere:	the lowest layer of the Earth's atmosphere, extending from sea level to about 9-17 km
water vapour:	a gas with the chemical formula H ₂ O; water in its gaseous form
weathering:	the wearing away of rocks as a result of exposure to wind, water and ice
white dwarf:	a small hot, very dense star that is the size of a planet

A Assessment rubrics

The assessment guidelines for Gr 7-9 Natural Sciences are outlined in CAPS on page 85. Provided here are various rubrics as a guideline for assessment for the different tasks which you would like to assess, either **informally** (to assess learners' progress) or **formally** (to record marks to contribute to the final year mark). These rubrics can be photocopied and used for each learner.

The various rubrics provided are:

- **Assessment Rubric 1: Practical activity**
 - To be used for any practical task where learners are required to follow instructions to complete the task.
- **Assessment Rubric 2: Investigation**
 - To be used for an investigation, especially where learners have to write their own experimental report or design the investigation themselves.
- **Assessment Rubric 3: Graph**
 - To be used for any graph or translation task you would like to assess, either on its own or within another activity.
- **Assessment Rubric 4: Table**
 - To be used when learners have to draw their own table and you would like to assess it.
- **Assessment Rubric 5: Scientific drawing**
 - To be used when learners have to do a drawing, particularly in Life and Living.
- **Assessment Rubric 6: Research assignment or project**
 - To be used when learners have to do a research assignment or project, either outside of class or in class time, and either individually or in groups.
- **Assessment Rubric 7: Model**
 - To be used when learners have to design and build their own scientific models.
- **Assessment Rubric 8: Poster**
 - To be used when learners have to make a poster, either individually or in a group.
- **Assessment Rubric 9: Oral presentation**
 - To be used when learners have to give an oral presentation to the class on a selected topic.
- **Assessment Rubric 10: Group work**
 - To be used to assess any work where learners are required to complete the task as a group. This rubric is designed to assess the group as a whole.

A.1 Assessment Rubric 1: Practical activity

Name:

Date:

Task:

Assessment criteria	0	1	2	Comments
Following instructions	Unable to follow instructions	Instructions followed with guidance	Able to work independently	
Observing safety precautions	Unable to observe safety precautions	Sometimes does not follow safety precautions	Able to follow safety precautions completely	
Ability to work tidily	Cannot work tidily	Can work tidily		
Cleans up afterwards	Does so once reminded	Does so without reminding		
Organisation	Disorganised	Fairly organised	Organised and efficient	
Use of apparatus, equipment and materials	Always used incorrectly and materials wasted	Sometimes used correctly and aware of material usage	Apparatus and materials used correctly and efficiently	
Results or final product	No result or final product	Partially correct results or product	Results or product correct	
Answers to questions based on activity	No answers provided or most are incorrect	Can answer questions and at least 60% are correct	Can answer application and questions correctly	
			Total	/15

A.2 Assessment Rubric 2: Investigation

Name:

Date:

Task:

Assessment criteria	0	1	2	3	Comments
Aim	Not stated or incorrect	Not clearly stated	Clearly stated		
Hypothesis or prediction	Not able to hypothesise	Able to hypothesise, but not clearly	Clearly hypothesises		
Materials and apparatus	Not listed or incorrect	Partially correct	Correct		
Method	None	Confused, not in order or incorrect	Partially correct	Clearly and correctly stated	
Results and observations (recorded either as a graph, table or observations)	No results recorded or incorrectly recorded	Partially correctly recorded	accurately recorded but not in the most appropriate or specified way	Correctly and accurately recorded in the most appropriate or specified way	
Analysis or discussion	No understanding of the investigation	Some understanding of the investigation	Understands the investigation	Insightful understanding of the investigation	
Evaluation	No attempt	Partially correct	Correct, but superficial	Critical evaluation with suggestions	
Neatness of report	Untidy	Tidy			
Logical presentation of report	Not logical	Some of report is logically presented	Report is logically presented		
				Total	/25

A.3 Assessment Rubric 3: Graph

Name:

Date:

Task:

Assessment criteria	0	1	2	Comments
Correct type of graph	Not correct	Correct		
Appropriate heading, describing both variables	Not present	Present, but incomplete	Complete	
Independent variable on x-axis	Not present or incorrect	Present		
Dependent variable on y-axis	Not present or incorrect	Present		
Appropriate scale on x-axis	Incorrect	Correct		
Appropriate scale on y-axis	Incorrect	Correct		
Appropriate heading for x-axis	Not present or incorrect	Correct		
Appropriate heading for y-axis	Not present or incorrect	Correct		
Units for independent variable on x-axis	Not present or incorrect	Correct		
Units for dependent variable on y-axis	Not present or incorrect	Correct		
Plotting points	All incorrect	Mostly or partially correct	All correct	
Neatness	Untidy	Tidy		
Graph size	Too small	Large		
			Total	/15

A.4 Assessment Rubric 4: Table

Name:

Date:

Task:

Assessment criteria	0	1	2	Comments
Appropriate heading, describing both variables	Not present	Present, but incomplete	Complete	
Appropriate column headings	Not present or incorrect	Mostly correct	Correct and descriptive	
Appropriate row headings	Not present or incorrect	At least half correct	All correct	
Units in headings and not in body of table	None present	Present but in the body	Present and in the headings	
Layout of table	No horizontal or vertical lines	Some lines drawn	All vertical and horizontal lines drawn	
Data entered in table	Not correct	Partially correct	All correct	
			Total	/12



A.5 Assessment Rubric 5: Scientific drawing

Name:

Date:

Task:

Assessment criteria	0	1	2	Comments
Appropriate, descriptive heading	Not present	Present, but incomplete	Complete	
Appropriate size of drawing (sufficiently large on page)	Incorrect (too small)	Correct		
Accuracy of drawing (correct shape and proportion of parts)	Incorrect	Somewhat correct	Correct	
Structures or parts placed correctly in relation to each other	Mostly incorrect	Mostly correct, but some misplaced	All correct	
Diagram lines are neat, straight and done with a sharp pencil	Not clear or neat or blunt pencil	Clear and neat		
Label lines do not cross over each other	Incorrect	Correct	All correct	
Parts are labelled	Mostly incorrect	Mostly correct with some missing or incorrectly labelled	All correct and labelled	
			Total	/12

A.6 Assessment Rubric 6: Research assignment or Project

Name:

Date:

Task:

Assessment criteria	0	1	2	Comments
Group work (if applicable)	Conflict between members or some did not participate	Some conflict and some members did not always participate	Worked efficiently as a group	
Project layout	No clear or logical organisation	Some parts are clear and logical, while others are not	Clear and logical layout and organisation	
Accuracy	Many errors in content	A few errors in content	Content is accurate	
Resources used (material or media)	No resources used	Some or limited resources used	A range of resources used	
Standard	Poor standard	Satisfactory	Of a high standard	
Use of time	Did not work efficiently and ran out of time	Worked fairly efficiently	Worked efficiently and finished in time	
			Total	/12

A.7 Assessment Rubric 7: Model

Name:

Date:

Task:

Assessment criteria	0	1	2	Comments
Scientifically accurate	Model inaccurate or incomplete	Mostly accurate, but with some parts missing or incorrect	Accurate, complete and correct.	
Size and scale	Too big or too small, parts not in proportion to each other	Correct size, but some parts too big or too small	Correct size and proportional scale	
Use of colour or contrast	Dull, with little use of contrast	Somewhat colourful	Creative and good use of colour and contrast	
Use of materials	Inappropriate use or only expensive materials used	Satisfactory use of appropriate materials and recyclables where possible	Excellent use of materials and recyclables where appropriate	
Use of a key or explanation	Not present	Present but incomplete or vague	Clear and accurate	
			Total	/10

A.8 Assessment Rubric 8: Poster

Name:

Date:

Task:

Assessment criteria	0	1	2	Comments
Title	Absent	Present, but not sufficiently descriptive	Complete title	
Main points	Not relevant	Some points relevant	All points relevant	
Accuracy of facts	Many incorrect	Mostly correct, but some errors	All correct	
Language and spelling	Many errors	Some errors	No errors	
Organisation and layout	Disorganised and no logic	Organisation partially clear and logical	Excellent, logical layout	
Use of colour	No colour or only one colour	Some use of colour	Effective colour	
Size of text	Text very small	Some text too small	Text appropriate size	
Use of diagrams and pictures	Absent or irrelevant	Present but sometimes irrelevant	Present, relevant and appealing	
Accuracy of diagrams or pictures	Inaccurate	Mostly accurate	Completely accurate	
Impact of poster	Does not make an impact	Makes somewhat of an impact	Eye catching and makes a lasting impact	
Creativeness	Nothing new or original	Some signs of creativity and independent thought	Original and very creative	
			Total	/22

A.9 Assessment Rubric 9: Oral presentation

Name:

Date:

Task:

Assessment criteria	0	1	2	3	Comments
Introducing the topic	Did not do	Present, but with no clear links to content	Present, and links to content being covered	Interesting and catching introduction	
Speed of presentation	Too fast or too slow	Started off too fast or too slow but reaches optimal pace	Good speed throughout		
Pitch and clearness of voice	Too soft or unclear	Started off unclear or too soft, but improved	Speaks clearly and optimal pitch throughout		
Capturing audience's attention and originality	Did not make an impact or no attempt to capture interest	Interesting at times	Sustained interest and stimulating	Sustained interest and stimulating throughout with originality	
Organisation of content during presentation	Illogical or unclear	Clear and mostly logical	Clear and logical throughout		
Factual content	Many errors in content	Some errors in content	All correct		
Concluding remarks	No conclusion or not appropriate	Made a satisfactory conclusion	Insightful/ thought-provoking conclusion		
Answers to educator and class's questions	Was not able to answer questions or gave incorrect answers	Was able to answer recall questions only	Was able to answer recall and application questions		
			Total		/18

A.10 Assessment Rubric 10: Group work

Name:

Date:

Task:

Assessment criteria	0	1	2	3	Comments
Member participation	Very few members participated or one or two members did most of work	Only some members participated	In the beginning only some members participated but then full participation	Full participation throughout	
Discipline within the group	Lack of discipline	Some members disciplined	Most members disciplined	All members disciplined	
Group motivation	Unmotivated or lack focus	Some members motivated, but others lack focus	Most members motivated and focused	All members motivated and focused	
Respect for each other	Show disrespect to each other	Some members showed disrespect	All members are respectful		
Conflict within the group	Considerable conflict and disagreements which were unresolved	Some conflict which was either resolved or unresolved	No conflict or any issues were resolved maturely		
Time management	Disorganised and unable to stick to time frames	Mostly able to work within the given time	Effective use of time to complete the task		
			Total		/15



Image Attribution

1	http://www.siyavula.com	8
2	http://www.thunderboltkids.co.za	8
3	http://www.everythingscience.co.za	8
4	http://www.everythingmaths.co.za	8
5	http://www.flickr.com/photos/shardayyy/8028645604/	161
6	http://www.flickr.com/photos/kalleboo/4057044421/	213
7	http://www.flickr.com/photos/vasenka/6635890033/	213
8	http://www.flickr.com/photos/belobaba/6058142799/	213
9	http://www.flickr.com/photos/grand_canyon_nps/6050775941/	261
10	http://www.flickr.com/photos/crabchick/2567814666/	262
11	http://www.flickr.com/photos/ivanwalsh/4186481991/	262
12	http://commons.wikimedia.org/wiki/File:Soapstone_pot.jpg	265
13	http://en.wikipedia.org/wiki/File:C5%9Awi%C4%99to_%C5%9A%C4%85ska_piec_p.jpg	297

