

SET SEVEN EXAMINATION
PRIMARY SEVEN
MATHEMATICS

Time allowed: 2 hours 30 minutes

Index No.

--	--	--	--	--	--	--	--	--

Candidate's Name: _____

Candidate's Signature: _____

School Name: _____

Read the following instructions carefully:

1. The paper has **two** sections: **A** and **B**
2. Section **A** has 20 short questions (40 marks)
3. Section **B** has 12 questions (60 marks)
4. Answer **ALL** questions. All answers to both Sections A and B must be written in the spaces provided.
5. All answers must be written using a blue or black ball point pen or ink. Diagrams should be drawn in pencil.
6. Unnecessary alteration of work may lead to loss of marks.
7. Any handwriting that cannot be easily read may lead to loss of marks.
8. Do **not** fill anything in the boxes indicated for Examiner's use only.

FOR EXAMINER'S USE ONLY

FOR EXAMINER'S USE ONLY		
Qn. No	MARK	SIGN
1 – 10		
11 – 20		
21 – 30		
31 – 32		
TOTAL		

Turn over

SECTION A: (40 MARKS)

1. Add: 4 2
 + 1 7

2. Form the smallest number using digits below.
2, 1, 9, 4

3. Find the missing numbers in the sequence:
1, 3, 6, 10, _____, _____

4. In the venn diagram below, shade the complement of set **Q**.

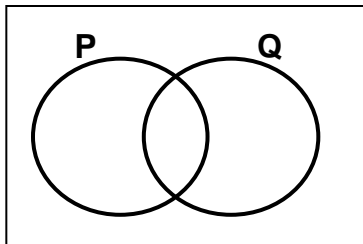

5. Akello's cow gives 8700 millilitres of milk everyday. Express its milk production in litres.

6. What is the value of 4 in 23.748?

7. Work out: $3 + \frac{1}{2}$

8. Moses was preparing for his birthday party and had a bundle of 5000 shilling notes numbered from DL576634 to DL576733. How much money did he use for his party?

9. Work out: $4 + 3 + 5 = \underline{\hspace{2cm}}$ finite 7

10. Study the figure below and find the value of y .

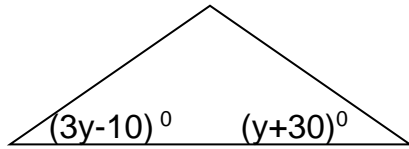

11. Find the average of 3, 12, 8, 17 and 0.

12. Complete the table below.

Ratio	Decimal fraction	Percentage
1:5	_____	_____

13. The number of subsets in set Q is 16. How many elements are in set Q?

14. Work out: $110_{\text{two}} \times 11_{\text{two}}$.

15. The area of the figure below is 32cm^2 . Find its length.

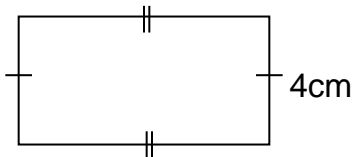

16. Given integers 1, -7 , 0 , 2 and -5 . Find the median.

17. Solve: $\frac{1}{4}n^2 = 9$

18. Using a ruler, a pencil and a pair of compasses only, construct a perpendicular line from **B** to line **PQ**.

• **B**

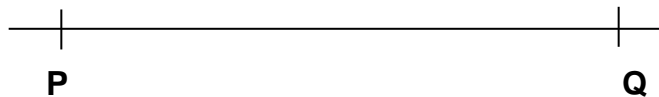

19. What is the least number of sweets that can be shared by either 8 pupils or 9 pupils leaving no remainder.

20. By the time the askari reported for duty in the evening, his watch was reading as shown in the diagram below.

What was the time on the 24 – hour clock?

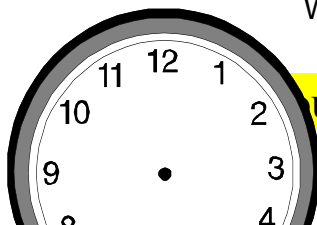



SECTION B: (60 MARKS)

21 (a) Today is Tuesday, what day of the week was it 24 days ago? (2 marks)

(b) Write 780000 in standard form. (1 mark)

(c) Change 23_{ten} to base four. (2 marks)

22. Abraham and Paul shared some money in the ratio 3:5 respectively. If Paul got Sh. 60000;

(a) How much did Abraham get? (2 marks)

(b) How much money was shared? (2 marks)

23. The table below shows the marks scored by pupils in a mini test.

Marks	80	70	50	30
No. of pupils	III	II	I	IIII

(a) How many pupils did the test? (1 mark)

(b) Find the median. (2 marks)

(c) Find the average mark. (2 marks)

24. Dan went to the market with sh. 50000 to buy the items shown in the table below.

Item	Quantity	Unit cost	Total cost
Meat	2kg	sh. 8000	sh. _____
Rice	_____ kg	sh. 2500	sh. 10000
Sugar	1 ½ kg	sh. _____	sh. 4500
Onions	500g	sh. 3000	sh. _____
Total			sh. _____

- (a) Complete the table. (1 mark each)
- (b) If he was given a discount of 20% on his total expenditure, how much was the discount? (1 mark)

25. In a class of 50 pupils, 28 like Math (M), 23 pupils like English (E), P pupils like both subjects while 3 pupils like neither of the two subjects.

- (a) Represent the information on the venn diagram. (3 marks)

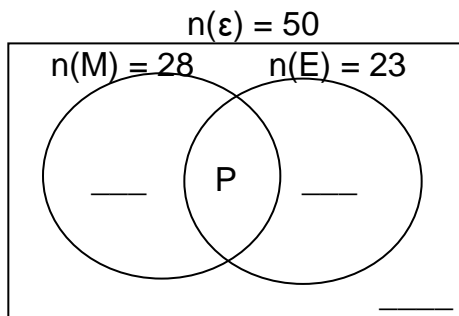

- (b) How many pupils like both subjects? (2 marks)

26 (a) Using a ruler, a pencil and a pair of compasses only, construct a parallelogram PQRS in which $PQ = 7\text{cm}$, $QR = 5\text{cm}$ and angle $SPQ = 60^\circ$. (4 marks)

(b) Measure the length of diagonal PR. (1 mark)

27 (a) In a rally, a car covered 200m in 4 seconds. Calculate its speed in Km/hr. (2 marks)

(b) A car covered a distance of 85km, starting the journey at 11:00 a.m. and ending at 1:30 a.m. Calculate its average speed. (3 marks)

28 (a) Simplify: $\frac{0.42 \times 2.4}{0.7 \times 0.6}$ (3 marks)

(b) Work out: $\frac{2}{3}$ of $2\frac{1}{2} \div 1\frac{2}{5}$ (2 marks)

29 (a) In the triangle below, find the length of QS. (2 marks)

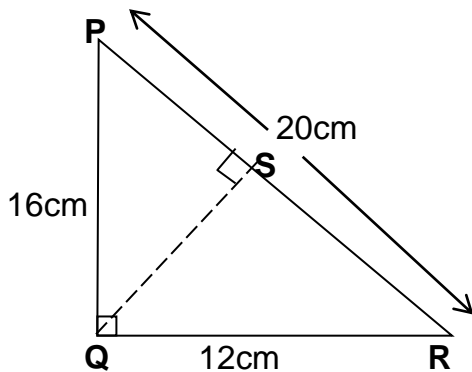

(b) The area of the shaded face is 12cm^2 . Calculate volume. (2 marks)

30 (a) Solve: $\frac{12}{x} + 2 = 6$ (2 marks)

(b) The number of boys in a school is less the number of girls by 60. If there are 300 pupils in the school, how many boys are there? (3 marks)

31. Use the figure below to answer the questions that follow.

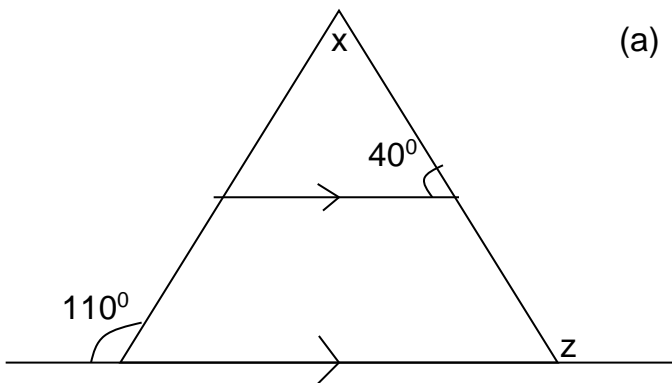

(a) Find the value of x. (3 marks)

(b) Find the size of angle z. (2 marks)

32. In a class, Mary scored 40 marks, Tom scored 20 marks, Musisi scored 10 marks and Bua 30 marks. Put the above information on a pie chart. (6 marks)